











BUSSOLE

PAG	698	BUSSOLE PER PRIGIONIERI	
PAG	704	ESTRATTORI	
PAG	709	BUSSOLE PER BULLONI DI SICUREZZA	
PAG	720	CASSETTE E GUIDE	
PAG	722	QUADRO 1/4" <i>Koken</i>	
PAG	736	QUADRO 1/4" 	
PAG	761	QUADRO 1/4" IMPACT	
PAG	769	QUADRO 3/8" <i>Koken</i>	
PAG	790	QUADRO 3/8" 	
PAG	812	QUADRO 3/8" IMPACT	
PAG	833	QUADRO 1/2" <i>Koken</i>	
PAG	852	QUADRO 1/2" 	
PAG	912	QUADRO 1/2" IMPACT	
PAG	954	QUADRO 5/8" IMPACT	
PAG	956	QUADRO 3/4" <i>Koken</i>	
PAG	962	QUADRO 3/4" 	
PAG	967	QUADRO 3/4" IMPACT	
PAG	990	QUADRO 1" <i>Koken</i>	
PAG	993	QUADRO 1" 	
PAG	995	QUADRO 1" IMPACT	
PAG	1010	QUADRO 1"-1/2" IMPACT	
PAG	1016	QUADRO 2"-1/2" IMPACT	
PAG	764	RIDUZIONI	
PAG	766	SPINE E ANELLI	

10 BUSSOLE PER PRIGIONIERI

BUSSOLE PER PRIGIONIERI



BGS 9373-12 BGS 9373-13



PRO+

BGS articolo	DESCRIZIONE
BGS 9373	1/6 MODULO PER CARRELLO: SET 7 PEZZI, PER PULIZIA PRIGIONIERI

CARATTERISTICHE

- per una rapida pulizia dei prigionieri
- adattatore rapido con attacco quadro da 1/2"
- adattatore quadro 1/2" - esagonale 1/4", per poter utilizzare le spazzole con trapano a batteria
- comprende 5 spazzole per le seguenti dimensioni:
 - 12 mm (7/16")
 - 13 mm (1/2")
 - 14 mm (9/16")
 - 16 mm (5/8")
 - 22 mm (7/8")
- peso: 440 g
- **dimensioni:** (lunghezza x profondità x altezza) **189 x 136 x 32 mm**

RICAMBI

BGS articolo	DESCRIZIONE
BGS 9373-12	SPAZZOLA 12 MM (7/16")
BGS 9373-13	SPAZZOLA 13 MM (1/2")
BGS 9373-14	SPAZZOLA 14 MM (9/16")
BGS 9373-16	SPAZZOLA 16 MM (5/8")
BGS 9373-22	SPAZZOLA 22 MM (7/8")

ANTIGRIPPAGGIO

ESAGONO 1/4" E

CHIAVE AVVITA PRIGIONIERI CON SGANCIO RAPIDO ANTIGRIPPAGGIO

attacco: DIN 3126, E 6,35
impronta: Ø FILETTO

FEARTEC articolo	Ø Filetto	L mm	📦
AP 1/4" SP 6	M 6x1	60	1
AP 1/4" SP 8	M 8x1,25	60	1

ANTIGRIPPAGGIO

ESAGONO 12 mm. FIAM-OBER

CHIAVE AVVITA PRIGIONIERI CON SGANCIO RAPIDO ANTIGRIPPAGGIO

attacco: 12 mm FIAM-OBER
impronta: Ø FILETTO

FEARTEC articolo	Ø Filetto	L mm	📦
CP 2120061	M 6x1	60	1
CP 2120081	M 8x1,25	60	1
CP 2120150	M 10x1,5	60	1
CP 2120175	M 12x1,75	60	1

ANTIGRIPPAGGIO

3/8"

BUSSOLE FILETTATE AVVITA PRIGIONIERI A SGANCIO RAPIDO ANTIGRIPPAGGIO

attacco: 3/8"
impronta: FILETTO

FEARTEC articolo	mm	L mm	📦
900659	M 6 x 1	59	1
900859	M 8 x 1,25	59	1
901059	M 10 x 1,5	59	1

ANTIGRIPPAGGIO

1/2"

BUSSOLE FILETTATE AVVITA PRIGIONIERI A SGANCIO RAPIDO ANTIGRIPPAGGIO

attacco: 1/2"
impronta: FILETTO

FEARTEC articolo	mm	L mm	📦
901800	M 8 x 1,25	75	1
902100	M 10 x 1,5	75	1
902200	M 12 x 1,75	75	1

ANTIGRIPPAGGIO

JAPAN

3/8"

BUSSELA AVVITA PRIGIONIERI ATTACCO 3/8" POWER IMPACT CON SGANCIO RAPIDO ANTIGRIPPAGGIO

Kokon articolo	mm	D1 mm	L mm	📦
23103M-6X1.0	6X1.0	11.1	53	1
23103M-8X1.25	8X1.25	13.6	55	1
23103M-10X1.25	10X1.25	16	57	1
23103M-10X1.5	10X1.5	16	57	1

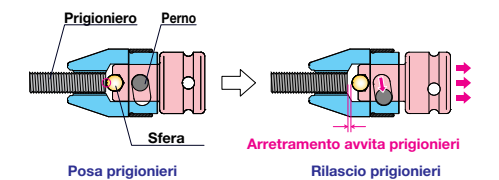

Il rilascio del prigioniero avviene facilmente ruotando in senso antiorario la bussola.

ANTIGRIPPAGGIO

JAPAN

1/2"

BUSSELA AVVITA PRIGIONIERI ATTACCO 1/2" POWER IMPACT CON SGANCIO RAPIDO ANTIGRIPPAGGIO

Kokon articolo	mm	D1 mm	L mm	📦
24103M-8X1.25	8X1.25	15.4	62	1
24103M-10X1.25	10X1.25	17.8	65	1
24103M-10X1.5	10X1.5	17.8	65	1
24103M-12X1.75	12X1.75	20.2	67	1



BUSSOLA FILETTATA AVVITA PRIGIONIERI CON ESTREMITÀ INTERNA DELLA BUSSOLE SFERICA

attacco: 12 mm FIAM-OBER
impronta: Ø FILETTO

FEIMEC articolo	Ø Filetto	L mm	
BP 120031	M 3X0,5	40	1
BP 120041	M 4X0,7	40	1
BP 120051	M 5X0,8	40	1
BP 120061	M 6X1,0	40	1
BP 120081	M 8X1,25	40	1
BP 120181	M 8X1	40	1
BP 120125	M 10X1,25	40	1
BP 120150	M 10X1,5	40	1
BP 121125	M 12X1,25	40	1
BP 120175	M 12X1,75	40	1
BP 120145	M 14X1,50	40	1
BP 120142	M 14X2,00	40	1
BP 120162	M 16X2,00	40	1
BP 120185	M 18X2,50	40	1



CHIAVE AVVITA PRIGIONIERI - BARRE FILETTATE ESTREMITÀ INTERNA DELLA BUSSOLE SFERICA

attacco: DIN 3126, E 6,35
impronta: Ø FILETTO

FEIMEC articolo	Ø Filetto	L mm	
AP 3	M 3 x 0,5	50	1
AP 4	M 4 x 0,7	50	1
AP 5	M 5 x 0,8	50	1
AP 6	M 6 x 1,0	50	1
AP 8	M 8 x 1,25	50	1
AP 10	M 10 x 1,50	50	1
AP 12	M 12 x 1,75	50	1



BUSSOLE FILETTATE AVVITA PRIGIONIERI + SFERA INTERNA

attacco: 3/8"

impronta: FILETTO

FEIMEC articolo	mm	L mm	
BA 5	M 5 X 0,8	50	1
BA 6	M 6 X 1	50	1
BA 7	M 7 X 1	50	1
BA 8	M 8 X 1,25	50	1
BA 10	M 10 X 1,5	50	1
BA 10125	M 10 X 1,25	50	1



BUSSOLE FILETTATE AVVITA PRIGIONIERI + SFERA INTERNA

attacco: 1/2"

impronta: FILETTO

FEIMEC articolo	mm	L mm	
BB 6	M 6 x 1	55	1
BB 7	M 7 x 1	55	1
BB 8	M 8 x 1,25	55	1
BB 10	M 10 x 1,5	55	1
BB 12	M 12 x 1,75	55	1
BB 14	M 14 x 2	55	1
BB 16	M 16 x 2	75	1
BB 18	M 18 x 2,5	75	1
BB 20	M 20 x 2,5	75	1
BB 81000	M 8 x 1	55	1
BB 10125	M 10 x 1,25	55	1
BB 12125	M 12 x 1,25	55	1
BB 12150	M 12 x 1,5	55	1
BB 14150	M 14 x 1,5	55	1
BB 16150	M 16 x 1,5	75	1
BB 18150	M 18 x 1,5	75	1
BB 20150	M 20 x 1,5	75	1
BB 22150	M 22 x 1,5	75	1
BB 34100	3/4" x 10 UNC	75	1
BB 58100	5/8" x 11 UNC	75	1
BB 12130	1/2" x 13 UNC	75	1



BUSSOLE FILETTATE AVVITA PRIGIONIERI + SFERA INTERNA

attacco: 3/4"

impronta: FILETTO

FEIMEC articolo	mm	L mm	
BC 16150	M 16 x 1,5	100	1
BC 16200	M 16 x 2,0	100	1
BC 18150	M 18 x 1,5	100	1
BC 18250	M 18 x 2,5	100	1
BC 20150	M 20 x 1,5	100	1
BC 20250	M 20 x 2,5	100	1
BC 22250	M 22 x 2,5	100	1
BC 24300	M 24 x 3,0	100	1
BC 27300	M 27 x 3,0	100	1
BC 30350	M 30 x 3,5	100	1
BC 33350	M 33 x 3,5	100	1
BC 36400	M 36 x 4,0	100	1

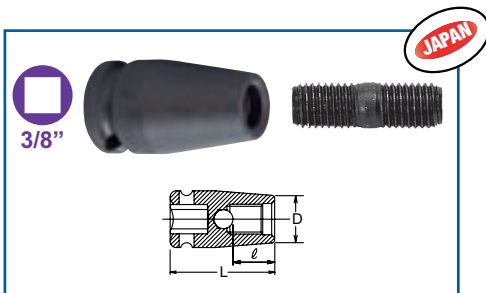

JAPAN

**BUSSOLA AVVITA PRIGIONIERI
ATTACCO 3/8" POWER IMPACT**

Koken articolo	mm	D mm	L mm	
13103M-5X0.8	5X0.8	9.5	32	1
13103M-6X1.0	6X1.0	10.8	32	1
13103M-7X1.0	7X1.0	12.5	32	1
13103M-8X1.25	8X1.25	13.5	35	1
13103M-10X1.25	10X1.25	15.8	35	1
13103M-10X1.5	10X1.5	15.8	35	1

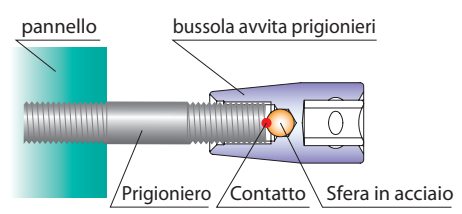

Bussola speciale per avvitare i prigionieri.
La sfera di acciaio all'interno della bussola impedisce il blocco del prigioniero.
Dopo l'avvitamento girare in senso antiorario per rimuovere la bussola.

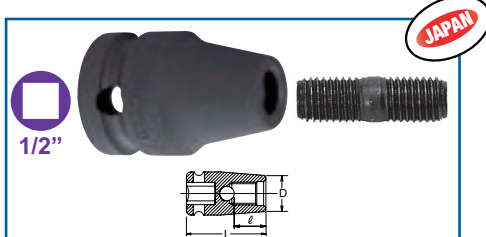

JAPAN

**BUSSOLA AVVITA PRIGIONIERI
ATTACCO 1/2" POWER IMPACT**

Koken articolo	mm	D mm	L mm	
14103M-6X1.0	6X1.0	12	38	1
14103M-7X1.0	7X1.0	13.2	38	1
14103M-8X1.25	8X1.25	14.5	38	1
14103M-10X1.25	10X1.25	17	44	1
14103M-10X1.5	10X1.5	17	44	1
14103M-12X1.25	12X1.25	19.5	44	1
14103M-12X1.75	12X1.75	19.5	44	1
14103M-14X1.5	14X1.5	22	50	1
14103M-14X2.0	14X2.0	22	50	1

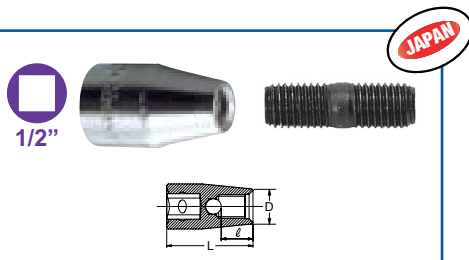

JAPAN

**BUSSOLA AVVITA PRIGIONIERI
ATTACCO 1/2"**

Koken articolo	mm	D mm	L mm	
4103M-6X1.0	6X1.0	10.3	37	1
4103M-7X1.0	7X1.0	11.5	37	1
4103M-8X1.25	8X1.25	13.2	37	1
4103M-10X1.25	10X1.25	15.3	44	1
4103M-10X1.5	10X1.5	15.3	44	1
4103M-12X1.25	12X1.25	17.8	44	1
4103M-12X1.75	12X1.75	17.8	44	1

POLLICI

4103A-1/4(28)	novità	1/4X28	10.7	37	1
4103A-5/16(18)	novità	5/16X18	13.2	37	1
4103A-5/16(24)	novità	5/16X24	13.2	37	1
4103A-3/8(16)	novità	3/8X16	14.6	44	1
4103A-7/16(14)	novità	7/16X14	16.5	44	1
4103A-1/2(13)	novità	1/2X13	19	44	1



JAPAN

Koken articolo	DESCRIZIONE
4203 M	Set 4 pezzi bussole avvita prigionieri
RICAMBI	
BUSSOLE	
4103M	6(1.0), 8(1.25), 10(1.5), 12(1.75)



JAPAN

PASSO FINE

Koken articolo	DESCRIZIONE
4203 MF	Set 4 pezzi bussole avvita prigionieri
RICAMBI	
BUSSOLE	
4103M	6(1.0), 8(1.25), 10(1.25), 12(1.25)

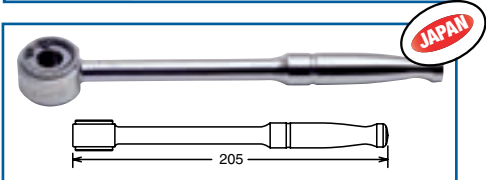

JAPAN

**ESTRATTORE PER PRIGIONIERI
CON IMPUGNATURA**

Koken articolo	mm	D mm	L mm	
141P-6	6	28	205	1
141P-8	8	28	205	1
141P-10	10	32	205	1
141P-12	12	32	205	1



JAPAN

**ESTRATTORE PER PRIGIONIERI
CON IMPUGNATURA**

Koken articolo	mm	D mm	L mm	
141S-6	6	28	120	1
141S-8	8	28	120	1
141S-10	10	32	120	1
141S-12	12	32	120	1
141-6	6	28	205	1
141-8	8	28	205	1
141-10	10	32	205	1
141-12	12	32	205	1



10 BUSSOLE PER PRIGIONIERI

BUSSOLE PER PRIGIONIERI

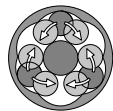
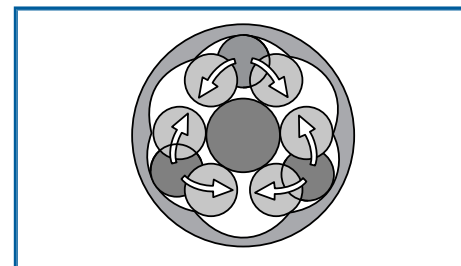

PRO+

CV

ESTRATTORI PER PRIGIONIERI A RULLI

BGS articolo		DESCRIZIONE	MM
BGS 6747		1/4"	2,5 MM
BGS 6748		1/4"	3 MM
BGS 6749		1/4"	3,5 MM
BGS 65515-5		3/8"	5 MM
BGS 1883		1/2"	6 MM
BGS 65515-7		1/2"	7 MM
BGS 1884		1/2"	8 MM
BGS 65515-9		1/2"	9 MM
BGS 1885		1/2"	10 MM
BGS 65515-10.5		1/2"	10.5 MM
BGS 65515-11		1/2"	11 MM
BGS 1886		1/2"	12 MM
BGS 65515-14		24 MM	14 MM
BGS 65515-16		24 MM	16 MM

CARATTERISTICHE

- lunghezza 60 mm
- coppia massima 20 Nm
- attacco:
 - quadro femmina + esagono di manovra esterno
 - solo BGS 65515-14 e BGS 65515-16 esagono di manovra esterno 24 mm (senza quadro femmina)



1/2"

PRO+

CV

BGS articolo	DESCRIZIONE
BGS 65515	SET 11 PEZZI, ESTRATTORI A RULLI PER PRIGIONIERI A RULLI

CARATTERISTICHE

- 5 - 6 - 7 - 8 - 9 - 10 - 10,5 - 11 - 12 - 14 e 16 mm
- tutti gli estrattori con attacco quadro femmina 1/2" ed esagono esterno
- coppia massima 20 Nm
- peso: 2,3 kg



1/2"

PRO+

CV

BGS articolo	DESCRIZIONE
BGS 1882	SET 4 PEZZI, ESTRATTORI PRIGIONIERI A RULLI, ATT. 1/2"

CARATTERISTICHE

- attacco quadro 1/2"
- dimensioni: 6-8-10-12 mm
- peso: 1,2 kg



PRO+

CV

BGS articolo	DESCRIZIONE
BGS 65505	SET 5 PEZZI, ESTRATTORI PRIGIONIERI A RULLI

CARATTERISTICHE

- contenuto:
 - 1 chiave a cricchetto reversibile a doppio anello 14 x 17 mm
 - 4 estrattori prigionieri 6, 8, 10 e 12 mm
- peso: 870 g

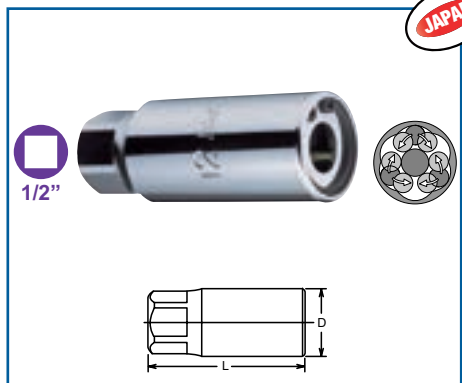

JAPAN

**ESTRATTORE PER PRIGIONIERI A RULLI
ATTACCO 1/2"**

Kokon articolo	mm	D mm	L mm	
4100M-5	5.0	24	65	1
4100M-6	6.0	24	65	1
4100M-7	7.0	24	65	1
4100M-8	8.0	24	65	1
4100M-9	9.0	28	75	1
4100M-10	10.0	28	75	1
4100M-10.5	10.5	28	75	1
4100M-11	11.0	28	75	1
4100M-12	12.0	28	75	1
4100M-14	14.0	34	75	1
4100M-16	16.0	34	75	1

POLLICI

4100A-1/4	1/4	24	65	1
4100A-5/16	5/16	24	65	1
4100A-3/8	3/8	28	75	1
4100A-7/16	7/16	28	75	1
4100A-1/2	1/2	28	75	1
4100A-9/16	9/16	34	75	1
4100A-5/8	5/8	34	75	1

GLI ART. 4100M-16 E 4100A-5/8 NON HANNO ATTACCO QUADRO DA 1/2" MA SOLO ATTACCO ESAGONALE DA 27 Mm

Tolleranze Estrattori 4100M-4100A			
4100M mm		4100A pollici	4100A mm
5	4.7 - 5	1/4	6 - 6.4
6	5.6 - 6	5/16	7.6 - 8
7	6.6 - 7	3/8	9 - 9.6
8	7.6 - 8	7/16	10.5 - 11.1
9	8.4 - 9	1/2	12.1 - 12.7
10	9.4 - 10	9/16	13.5 - 14.3
10.5	9.9 - 10.5	5/8	15.2 - 16
11	10.4 - 11		
12	11.4 - 12		
14	13.2 - 14		
16	15.2 - 16		

BUSSOLA ESTRATTORE	2 mm	3 mm	4 mm	6 mm	8 mm	10 mm	12 mm	14 mm	16 mm
FILETTO mm	M5	M6	M8	M10-M12	M14-M16	M18-M20	M22-M24	M27-M30	M33
PUNTA TRAP. mm	2,4-2,6	3,2-3,5	4,2-4,5	6,2-6,5	8,2-8,5	10,2-10,5	12,2-12,5	14,2-14,5	16,2-16,5



Kokon articolo	DESCRIZIONE
4211 M	Cassetta in metallo 4 Pz. 220 x 85 x h45
RICAMBI	
4100M	6, 8, 10, 12

POLLICI

JAPAN



Kokon articolo	DESCRIZIONE
4211 A	Cassetta in metallo 5 Pz. 220 x 85 x h45
RICAMBI	
4100A	1/4, 5/16, 3/8, 1/2

JAPAN



Tolleranze Estrattori 14100M-14100A			
14100M mm		14100A pollici	14100A mm
6	5.6 - 6	1/4	6 - 6.4
7	6.6 - 7	5/16	7.6 - 8
8	7.6 - 8	3/8	9 - 9.6
9	8.4 - 9	7/16	10.5 - 11.1
10	9.4 - 10	1/2	12.1 - 12.7
12	11.4 - 12		

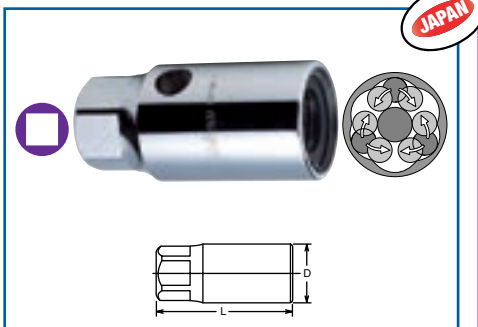

JAPAN

ESTRATTORE PER PRIGIONIERI A RULLI

Kokon articolo	mm	ATT.	D mm	L mm
6100M-18	18	3/4"	48	100
6100M-20	20	3/4"	48	100
6100M-22	22	36 mm	48	100
6100M-24	24	36 mm	48	100
6100M-27	27	46 mm	63	125
6100M-28	28	46 mm	63	125
6100M-29	29	46 mm	63	125
6100M-30	30	46 mm	63	125

Tolleranze Estrattori 6100M	
6100M mm	
18	16.9 - 18
20	18.8 - 20
22	20.8 - 22
24	22.7 - 24
27	25.7 - 27
28	26.7 - 28
29	27.6 - 29
30	28.6 - 30



JAPAN

**ESTRATTORE PER PRIGIONIERI A RULLI
ATTACCO 1/2" IMPACT**

Kokon articolo	mm	D mm	L mm	
14100M-6	6	24	48	1
14100M-7	7	24	48	1
14100M-8	8	24	48	1
14100M-9	9	28	48	1
14100M-10	10	28	48	1
14100M-12	12	28	48	1

POLLICI

14100A-1/4	1/4"	24	48	1
14100A-5/16	5/16"	24	48	1
14100A-3/8	3/8"	28	48	1
14100A-7/16	7/16"	28	48	1
14100A-1/2	1/2"	28	48	1

BUSSOLE PER PRIGIONIERI

profilo speciale

BGS articolo	DESCRIZIONE
5538	SET 5 PEZZI, ESTRATTORI PER VITI E BULLONI SPEZZATI

CARATTERISTICHE	
<ul style="list-style-type: none"> in Cromo-Molibdeno, finitura fosfata per la rimozione di viti, tubi, bulloni e prigionieri spezzati misure: <ul style="list-style-type: none"> - metriche: 3 - 5 - 6 - 8 - 9 mm - pollici: 1/8" - 3/16" - 15/64" - 5/16" - 3/8" 	

BGS articolo	DESCRIZIONE
BGS 5282	SET 5 PEZZI, ESTRATTORI PER VITI

CARATTERISTICHE	
<ul style="list-style-type: none"> acciaio al carbonio per tutti i tipi di viti a croce, TORX e con esagono incassato 5 formati diversi per utilizzo con trapano elettrico, max. 250 giri/min peso: 170 g 	

BGS articolo	DESCRIZIONE
BGS 50410	SET 5 PEZZI, ESTRATTORI PER VITI

CARATTERISTICHE	
<ul style="list-style-type: none"> per tutti i tipi di viti a croce, TORX e esagonali adatto per utilizzo con trapano elettrico a velocità regolabile attacco esagonale 1/4" comprende 5 estrattori: 0-0-1-2-3 <ul style="list-style-type: none"> - # 0 per 6 mm, velocità 700 - 800 giri al minuto - # 1 per 8 mm velocità 600-700 giri al minuto - # 2 per 10 mm, velocità 500 - 600 giri al minuto - # 3 per 12 mm, velocità 400-500 giri al minuto peso: 160 g 	

BGS articolo	DESCRIZIONE
BGS 9170	SET 11 PEZZI, ESTRATTORI PER VITI TORX DANNEGGIATE, TX10-TX55

CARATTERISTICHE	
<ul style="list-style-type: none"> consente la rimozione di viti con impronta Torx danneggiata comprende: <ul style="list-style-type: none"> - inserti con attacco esagonale 1/4", lungh. 50 mm, per Torx: TX10 - TX15 - TX20 - TX25 - TX30 - TX40 - inserti con attacco esagonale 10 mm (3/8"), lungh. 38 mm, per Torx: TX45 - TX50 - TX55 - adattatore quadro femmina 1/2", per inserti con attacco esagonale 10 mm (3/8") peso: 310 g 	

BGS articolo	DESCRIZIONE
BGS 5284	SET 7 PEZZI, ESTRATTORI PER VITI TORX DANNEGGIATE, TX10-TX40, ATT. 1/4", 50 MM

CARATTERISTICHE	
<ul style="list-style-type: none"> consente la rimozione di viti con impronta Torx danneggiata comprende inserti con attacco esagonale 1/4", lungh. 50 mm, per Torx: TX10 - TX15 - TX20 - TX25 - TX27 - TX30 - TX40 peso: 120 g 	



ESAGONO
ESAGONO 1/4" E
PRO+

BGS articolo	DESCRIZIONE
BGS 5289	SET 7 PEZZI, ESTRATTORI PER VITI ESAGONALI DANNEGGIATE, 1,5-6 MM, ATT. 1/4", 50 MM

CARATTERISTICHE

- consente la rimozione di viti con impronta Esagonale danneggiata
- comprende inserti con attacco esagonale 1/4", lungh. 50 mm, per Esagono: 1,5 - 2 - 2,5 - 3 - 4 - 5 - 6 mm
- peso: 120 g



novità

CV 1/2" PRO+

BGS articolo	DESCRIZIONE
BGS 7004	SET 7 PEZZI, DI ESTRATTORI PER VITI, ATT. 1/2", PER ESAGONI INTERNI DANNEGGIATI, 4 - 12 MM

CARATTERISTICHE

- per la rimozione di viti con esagono interno rovinato
- impronta speciale ritorta sinistra, con forma conica
- con scanalatura e foro per spina
- su guida metallica
- attacco quadro femmina 1/2"
- materiale: acciaio al cromo vanadio
- finitura nera fosfata
- **lunghezza: 78 mm**
- comprende:
 - 1 estrattore, 4 mm (BGS 7004-4)
 - 1 estrattore, 5 mm (BGS 7004-5)
 - 1 estrattore, 6 mm (BGS 7004-6)
 - 1 estrattore, 7 mm (BGS 7004-7)
 - 1 estrattore, 8 mm (BGS 7004-8)
 - 1 estrattore, 10 mm (BGS 7004-10)
 - 1 estrattore, 12 mm (BGS 7004-12)
- peso 800 g



ESAGONO

1/4" 3/8" PRO+ CV S2

BGS articolo	DESCRIZIONE
BGS 6847	SET 8 PEZZI, ESTRATTORI PER VITI ESAGONALI DANNEGGIATE, 3-10 MM, ATT. 1/4" & 3/8"

CARATTERISTICHE

- consente la rimozione di viti con impronta Esagonale danneggiata
- su guida metallica
- comprende:
 - 1 estrattore att. 1/4", esagonale 3 mm
 - 1 estrattore att. 1/4", esagonale 4 mm
 - 1 estrattore att. 1/4", esagonale 5 mm
 - 1 estrattore att. 1/4", esagonale 6 mm
 - 1 estrattore att. 3/8", esagonale 7 mm
 - 1 estrattore att. 3/8", esagonale 8 mm
 - 1 estrattore att. 3/8", esagonale 9 mm
 - 1 estrattore att. 3/8", esagonale 10 mm
- peso: 310 g



novità

CV 1/2" PRO+

ESTRATTORI PER VITI, ATT. 1/2", PER VITI CON ESAGONO INTERNO DANNEGGIATO

BGS articolo	DESCRIZIONE
BGS 7004-4	4 MM
BGS 7004-5	5 MM
BGS 7004-6	6 MM
BGS 7004-7	7 MM
BGS 7004-8	8 MM
BGS 7004-10	10 MM
BGS 7004-12	12 MM

CARATTERISTICHE

- per la rimozione di viti con esagono interno rovinato
- impronta speciale ritorta sinistra, con forma conica
- con scanalatura e foro per spina
- su guida metallica
- attacco quadro femmina 1/2"
- materiale: acciaio al cromo vanadio
- finitura: nera fosfata
- **lunghezza: 78 mm**



PRO+ CV

BGS articolo	DESCRIZIONE
BGS 8549	SET 6 PEZZI, ESTRATTORI PER VITI

CARATTERISTICHE

- per estrarre viti danneggiate
- misure: 1 - 2 - 3 - 4 - 5 e 6
- attacco quadro
- peso: 250 g



PRO+

BGS articolo BGS 1895	DESCRIZIONE	
	SET 5 PEZZI, ESTRATTORI VITI, DIMENSIONI 1-5	

CARATTERISTICHE	
<ul style="list-style-type: none"> per la rimozione di viti spezzate per viti delle seguenti misure: <ul style="list-style-type: none"> - 3 - 6 mm (1/8" - 1/4") - 6 - 8 mm (1/4" - 5/16") - 8 - 11 mm (5/16" - 7/16") - 11 - 14 mm (7/16" - 9/16") - 14 - 19 mm (9/16" - 3/4") in acciaio al carbonio In custodia in plastica peso: 120 g 	



PRO+

BGS articolo BGS 1896	DESCRIZIONE	
	SET 6 PEZZI, ESTRATTORI VITI, DIMENSIONI 1-6	

CARATTERISTICHE	
<ul style="list-style-type: none"> per la rimozione di viti spezzate per viti delle seguenti misure: <ul style="list-style-type: none"> - 3 - 6 mm (1/8" - 1/4") - 6 - 8 mm (1/4" - 5/16") - 8 - 11 mm (5/16" - 7/16") - 11 - 14 mm (7/16" - 9/16") - 14 - 19 mm (9/16" - 3/4") - 19 - 25 mm (3/4" - 1") in acciaio al carbonio In custodia in plastica peso: 230 g 	



BGS articolo BGS 1897	DESCRIZIONE	
	SET 8 PEZZI, ESTRATTORI VITI	

CARATTERISTICHE	
<ul style="list-style-type: none"> per viti delle seguenti misure: M3-6, M6-8, M8-11, M11-14, M14-18, M18-25, M25-35, M35-50 peso: 800 g 	



PRO+

BGS articolo BGS 8462	DESCRIZIONE	
	SET 25 PEZZI, ESTRATTORI HSS PER VITI	

CARATTERISTICHE	
<ul style="list-style-type: none"> per l'estrazione di viti e perni aiuta a ridurre i tempi ed i costi di lavorazione contenuto: <ul style="list-style-type: none"> - 5 punte HSS: 3,2, - 4,8 - 6,4 - 8,0 - 8,7 mm - 10 boccole guida per punte - 5 cacciaspine - 5 adattatori in acciaio HSS peso: 890 g 	

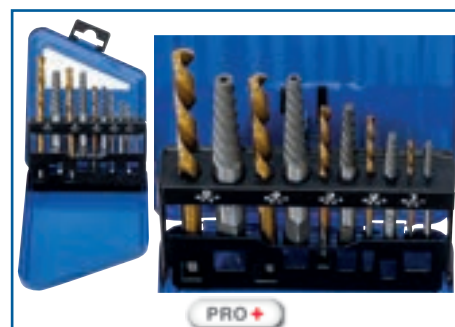

PRO+

BGS articolo BGS 6780	DESCRIZIONE	
	SET 10 PEZZI, ESTRATTORI E PUNTE HSS, TAGLIO SINISTRO, AL NITRURO DI TITANIO, 2 - 7,5 MM	

CARATTERISTICHE	
<ul style="list-style-type: none"> per la rimozione di perni e viti rotti con filettatura destra contiene punte sinistre rivestite in titanio, è possibile estrarre il bullone rotto durante la foratura gli estrattori a vite hanno una scanalatura a spirale con torsione a sinistra, scavano automaticamente più in profondità nel bullone filettato rotto quando avvitati comprende: <ul style="list-style-type: none"> - 5 estrattori a spirale - 5 punte, taglio sinistro HSS - misure: 2 mm (5/64") - 2,8 mm (7/64") 4 mm (5/32") - 6,4 mm (1/4") 7,5 mm (19/64") peso: 380 g 	

JAPAN



3/8

BOLT TWISTER®

BUSSOLA ESTRATTORE PER VITI SPEZZATE ATTACCO 3/8"



Koken articolo	D mm	L mm	
3129-32-2	2	32	1
3129-32-3	3	32	1
3129-32-4	4	32	1
3129-32-6	6	32	1
3129-32-8	8	32	1
3129-32-10	10	32	1

JAPAN



3/8

BOLT TWISTER®

BUSSOLA ESTRATTORE PER VITI SPEZZATE ATTACCO 3/8" TIPO LUNGO

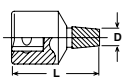

Koken articolo	D mm	L mm	
3129-60-2	2	60	1
3129-60-3	3	60	1
3129-60-4	4	60	1
3129-60-6	6	60	1
3129-60-8	8	60	1
3129-60-10	10	60	1

JAPAN



1/2"

BOLT TWISTER®

BUSSOLA ESTRATTORE PER VITI SPEZZATE ATTACCO 1/2"



Koken articolo	D mm	L mm	
4129-37-8	8	37	1
4129-37-10	10	37	1
4129-37-12	12	37	1
4129-37-14	14	37	1
4129-37-16	16	37	1

JAPAN



Koken articolo	DESCRIZIONE
RS 3129/6-L32	Set 6 pezzi
RICAMBI	
3129-32	2, 3, 4, 6, 8, 10

JAPAN



Koken articolo	DESCRIZIONE
RS 3129/6-L60	Set 6 pezzi
RICAMBI	
3129-60	2, 3, 4, 6, 8, 10

JAPAN



Koken articolo	DESCRIZIONE
RS 4129/5-L37	Set 5 pezzi
RICAMBI	
4129-37	8, 10, 12, 14, 16

JAPAN



1/2"

BOLT TWISTER®

BUSSOLA ESTRATTORE PER VITI SPEZZATE - ATTACCO 1/2" TIPO LUNGO



Koken articolo	D mm	L mm	
4129-75-8	8	75	1
4129-75-10	10	75	1
4129-75-12	12	75	1
4129-75-14	14	75	1
4129-75-16	16	75	1

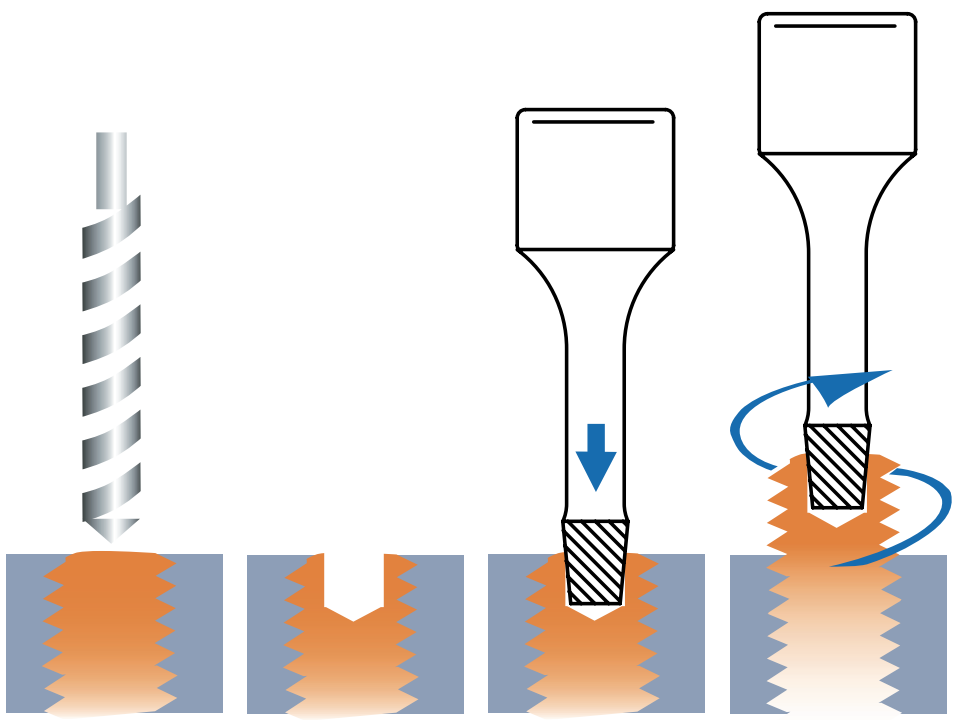

JAPAN



Koken articolo	DESCRIZIONE
RS 4129/5-L75	Set 5 pezzi
RICAMBI	
4129-75	8, 10, 12, 14, 16



 3/8"



BGS articolo	DESCRIZIONE	
BGS 5281	SET 6 PEZZI, ESTRATTORI A SPIRALE, 2-10 MM, ATT. 3/8"	

CARATTERISTICHE

- 2-3-4-6-8-10 mm
- per l'allentamento di viti e dadi danneggiati
- idonee per avvitatori
- l'innovativo profilo a spirale penetra nella testa di una vite o di un dado danneggiati, consentendo così di svitarli in sicurezza
- peso: 520 g

RICAMBI

BGS articolo	DESCRIZIONE	
BGS 5281-2	ESTRATORE, 2 MM	
BGS 5281-3	ESTRATORE, 3 MM	
BGS 5281-4	ESTRATORE, 4 MM	
BGS 5281-6	ESTRATORE, 6 MM	
BGS 5281-8	ESTRATORE, 8 MM	
BGS 5281-10	ESTRATORE, 10 MM	



 ESAGONO
 13 mm



BGS articolo	DESCRIZIONE	
BGS 8547	SET 10 PEZZI, ESTRATTORI PER VITI	

CARATTERISTICHE

- per l'estrazione di viti con testa danneggiata
- per viti esagonali, Torx e Taglio
- attacco esagonale da 13 mm
- estrattore con attacco esagonale delle seguenti misure: 3 - 4 - 5,5 - 6 - 7 - 8 - 9 - 10 e 11 mm
- anche per viti con misure in pollici:
1/8" - 5/32" - 3/16" - 7/32" - 1/4" - 9/32" - 5/16"
11/32" - 3/8" e 13/32"
- peso: 550 g

NOTE

1/4" NUT TWISTER®

BUSSOLA ESTRATTORE PER DADI BULLONI E BORCHIE ATTACCO 1/4"



Koken articolo	Ø mm	D mm	ℓ mm	L mm	
2127-4	4	7	4	23	1
2127-4.5	4.5	7.4	4	23	1
2127-5	5	8	5	23	1
2127-5.5	5.5	8.8	5	23	1
2127-6	6	9.5	6	23	1
2127-7	7	10.9	6	23	1
2127-8	8	11.5	8	23	1
2127-9	9	13	8	23	1
2127-9.5	9.5	13.8	10	23	1
2127-10	10	14.8	10	23	1

3/8" NUT TWISTER®

BUSSOLA ESTRATTORE PER DADI BULLONI E BORCHIE ATTACCO 3/8"



Koken articolo	Ø mm	D mm	ℓ mm	L mm	
3127-8	8	11.5	8	32	1
3127-9	9	13.0	8	32	1
3127-9.5	9.5	13.8	8	32	1
3127-10	10	14.8	10	32	1
3127-11	11	16.0	10	32	1
3127-12	12	17.0	12	32	1
3127-13	13	18.5	12	32	1
3127-14	14	19.7	14	32	1
3127-15	15	20.7	14	32	1
3127-16	16	22.2	14	32	1
3127-17	17	23.5	16	35	1
3127-19	19	26.0	16	35	1

1/2" NUT TWISTER®

BUSSOLA ESTRATTORE PER DADI BULLONI E BORCHIE ATTACCO 1/2"



Koken articolo	Ø mm	D mm	ℓ mm	L mm	
4127-14	14	19.7	14	42	1
4127-17	17	23.5	16	42	1
4127-19	19	26.0	16	42	1
4127-21	21	28.0	17	42	1
4127-22	22	29.5	17	42	1
4127-24	24	32.0	18	42	1
4127-25.4	25.4	33.5	18	42	1

3/8" NUT TWISTER®

BUSSOLA ESTRATTORE PER DADI BULLONI E BORCHIE ATTACCO 3/8" - TIPO LUNGO



Koken articolo	Ø mm	D mm	ℓ mm	L mm	
3128-8	8	11.5	6	80	1
3128-9	9	13.0	6	80	1
3128-10	10	14.8	8	80	1
3128-11	11	16.0	8	80	1
3128-12	12	17.0	10	80	1
3128-13	13	18.5	10	80	1
3128-14	14	19.7	12	80	1

1/2" NUT TWISTER®

BUSSOLA ESTRATTORE PER DADI BULLONI E BORCHIE ATTACCO 1/2" - TIPO LUNGO



Koken articolo	Ø mm	D mm	ℓ mm	L mm	
4128-17	17	23.5	16	120	1
4128-19	19	26.0	16	120	1
4128-21	21	28.0	17	120	1
4128-22	22	29.5	17	120	1



BOLT TWISTER®
Soluzione semplice e efficace per la rimozione di bulloni con la testa rotta. Praticare un foro nel centro del filetto e svitare. I bordi taglienti a spirale lo rimuoveranno facilmente.

ESTRATTORI A BUSSELLA DOPPI PER BULLONI DI SICUREZZA





Koken articolo	Ø mm	D ₁ mm	D ₂ mm	L mm	
14124-21x24.5	21x24.5	28	29.5	65	1
14124-26x27.5	26x27.5	31.5	35	65	1

ESTRATTORI A BUSSELLA PER BULLONI DI SICUREZZA

Koken articolo	DESCRIZIONE
14124/3	Set 3 pezzi
RICAMBI	
14124	21x24.5, 26x27.5
ACCESSORI 14760-75B	

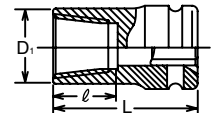
ESTRATTORI A BUSSELLA PER BULLONI DI SICUREZZA



Koken articolo	Ø	D mm	ℓ mm	L mm	
14124-17	17	20.5	15	50	1
14124-18	18	21	15	50	1
14124-18.5	18.5	23	15	50	1
14124-19	19	25	20.5	50	1
14124-21	21	28	20.5	50	1
14124-24.5	24.5	29.5	23	50	1
14124-26	26	31.5	23	50	1
14124-27.5	27.5	35	23	50	1



JAPAN

Koken articolo	DESCRIZIONE
RS 14124/7	Set 7 pezzi
RICAMBI	
14124	Ø18, Ø18.5, Ø19, Ø21, Ø24.5, Ø26, Ø27.5



1/2"

BGS articolo	DESCRIZIONE
BGS 8656	SET 10 PEZZI, ESTRATTORI, ATT. 1/2"

PRO+

CARATTERISTICHE	
<ul style="list-style-type: none"> • estrattori conici lunghezza 60 mm • estrattori conici • estrattori conici con Ø (max-min): Ø 18.3x16.4 - Ø 19.5x17.6 - Ø 20.4x18.5 - Ø 21.6x19.7 - Ø 22.5x20.6 - Ø 23.6x21.7 - Ø 24.5x22.6 - Ø 25.5x23.6 mm • con 2 leve di manovra per rimozione bulloni dalla bussola • realizzati in materiale S45C e SCM440 • peso: 2,5 kg 	
RICAMBI	
BGS articolo	DESCRIZIONE
BGS 8656-3	ESTRATT. Ø 18,3 MM
BGS 8656-4	ESTRATT. Ø 19,5 MM
BGS 8656-5	ESTRATT. Ø 20,4 MM
BGS 8656-6	ESTRATT. Ø 21,6 MM
BGS 8656-7	ESTRATT. Ø 22,5 MM
BGS 8656-8	ESTRATT. Ø 23,6 MM
BGS 8656-9	ESTRATT. Ø 24,5 MM
BGS 8656-10	ESTRATT. Ø 25,5 MM



novità

BGS articolo	DESCRIZIONE
BGS 74448	SET 14 PEZZI, ESTRATTORI, ATT. 1/2"

CARATTERISTICHE	
<ul style="list-style-type: none"> • ideali per la rimozione dei bulloni di sicurezza dei cerchi delle ruote senza anello esterno rotante • universali • prevengono danni ai cerchi • estrattori conici • pareti sottili • con 2 perni per la rimozione dei bulloni dagli estrattori • con modulo portautensili in schiuma ad alta resistenza • finitura: fosfatata • comprende: <ul style="list-style-type: none"> - estrattori con Ø interno: 1 x 24 mm, 1 x 26 mm, 1 x 27 mm, 1 x 28 mm, 1 x 28,8 mm, 1 x 30 mm, 1 x 30,8 mm, 1 x 31,8 mm, 1 x 34,8 mm, 1 x 35,8 mm, 1 x 36,8 mm - 2 perni per la rimozione dei bulloni dagli estrattori - 1 perno a percussione per martello pneumatico • peso: 3,9 kg 	



1/2"



CASSETTA 7 BUSSOLE SPECIALI PER SVITARE BULLONI DI SICUREZZA NEI CERCHI IN LEGA
17-18,5-20-21,5-23-24,5-26 MM

attacco: 1/2"

impronta: FILETTO CONICO SINISTRO

articolo	Ø mm	L mm	
523017	17	38	1
523185	18,5	38	1
523200	20	38	1
523215	21,5	38	1
523230	23	38	1
523245	24,5	38	1
523260	26	38	1
523071	CASSETTA 7 PEZZI		1



1/2"



BGS articolo	DESCRIZIONE
BGS 5260	SET 4 PEZZI ESTRATTORI ATT. 1/2"

PRO+ **CROMO**

CARATTERISTICHE	
<ul style="list-style-type: none"> • ideali per l'allentamento di viti e dadi fortemente danneggiati • particolarmente indicate per dadi ruota, dadi di bloccaggio, ecc. • misure 17-18,5-21,5-26 mm • in custodia metallica • peso: 610 g 	

BGS
articolo

BGS 5291

DESCRIZIONE

SET 7 PEZZI, ESTRATTORI 17-26 MM, ATT. 1/2"

CARATTERISTICHE

- per l'allentamento di viti e dadi danneggiati
- per uso con avvitatori
- l'innovativo profilo a spirale penetra nella testa di una vite o di un dado danneggiati, consentendo così di svitarli in sicurezza
- attacco 1/2"
- misure : 17 - 18.5 - 20 - 21.5 - 23 - 24.5 - 26 mm
- finitura nera
- peso: 1,2 kg

1/2" CRO MO PRO+

PRO+ CRO MO

ESTRATTORI

BGS articolo	1/2"	DESCRIZIONE
BGS 5270	3/8"	10 MM
BGS 5271	3/8"	11 MM
BGS 5272	3/8"	12 MM
BGS 5273	3/8"	13 MM
BGS 5274	3/8"	14 MM
BGS 5275	3/8"	15 MM
BGS 5276	3/8"	16 MM
BGS 5277	3/8"	17 MM
BGS 5278	3/8"	18 MM
BGS 5279	3/8"	19 MM
BGS 5269-8	1/2"	8 MM
BGS 5266-10	1/2"	10 MM
BGS 5266-11	1/2"	11 MM
BGS 5266-12	1/2"	12 MM
BGS 5266-13	1/2"	13 MM
BGS 5266-14	1/2"	14 MM
BGS 5266-15	1/2"	15 MM
BGS 5266-16	1/2"	16 MM
BGS 5266-17	1/2"	17 MM
BGS 5266-19	1/2"	19 MM
BGS 5269-21	1/2"	21 MM
BGS 5268-22	1/2"	22 MM
BGS 5268-24	1/2"	24 MM
BGS 5268-27	1/2"	27 MM
BGS 5268-32	1/2"	32 MM
BGS 5268-36	3/4"	36 MM
BGS 5268-41	3/4"	41 MM

CARATTERISTICHE

- finitura nera
- per l'allentamento di viti e dadi danneggiati
- idonee per uso con avvitatori
- l'innovativo profilo a spirale penetra nella testa di una vite o di un dado danneggiati, consentendo così di svitarli in sicurezza

BGS
articolo

BGS 5265

DESCRIZIONE

SET 10 PEZZI, ESTRATTORI, 10-19 MM, ATT. 3/8"

CARATTERISTICHE

- finitura nera
- per svitare viti, dadi, perni, prigionieri, ecc. danneggiati o arrugginiti
- anche per uso con avvitatori ad impulsivi
- l'innovativo profilo a spirale penetra nella testa di una vite o di un dado danneggiati, consentendo così di svitarli in sicurezza
- misure: 10-11-12-13-14-15-16-17-19 mm
- misure singole disponibili articoli BGS 5270-5279
- peso: 740 g

3/8" CRO MO PRO+

RICAMBI

BGS articolo	DESCRIZIONE
BGS 5270	ESTRATTORE, 10 MM
BGS 5271	ESTRATTORE, 11 MM
BGS 5272	ESTRATTORE, 12 MM
BGS 5273	ESTRATTORE, 13 MM
BGS 5274	ESTRATTORE, 14 MM
BGS 5275	ESTRATTORE, 15 MM
BGS 5276	ESTRATTORE, 16 MM
BGS 5277	ESTRATTORE, 17 MM
BGS 5278	ESTRATTORE, 18 MM
BGS 5279	ESTRATTORE, 19 MM

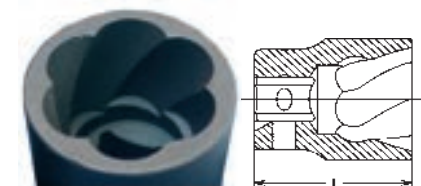

1/2" **PRO+** **CROMO**

BGS articolo	DESCRIZIONE
BGS 5266	SET 10 PEZZI, ESTRATTORI, 10-19 MM, ATT. 1/2"

- CARATTERISTICHE**
- finitura nera
 - per l'allentamento di viti e dadi danneggiati
 - idoneo per chiavi a impatto
 - l'innovativo profilo a spirale penetra nella testa di una vite o di un dado danneggiati, consentendo così di svitarli in sicurezza
 - misure: 10-11-12-13-14-15-16-17-19 mm
 - peso: 810 g

RICAMBI

BGS articolo	DESCRIZIONE
BGS 5266-10	ESTRATTORE, 10 MM
BGS 5266-11	ESTRATTORE, 11 MM
BGS 5266-12	ESTRATTORE, 12 MM
BGS 5266-13	ESTRATTORE, 13 MM
BGS 5266-14	ESTRATTORE, 14 MM
BGS 5266-15	ESTRATTORE, 15 MM
BGS 5266-16	ESTRATTORE, 16 MM
BGS 5266-17	ESTRATTORE, 17 MM
BGS 5266-19	ESTRATTORE, 19 MM

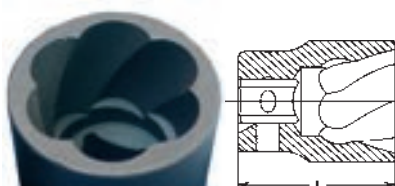

1/2" **PRO+** **CROMO**

BGS articolo	DESCRIZIONE
BGS 5269	SET 16 PEZZI, ESTRATTORI, 8-27 MM, ATT. 1/2"

- CARATTERISTICHE**
- finitura nera
 - per l'allentamento di viti e dadi danneggiati
 - idonee per uso con avvitatori
 - l'innovativo profilo a spirale penetra nella testa di una vite o di un dado danneggiati, consentendo così di svitarli in sicurezza
 - misure: 8-10-11-12-13-14-15-16-17-19-21-22-24-27 mm
 - peso: 1,3 kg

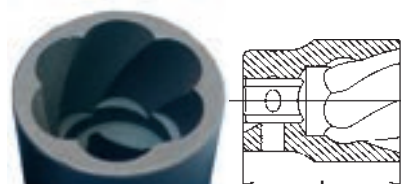

1/2" 3/4" **PRO+** **CROMO**

BGS articolo	DESCRIZIONE
BGS 5268	SET 6 PEZZI, ESTRATTORI, 22-41 MM, ATT. 1/2" - 3/4"

- CARATTERISTICHE**
- finitura nera
 - per l'allentamento di viti e dadi danneggiati
 - idonee per avvitatori
 - l'innovativo profilo a spirale penetra nella testa di una vite o di un dado danneggiati, consentendo così di svitarli in sicurezza
 - misure:
 - attacco 1/2": 22-24-27-32 mm
 - attacco 3/4": 36-41 mm
 - disponibili tutti i ricambi
 - peso: 1,6 kg

RICAMBI

BGS articolo	DESCRIZIONE
BGS 5268-22	ESTR. ATT. 1/2", 22 MM
BGS 5268-24	ESTR. ATT. 1/2", 24 MM
BGS 5268-27	ESTR. ATT. 1/2", 27 MM
BGS 5268-32	ESTR. ATT. 1/2", 32 MM
BGS 5268-36	ESTR. ATT. 3/4", 36 MM
BGS 5268-41	ESTR. ATT. 3/4", 41 MM



1/2" PRO+ CROMO

BGS articolo	DESCRIZIONE
BGS 5262	SET 5 PEZZI, ESTRATTORI LUNGH. 150 MM, ATT. 1/2"

CARATTERISTICHE	
• finitura nera	
• per l'allentamento di viti e dadi danneggiati	
• idonee per avvitatori	
• l'innovativo profilo a spirale penetra nella testa di una vite o di un dado danneggiati, consentendo così di sviarli in sicurezza	
• misure: 17 - 19 - 21 - 22 mm, con cacciaspine	
• peso: 1,7 kg	



1/2" PRO+ CROMO

BGS articolo	DESCRIZIONE
BGS 5264	SET 3 PEZZI, ESTRATTORI TIPO LUNGO, 17-19-21 MM + CACCIASPINE, ATT. 1/2"

CARATTERISTICHE	
• finitura nera	
• per l'allentamento di viti e dadi danneggiati	
• idonee per avvitatori	
• l'innovativo profilo a spirale penetra nella testa di una vite o di un dado danneggiati, consentendo così di sviarli in sicurezza	
• lunghezza: 150 mm	
• peso: 1,3 kg	
• BGS 5264 composto da:	
- estrattori: 17 - 19 - 21	
- cacciaspine	

RICAMBI	
BGS articolo	DESCRIZIONE
BGS 5264-17	ESTRATTORE 17 MM
BGS 5264-19	ESTRATTORE 19 MM
BGS 5264-21	ESTRATTORE 21 MM
BGS 5264-22	ESTRATTORE 22 MM
BGS 5264-TB	CACCIASPINE



BGS 7467-17



BGS 7467-19



BGS 7467-21



PRO+ CROMO 1/2"

BGS articolo	DESCRIZIONE
BGS 7467	SET 4 PEZZI, BUSSOLE/ESTRATTORI DOPPI, 17 - 19 - 21 MM, ATT. 1/2"

CARATTERISTICHE	
• bussole / estrattori a doppio lato, lunghi	
• doppio lato:	
- bussola esagonale	
- estrattore dadi e le teste delle viti bloccate	
• l'innovativo profilo a spirale penetra nella testa di una vite o di un dado danneggiati, consentendo così di sviarli in sicurezza	
• comprende:	
- bussola / estrattore 17 mm, att. 1/2"	
- bussola / estrattore 19 mm, att. 1/2"	
- bussola / estrattore 21 mm, att. 1/2"	
- prolunga att. 1/2"	
- cacciaspine	
• peso: 960 g	

RICAMBI	
BGS articolo	DESCRIZIONE
BGS 7467-17	17 MM
BGS 7467-19	19 MM
BGS 7467-21	21 MM



3/8" BGS Do 7 Pin

BGS articolo	DESCRIZIONE
BGS 20210	SET 10 PEZZI, ESTRATTORI 9-19 MM, ATT. 3/8"

CARATTERISTICHE	
• per l'allentamento di viti e dadi danneggiati	
• l'innovativo profilo a spirale penetra nella testa di una vite o di un dado danneggiati, consentendo così di sviarli in sicurezza	
• misure: 9-10-11-12-13-14-15-16-17-19 mm	
• attacco quadro femmina 3/8" e esagonale esterno	
• in custodia di alluminio	
• peso: 630 g	



1/2" PRO+ CROMO

BGS articolo	DESCRIZIONE
BGS 5261	SET 5 PEZZI ESTRATTORI A SPIRALE, 8-16 MM, ATT. 1/2"

CARATTERISTICHE	
• 8-10-12-14-16 mm	
• finitura nera	
• per l'allentamento di viti e dadi danneggiati	
• idonee per avvitatori	
• l'innovativo profilo a spirale penetra nella testa di una vite o di un dado danneggiati, consentendo così di sviarli in sicurezza	
• peso: 870 g	



BGS articolo	DESCRIZIONE
BGS 8383	SET 11 PEZZI, ESTRATTORI METRICI, ATT. 3/8"

CARATTERISTICHE	
<ul style="list-style-type: none"> bussole speciali per allentare le viti e dadi a testa esagonale rovinate dimensioni: 8 - 9 - 10 - 11 - 12 - 13 - 14 - 15 - 16 - 17 - 19 mm anche per serrare le viti attacco quadro femmina: 3/8" (10 mm) finitura cromata satinata materiale: acciaio al cromo molibdeno peso: 1,0 kg 	



BGS articolo	DESCRIZIONE
BGS 8378	SET 17 PEZZI, ESTRATTORI PER VITI, DADI E PRIGIONIERI, ATT. 3/8"

CARATTERISTICHE	
<ul style="list-style-type: none"> per dadi, viti rovinati e prigionieri contenuto: <ul style="list-style-type: none"> - 5 estrattori sinistri per viti danneggiate - 4 estrattori per prigionieri 6 - 8 - 10 - 12 mm - 8 bussole speciali "Zig Zag" per dadi esagonali rovinati 9-10-11-12-13-14-16-19 mm attacco 3/8" tutti i componenti realizzati in acciaio al cromo molibdeno peso: 1,6 kg 	



FERMEC articolo	DESCRIZIONE
8932	SET 21 PEZZI, INSERTI SPECIALI PER BULLONI DI SICUREZZA PER BMW, ATT. 1/2"

CARATTERISTICHE	
<ul style="list-style-type: none"> con inserti lunghezza 25 mm e attacco esagonale 17 mm comprende: <ul style="list-style-type: none"> 20 inserti speciali con attacco esagonale 17 mm: <ul style="list-style-type: none"> - 13 punte con foro; 15 punte con foro; 16 punte con foro; - 16 punte; 14 punte; 15 punte - 17 punte con foro; 16 punte con foro; 19 punte con foro - 10 punte; 11 punte; 12 punte; - 20 punte con foro; 21 punte con foro; 22 punte con foro; 23 punte con foro - 13 punte; 7 punte; 9 punte; 8 punte bussola esagonale 17 mm rivestita, attacco 1/2" in cassetta 	



FERMEC articolo	DESCRIZIONE
BMW 20	SET 20 PEZZI, INSERTI SPECIALI PER BULLONI DI SICUREZZA PER BMW

CARATTERISTICHE	
<ul style="list-style-type: none"> comprende 20 inserti speciali con attacco esagonale 17 mm, lunghezza 37 mm 	



FERMEC articolo	DESCRIZIONE
8933	SET 23 PEZZI, INSERTI SPECIALI PER BULLONI DI SICUREZZA PER VAG, ATT. 1/2"

CARATTERISTICHE	
<ul style="list-style-type: none"> con inserti lunghezza 25 mm e attacco esagonale 17 mm comprende: <ul style="list-style-type: none"> 22 inserti speciali con attacco esagonale 17 mm: <ul style="list-style-type: none"> - 6 punte con foro; 7 punte con foro; 8 punte con foro; 9 punte con foro; 10 punte con foro; 11 punte con foro; 12 punte con foro; 13 punte con foro; 14 punte con foro; 15 punte con foro; 16 punte con foro; 17 punte con foro; - 10 punte; 11 punte; 13 punte; 14 punte; 15 punte; 16 punte; 17 punte; 19 punte; 20 punte; 21 punte bussola esagonale 17 mm rivestita, attacco 1/2" in cassetta 	

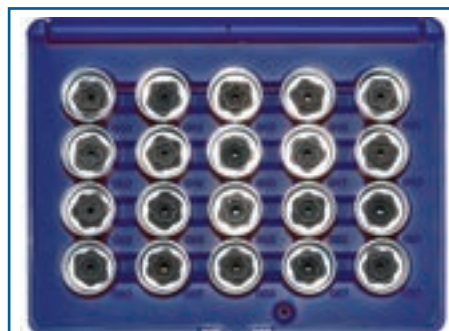

FERMEC articolo	DESCRIZIONE
VW 20	SET 20 PEZZI, INSERTI SPECIALI PER BULLONI DI SICUREZZA PER VW

CARATTERISTICHE	
<ul style="list-style-type: none"> comprende 20 inserti speciali con attacco esagonale 17 mm, lunghezza 37 mm 	

novità





BGS articolo	DESCRIZIONE
BGS 8962	1/6 MODULO PER CARRELLO, SET 20 PEZZI, INSERTI SPECIALI PER BULLONI DI SICUREZZA, PER BMW

CARATTERISTICHE

- per bulloni di sicurezza su cerchi BMW
- modulo in schiuma ad alta resistenza
- attacco: esagonale 17 mm
- comprende:
 - 20 inserti per bulloni di sicurezza: #41 - #42 - #43 - #44 - #45 - #46 - #47 - #48 - #49 - #50 - #51 - #52 - #53 - #54 - #55 - #56 - #57 - #58 - #59 - #60
- peso: 2,2 kg

novità





BGS articolo	DESCRIZIONE
BGS 74388	1/6 MODULO PER CARRELLO: 5 PEZZI BUSSOLE PER BULLONI DI SICUREZZA PER TESLA

CARATTERISTICHE

- per il montaggio e lo smontaggio dei bloccaggi delle ruote e dei dadi dei bloccaggi delle ruote
- copre quasi tutti i profili di chiusura dei cerchi disponibili per i modelli Tesla
- per bulloni di sicurezza per cerchi #A, #B, #C, #D, #E
- modulo in foam
- compatibile con i carrelli da officina BGS
- per i veicoli: Tesla Model 3, S, X
- attacco: esagonale 21 mm
- peso: 640 g

novità









BGS articolo	DESCRIZIONE
BGS 74421	1/6 MODULO PER CARRELLO, SET 11 PEZZI, INSERTI SPECIALI PER BULLONI DI SICUREZZA, PER BMW

CARATTERISTICHE

- per bulloni di sicurezza su cerchi BMW
- modulo in schiuma ad alta resistenza
- attacco: esagonale 17 mm
- comprende:
 - 10 inserti per bulloni di sicurezza: #30/13PT, #31/15PT, #32/16PT, #33/17PT, #34/18PT, #35/19PT, #36/20PT, #37/21PT, #38/22PT, #40/23PT
 - 1 bussola ricoperta, att. 1/2", | 17 mm (BGS 7201)
- peso: 800 g

BGS articolo	DESCRIZIONE
BGS 6659	1/6 MODULO PER CARRELLO: SET 20 PEZZI, INSERTI SPECIALI PER BULLONI DI SICUREZZA, PER VAG

CARATTERISTICHE

- comprende 20 inserti speciali con attacco esagonale 17 mm
- per uso come OEM T20213
- in modulo per carrello
- peso: 2,2 Kg
- dimensioni:** (lunghezza x profondità x altezza) **189 x 136 x 32 mm**







BGS articolo	DESCRIZIONE
BGS 9099	1/6 MODULO PER CARRELLO, SET 20 PEZZI, INSERTI SPECIALI PER BULLONI DI SICUREZZA PER PORSCHE & VW TOUAREG

CARATTERISTICHE

- comprende 20 inserti speciali con attacco esagonale 19 mm
- nr.50x14-lati. - nr.51x15-lati. - nr.52x16-lati. - nr.53x17-lati. - nr.53x18-lati. - nr.55x19-lati. - nr.56x20-lati. - nr.57x21-lati. - nr.58x22-lati. - nr.59x23-lati. - nr.60x14-lati. - nr.61x15-lati. - nr.62x16-lati. - nr.63x17-lati. - nr.64x18-lati. - nr.65x19-lati. - nr.66x20-lati. - nr.67x21-lati. - nr.68x22-lati. - nr.69x23-lati.
- peso: 2,0 kg
- dimensioni:** (lunghezza x profondità x altezza) **189 x 136 x 32 mm**





BGS articolo	DESCRIZIONE
BGS 9553	1/6 MODULO PER CARRELLO, SET 10 PEZZI, INSERTI SPECIALI PER BULLONI DI SICUREZZA, PER LAND ROVER

CARATTERISTICHE

- comprende 10 inserti speciali con attacco esagonale 17 mm, lunghezza 37 mm
- in modulo per carrello
- peso: 1,7 kg
- dimensioni:** (lunghezza x profondità x altezza) **189 x 136 x 32 mm**

novità





BGS articolo	DESCRIZIONE
BGS 74556	1/6 MODULO PER CARRELLO, SET 17 PEZZI, INSERTI SPECIALI PER BULLONI DI SICUREZZA, PER LAND ROVER

CARATTERISTICHE

- comprende 17 inserti speciali con attacco esagonale 17 mm
- peso 2,5 kg
- dimensioni: (lunghezza x profondità x altezza) 189 x 136 x 32 mm
- peso: 2,4 kg





BGS articolo	DESCRIZIONE
BGS 9557	1/6 MODULO PER CARRELLO, SET 20 PEZZI, INSERTI SPECIALI PER BULLONI DI SICUREZZA, PER OPEL/VAUXHALL (VERSIONE B)

CARATTERISTICHE

- comprende 20 inserti speciali con attacco esagonale 17 mm
- peso: 2,6 kg
- **dimensioni:** (lunghezza x profondità x altezza) **189 x 136 x 32 mm**





BGS articolo	DESCRIZIONE
BGS 9653	1/6 MODULO PER CARRELLO, SET 20 PEZZI, INSERTI SPECIALI PER BULLONI DI SICUREZZA, PER VOLVO

CARATTERISTICHE

- in modulo per carrello
- comprende 20 inserti speciali con attacco esagonale 19 mm, lunghezza 42,5 mm
- peso: 2,6 kg
- **dimensioni:** (lunghezza x profondità x altezza) **189 x 136 x 32 mm**







BGS articolo	DESCRIZIONE
BGS 9499	1/6 MODULO PER CARRELLO, SET 20 PEZZI, INSERTI SPECIALI PER BULLONI DI SICUREZZA PER AUDI

CARATTERISTICHE

- comprende 20 inserti speciali con attacco esagonale 17 mm
- per uso come OEM T40073
- peso: 2,2 kg
- **dimensioni:** (lunghezza x profondità x altezza) **189 x 136 x 32 mm**







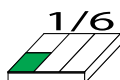

BGS articolo	DESCRIZIONE
BGS 9559	1/6 MODULO PER CARRELLO, SET 7 PEZZI, INSERTI SPECIALI PER BULLONI DI SICUREZZA, PER OPEL/VAUXHALL (VERSIONE D)

CARATTERISTICHE

- comprende 7 inserti speciali con attacco esagonale 17 mm
- peso: 970 g
- **dimensioni:** (lunghezza x profondità x altezza) **189 x 136 x 32 mm**

BGS articolo	DESCRIZIONE
BGS 9469	1/6 MODULO PER CARRELLO, SET 35 PEZZI, INSERTI SPECIALI PER BULLONI DI SICUREZZA, PER MERCEDES

CARATTERISTICHE

- comprende: 32 inserti speciali con attacco esagonale, bussola portainseri speciali, caccia-spine, gancio per rimozione copri-dadi
- peso: 1,1 kg
- **dimensioni:** (lunghezza x profondità x altezza) **189 x 136 x 32 mm**

TOP

VIDEO
TUTORIAL

PER
BULLONI DI
SICUREZZA
CON
ANELLO
GIREVOLE
BMW,
MINI & VW



anello
girevole
corpo
bullone



BMW & MINI



PULLER



(1)
AVVITARE SALDAMENTE
L'ESTRATTORE
REGOLABILE AL BULLONE



(2)
UNIRE IL MARTELLO A
MASSA BATTENTE ED
APPLICARE FORZA FINO
ALLA ROTTURA DEL
BULLONE



(3)
IL BULLONE DI
SICUREZZA SI SEPARA IN
TRE PARTI



(4)
COLLOCARE
L'ESTRATTORE PER
BULLONI PER SVITARE
LA PARTE DI BULLONE
ANCORA AVVITATA



(5)
RIMUOVERE IL BULLONE
DALL'ESTRATTORE
CON L'AIUTO DEL
CACCIASPINE

PULLER-1



PULLER-2



PULLER-3



PULLER-4



#FERMEC
articolo
PULLER

DESCRIZIONE

SET 4 PEZZI, ESTRATTORE PER BULLONI DI SICUREZZA BMW E MINI

CARATTERISTICHE

- per uso con bulloni di sicurezza con anello girevole BMW e MINI
- comprende:
 - martello a massa battente 1,5 kg
 - estrattore regolabile
 - estrattore per bulloni
 - cacciaspine
- in cassetta in plastica

RICAMBI

#FERMEC
articolo

DESCRIZIONE

PULLER-1

ESTRATTORE CON GRIFFE

PULLER-2

PERNO CON IMPRONTA MULTIRIGHE

PULLER-3

CACCIASPINE

PULLER-4

MARTELLO A MASSA BATTENTE



PDF ISTRUZIONI

VIDEO TUTORIAL



YouTube

NON SERVE PIU' FORARE I BULLONI

RIMOZIONE SICURA SENZA DANNI AI CERCHI

FM 84100-1



FM 84100-2



FM 84100-3



FM 84100-4



FM 84100-5



FM 84100-6



FM 84100-7



FEIMEC articolo	DESCRIZIONE
FM 84100	SET ESTRATTORE BULLONI DI SICUREZZA

CARATTERISTICHE

- per rimuovere i bulloni di sicurezza
- comprende:
 - due punzoni di differenti misure
 - cacciavite a percussione
 - cacciaspine
 - tre lame modellate bilaterali

RICAMBI

FEIMEC articolo	DESCRIZIONE
FM 84100-1	1 LAMA MODELLATA BILATERALE DI RICAMBIO
FM 84100-2	1 CANOTTO DI GUIDA CORTO
FM 84100-3	1 LAMA ESTRAZIONE NERA PICCOLA
FM 84100-4	1 LAMA ESTRAZIONE NERA GRANDE
FM 84100-5	1 PUNZONE DI CENTRAGGIO PICCOLO
FM 84100-6	1 PUNZONE DI CENTRAGGIO GRANDE
FM 84100-7	1 MOLLA



CASSETTE METALLICHE PORTA-BUSSOLE

FEARMEC articolo	lunghezza (mm)	larghezza (mm)	altezza (mm)	
CASS-2510	240	100	60	1
CASS-2810	280	130	75	1
CASS-3009	300	90	45	1
CASS-3112	310	120	80	1
CASS-3211	320	120	50	1
CASS-4220	420	200	140	1
CASS-6213	610	130	80	1

NOTE

- a richiesta assortimenti di bussole a macchina in cassetta metallica



PRO+

GUIDE PORTA BUSSOLE CON CLIP

BGS articolo		Numero Clip
BGS 2316	1/4"	7
BGS 2317	3/8"	7
BGS 2318	1/2"	7
BGS 2120	1/4"	15
BGS 2330	3/8"	15
BGS 2540	1/2"	15
BGS 3460	3/4"	12

CARATTERISTICHE

- cromato satinato



GUIDE PORTA BUSSOLE PER MOLLE IN ACCIAIO DA 1/4" - 3/8" - 1/2" - 3/4"

Koken articolo	L mm	
R 158	158	1
R 251	251	1
R 300	300	1
R 400	400	1



MOLLE IN ACCIAIO PER GUIDE

Koken articolo		
C 14	1/4"	1
C 38	3/8"	1
C 12	1/2"	1
C 34	3/4"	1

BGS 74549



BGS 74550



BGS 74551



1/4" 3/8" 1/2"



PRO+

GUIDE MAGNETICHE PORTABUSSOLE, CON CLIP

BGS articolo	DESCRIZIONE	PESO GR.
BGS 74549	1/4"	260 GR.
BGS 74550	3/8"	270 GR.
BGS 74551	1/2"	300 GR.

CARATTERISTICHE

- adatto per bussole attacco:
 - BGS 74549: 1/4"
 - BGS 74550: 3/8"
 - BGS 74551: 1/2"
- con 12 clip
- con supporto in plastica
- base del supporto magnetica: garantisce la tenuta su tutte le superfici ferrose, su carrelli da officina, combinazioni di sistemi di stoccaggio, macchine, piattaforme di sollevamento e cassette in metallo
- base con fori a ciascuna estremità per l'installazione a parete
- materiale: alluminio / plastica
- dimensioni (larghezza - altezza - lunghezza):
 - BGS 74549, attacco 1/4": 28 x 20 x 420 mm
 - BGS 74550, attacco 3/8": 28 x 22 x 420 mm
 - BGS 74551, attacco 1/2": 28 x 25 x 420 mm





JAPAN



GUIDE MAGNETICHE PORTA BUSSOLE CON CLIP IDEALI PER USO SU PONTI SOLLEVATORI



Koken articolo		Nr. Clip	L mm	
RSAL 200-1/4X12	1/4"	12	200	1
RSAL 200-3/8X8	3/8"	8	200	1
RSAL 300-3/8X12	3/8"	12	300	1
RSAL 300-1/2X10	1/2"	10	300	1



**GUIDE PORTA BUSSOLE
MAGNETICHE PER MOLLE
IN PLASTICA**

Koken
articolo L mm

RSAL-200	200	1
RSAL-300	300	1

JAPAN



MOLLE IN PLASTICA PER GUIDE

Koken
articolo

CLIP-1/4	1/4"	1
CLIP-3/8	3/8"	1
CLIP-1/2	1/2"	1

JAPAN

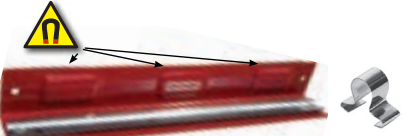

**GUIDA MAGNETICA PER MOLLE PORTA
BUSSOLE DA 1/4" - 3/8" - 1/2" - 3/4"**

FERMEC
articolo L mm

MAG 300	300	1
---------	-----	---



BARRA PORTA BUSSOLE MAGNETICA,

BGS
articolo

BCS 3011-1	1/4"	Numero vani
BCS 3011-2	3/8"	10
BCS 3011-3	1/2"	12

JAPAN **PRO+**

CARATTERISTICHE

- le bussole sono trattenute grazie ad una banda magnetica

BGS HANGER-1 1/4"

BGS HANGER-2 3/8"

BGS HANGER-3 1/2"

BGS HANGER-4 3/4"

BGS HANGER-5 1"



CLIP X ATTACCO QUADRO FEMMINA

BGS
articolo

BGS HANGER-1	1/4"
BGS HANGER-2	3/8"
BGS HANGER-3	1/2"
BGS HANGER-4	3/4"
BGS HANGER-5	1"

CARATTERISTICHE

- clip in plastica con quadro maschio
- ad esempio per esposizione bussole

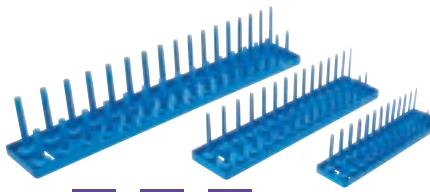

BGS
articolo

BGS 67158	DESCRIZIONE
	SET 3 PEZZI PORTA BUSSOLE

1/4" 3/8" 1/2" PRO+

CARATTERISTICHE

- con occhio per appenderle o per il montaggio a parete
- adatto per bussole corte e lunghe
- materiale: plastica
- comprende:
 - 1 supporto per 28 bussole attacco 1/4"
 - 1 supporto per 30 bussole attacco 3/8"
 - 1 supporto per 34 bussole attacco 1/2"
- peso: 630 g



BGS
articolo

BGS 6871	DESCRIZIONE
	SET GUIDE PER BUSSOLE, CON 80 CLIP, PER BUSSOLE 1/4", 3/8" E 1/2"

1/4" 3/8" 1/2" PRO+

CARATTERISTICHE

- ideale per lo stoccaggio delle bussole
- comprende:
 - 26 clip con sfera: 1/4"
 - 30 clip con sfera: 3/8"
 - 24 clip con sfera: 1/2"
 - 4 guide
 - piastra di fissaggio
- peso: 1,0 kg



novità

BGS
articolo

BGS 74484	DESCRIZIONE
	PIASTRA MAGNETICA, CON IMPUGNATURA, PER 36 BUSSOLE ATTACCO 1/4", 3/8" E 1/2"

1/4" 3/8" 1/2" PRO+

CARATTERISTICHE

- pratico supporto per bussole
- 12 clip magnetiche rotondi per ogni misura
- le clip magnetiche garantiscono una tenuta sicura la facilità di rimozione
- potente superficie magnetica della piastra
- per il fissaggio temporaneo a superfici metalliche, scaffali o carrelli da officina
- con impugnatura in metallo per appendere o trasportare
- portata massima: 5 kg
- larghezza: 155 mm
- altezza: 6 mm
- lunghezza: 335 mm
- peso: 1,4 kg



CHIAVI A BUSSOLA A MANO BOCCA ESAGONALE

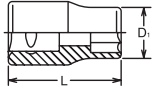

Koken articolo	mm	D ₁ mm	L mm	
2400M-3	3	5.5	22	1
2400M-3.5	3.5	6.1	22	1
2400M-4	4	6.7	22	1
2400M-4.5	4.5	7.3	22	1
2400M-5	5	8	22	1
2400M-5.5	5.5	8.5	22	1
2400M-6	6	9.2	22	1
2400M-7	7	10.3	22	1
2400M-8	8	11.2	22	1
2400M-9	9	13	22	1
2400M-10	10	14.3	22	1
2400M-11	11	15.5	22	1
2400M-12	12	16.8	22	1
2400M-13	13	18	22	1
2400M-14	14	19.3	24	1

POLLICI



CHIAVI A BUSSOLA A MANO BOCCA ESAGONALE

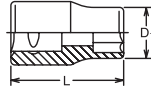

Koken articolo	pollici	D ₁ mm	L mm	
2400A-1/8	1/8"	5.2	22	1
2400A-5/32	5/32"	6.7	22	1
2400A-3/16	3/16"	7.7	22	1
2400A-7/32	7/32"	8.8	22	1
2400A-1/4	1/4"	9.6	22	1
2400A-9/32	9/32"	10.2	22	1
2400A-5/16	5/16"	11.3	22	1
2400A-11/32	11/32"	13	22	1
2400A-3/8	3/8"	14.3	22	1
2400A-7/16	7/16"	16	22	1
2400A-1/2	1/2"	18	22	1
2400A-9/16	9/16"	19.3	24	1

POLLICI



CHIAVI A BUSSOLA A MANO BOCCA POLIGONALE

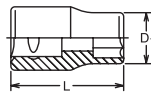

Koken articolo	pollici	D ₁ mm	L mm	
2405A-1/8	1/8"	5.2	22	1
2405A-5/32	5/32"	6.7	22	1
2405A-3/16	3/16"	7.7	22	1
2405A-7/32	7/32"	8.8	22	1
2405A-1/4	1/4"	9.6	22	1
2405A-9/32	9/32"	10.2	22	1
2405A-5/16	5/16"	11.3	22	1
2405A-11/32	11/32"	13	22	1
2405A-3/8	3/8"	14.3	22	1
2405A-7/16	7/16"	16	22	1
2405A-1/2	1/2"	18	22	1
2405A-9/16	9/16"	19.3	24	1



CHIAVI A BUSSOLA A MANO BOCCA SURFACE DRIVE

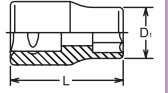

Koken articolo	mm	D ₁ mm	L mm	
2410M-4	4	6.7	22	1
2410M-4.5	4.5	7.3	22	1
2410M-5	5	8	22	1
2410M-5.5	5.5	8.5	22	1
2410M-6	6	9.2	22	1
2410M-7	7	10.3	22	1
2410M-8	8	11.2	22	1
2410M-9	9	13	22	1
2410M-10	10	14.3	22	1
2410M-11	11	15.5	22	1
2410M-12	12	16.8	22	1
2410M-13	13	18	22	1
2410M-14	14	19.3	24	1

BUSSOLE SURFACE DRIVE

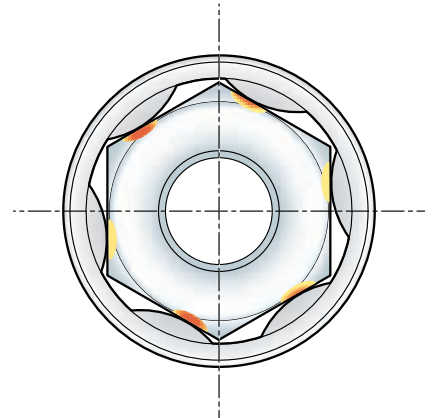

CHIAVI A BUSSOLA A MANO BOCCA POLIGONALE

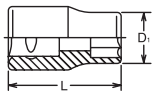

Koken articolo	mm	D ₁ mm	L mm	
2405M-3	3	5.5	22	1
2405M-3.5	3.5	6.1	22	1
2405M-4	4	6.7	22	1
2405M-4.5	4.5	7.3	22	1
2405M-5	5	8	22	1
2405M-5.5	5.5	8.5	22	1
2405M-6	6	9.2	22	1
2405M-7	7	10.3	22	1
2405M-8	8	11.2	22	1
2405M-9	9	13	22	1
2405M-10	10	14.3	22	1
2405M-11	11	15.5	22	1
2405M-12	12	16.8	22	1
2405M-13	13	18	22	1
2405M-14	14	19.3	24	1



CHIAVI A BUSSOLA A MANO BOCCA OTTAGONALE

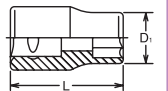

Koken articolo	mm	D ₁ mm	L mm	
2415M-5.5	5.5	10.3	22	1
2415M-6	6	11	22	1
2415M-7	7	12.5	22	1
2415M-8	8	14.3	22	1
2415M-10	10	17.4	22	1

POLLICI

2415A-1/4	1/4"	11	22	1
2415A-5/16	5/16"	14.3	22	1
2415A-3/8	3/8"	17.4	22	1





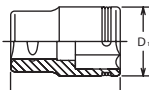

**NUT GRIP®
BLOCCADADI**

CHIAVI A BUSSOLA A
MANO BOCCA NUT GRIP®





Koken articolo		D ₁ mm	L mm		
2450MS-5	novità	5	9.2	17	1
2450MS-5.5	novità	5.5	9.8	17	1
2450MS-6	novità	6	10.2	17	1
2450MS-7		7	11.5	18	1
2450MS-8		8	12.3	18	1
2450MS-9	novità	9	13.3	19	1
2450MS-10		10	14.3	19	1
2450MS-11	novità	11	15.8	20	1
2450MS-12		12	17.4	20	1
2450MS-13		13	18	20	1
2450MS-14		14	19.9	22	1
2450AS-1/4	novità	1/4"	10.7	17	1
2450AS-5/16	novità	5/16"	12.3	18	1
2450AS-3/8	novità	3/8"	14.3	19	1
2450MS-7/16	novità	7/16"	16	20	1
2450AS-1/2	novità	1/2"	18	21	1
2450AS-9/16	novità	9/16"	20	22	1

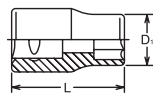

TORX®

CHIAVI A BUSSOLA A
MANO BOCCA TORX®



Koken articolo		D ₁ mm	L mm	
2425-E 4	E 4	11.2	22	1
2425-E 5	E 5	11.2	22	1
2425-E 6	E 6	11.2	22	1
2425-E 7	E 7	11.2	22	1
2425-E 8	E 8	11.2	22	1
2425-E 10	E10	12	22	1
2425-E 11	E11	12.9	22	1
2425-E 12	E12	14.3	23	1



TORX®

SERIE 6 PZ. CHIAVI A BUSSOLA
MISURE: E4, E5, E6, E7, E8, E10
BOCCA TORX

Koken articolo		L mm	
RS 2425/6		22	1







TORX®

SERIE 14 PZ. CHIAVI A BUSSOLA
BOCCA TORX®

Koken articolo		
RSX 425/14		1

CONTENUTO

 1/4"	2425	E4, E5, E6, E7, E8
 3/8"	3425	E10, E11, E12, E14
 1/2"	4425	E16, E18, E20, E22, E24



TORX®	S mm	S mm	
E 4	3.70	E 16	14.60
E 5	4.60	E 18	16.50
E 6	5.60	E 20	18.30
E 7	6.10	E 22	20.10
E 8	7.40	E 24	22.00
E 10	9.30	E 26	23.70
E 11	9.90	E 28	25.50
E 12	11.00	E 30	27.30
E 14	12.80	E 32	29.00

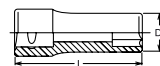

ESAGONO

CHIAVI A BUSSOLA A
MANO BOCCA ESAGONALE
SEMI LUNGHE







Koken articolo		D ₁ mm	L mm	
2300X-4	4	6.7	32	1
2300X-5	5	8	32	1
2300X-5.5	5.5	8.5	32	1
2300X-6	6	9.2	32	1
2300X-7	7	10.5	32	1
2300X-8	8	11.8	32	1
2300X-9	9	13	32	1
2300X-10	10	14.3	32	1
2300X-11	11	15.5	32	1
2300X-12	12	16.8	32	1
2300X-13	13	18	32	1
2300X-14	14	19.3	32	1



SERIE 12 PZ. CHIAVI A BUSSOLA
MISURE: 4, 5, 5.5, 6, 7, 8, 9, 10, 11, 12,
13, 14 MM

DISPONIBILI CON BOCCA:
ESAGONALE/POLIGONALE/SURFACE DRIVE





Koken articolo		L mm	
RS 2400M/12		22	1
RS 2405M/12		22	1
RS 2410M/12		22	1

POLLICI



SERIE 9 PZ. CHIAVI A BUSSOLA
MISURE: 3/16", 7/32", 1/4", 9/32", 5/16",
11/32", 3/8", 7/16", 1/2"

DISPONIBILI CON BOCCA:
ESAGONALE/POLIGONALE

Koken articolo		L mm	
RS 2400A/9		22	1
RS 2405A/9		22	1





ESAGONO

CHIAVI A BUSSOLA A MANO BOCCA ESAGONALE

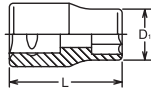

Koken articolo	mm	D ₁ mm	L mm	
2300M-3	3	5.4	50	1
2300M-4	4	6.8	50	1
2300M-4.5	4.5	7.1	50	1
2300M-5	5	8	50	1
2300M-5.5	5.5	8.3	50	1
2300M-6	6	9.3	50	1
2300M-7	7	10.9	50	1
2300M-8	8	11.6	50	1
2300M-9	9	13	50	1
2300M-10	10	14.3	50	1
2300M-11	11	16	50	1
2300M-12	12	17.4	50	1
2300M-13	13	18	50	1
2300M-14	14	19	50	1

POLLICI



ESAGONO

CHIAVI A BUSSOLA A MANO BOCCA ESAGONALE

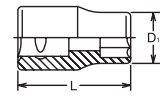

Koken articolo	pollici	D ₁ mm	L mm	
2300A-1/8	1/8"	5.4	50	1
2300A-5/32	5/32"	6.8	50	1
2300A-3/16	3/16"	8	50	1
2300A-7/32	7/32"	8.3	50	1
2300A-1/4	1/4"	9.8	50	1
2300A-9/32	9/32"	10.9	50	1
2300A-5/16	5/16"	11.6	50	1
2300A-11/32	11/32"	13	50	1
2300A-3/8	3/8"	14.3	50	1
2300A-7/16	7/16"	16	50	1
2300A-1/2	1/2"	18	50	1
2300A-9/16	9/16"	19	50	1



SURFACE DRIVE

CHIAVI A BUSSOLA A MANO BOCCA SURFACE DRIVE

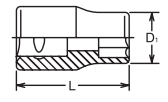

Koken articolo	mm	D ₁ mm	L mm	
2310M-3	3	5.4	50	1
2310M-4	4	6.8	50	1
2310M-4.5	4.5	7.1	50	1
2310M-5	5	8	50	1
2310M-5.5	5.5	8.3	50	1
2310M-6	6	9.3	50	1
2310M-7	7	10.9	50	1
2310M-8	8	11.6	50	1
2310M-9	9	13	50	1
2310M-10	10	14.3	50	1
2310M-11	11	16	50	1
2310M-12	12	17.4	50	1
2310M-13	13	18	50	1
2310M-14	14	19	50	1

BUSSOLE SURFACE DRIVE

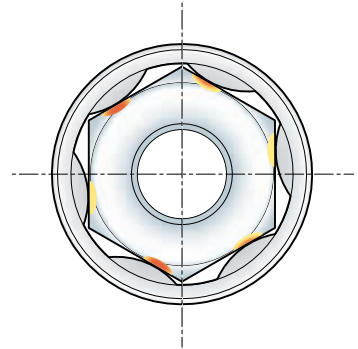

POLIGONALE

CHIAVI A BUSSOLA A MANO BOCCA POLIGONALE

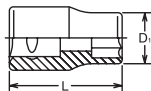

Koken articolo	mm	D ₁ mm	L mm	
2305M-3	3	5.4	50	1
2305M-4	4	6.8	50	1
2305M-4.5	4.5	7.1	50	1
2305M-5	5	8	50	1
2305M-5.5	5.5	8.3	50	1
2305M-6	6	9.3	50	1
2305M-7	7	10.9	50	1
2305M-8	8	11.6	50	1
2305M-9	9	13	50	1
2305M-10	10	14.3	50	1
2305M-11	11	16	50	1
2305M-12	12	17.4	50	1
2305M-13	13	18	50	1
2305M-14	14	19	50	1

POLLICI



POLIGONALE

CHIAVI A BUSSOLA A MANO BOCCA POLIGONALE

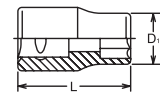

Koken articolo	pollici	D ₁ mm	L mm	
2305A-1/8	1/8"	5.4	50	1
2305A-5/32	5/32"	6.8	50	1
2305A-3/16	3/16"	8	50	1
2305A-7/32	7/32"	8.3	50	1
2305A-1/4	1/4"	9.8	50	1
2305A-9/32	9/32"	10.9	50	1
2305A-5/16	5/16"	11.6	50	1
2305A-11/32	11/32"	13	50	1
2305A-3/8	3/8"	14.3	50	1
2305A-7/16	7/16"	16	50	1
2305A-1/2	1/2"	18	50	1
2305A-9/16	9/16"	19	50	1





KOKEN 1/4"

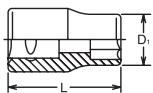

CHIAVI A BUSSOLA A MANO BOCCA TORX®







Koken articolo		D ₁ mm	L mm	
2325-E 4	E 4	5.4	50	1
2325-E 5	E 5	6.8	50	1
2325-E 6	E 6	8	50	1
2325-E 7	E 7	8.3	50	1
2325-E 8	E 8	9.8	50	1
2325-E 10	E10	11.6	50	1



SERIE 12 PZ. CHIAVI A BUSSOLA LUNGHE
MISURE: 4, 5, 5.5, 6, 7, 8, 9, 10, 11, 12, 13, 14 MM

DISPONIBILI CON BOCCA:
ESAGONALE/POLIGONALE

Koken articolo		L mm	
RS 2300M/12		50	1
RS 2305M/12		50	1

POLLICI



CHIAVI A BUSSOLA A MANO SNODATE BOCCA ESAGONALE

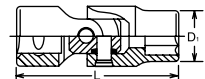





Koken articolo	pollici	D ₁ mm	L mm	
2440A-1/4	1/4"	9.8	33	1
2440A-5/16	5/16"	11.7	34	1
2440A-3/8	3/8"	13.7	35	1
2440A-7/16	7/16"	15.5	36	1
2440A-1/2	1/2"	18	37	1
2440A-9/16	9/16"	19.2	37	1

POLLICI



SERIE 9 PZ. CHIAVI A BUSSOLA LUNGHE
MISURE: 3/16", 7/32", 1/4", 9/32", 5/16"

11/32", 3/8", 7/16", 1/2"
DISPONIBILI CON BOCCA:
ESAGONALE/POLIGONALE

Koken articolo		L mm	
RS 2300A/9		50	1
RS 2305A/9		50	1



CHIAVI A BUSSOLA A MANO SNODATE BOCCA POLIGONALE

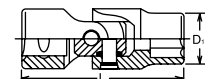



Koken articolo	mm	D ₁ mm	L mm	
2445M-4	4	6.7	31.5	1
2445M-5	5	8	32	1
2445M-6	6	9.2	33	1
2445M-7	7	10.5	33	1
2445M-8	8	11.7	34	1
2445M-9	9	13	34	1
2445M-10	10	14.2	35	1
2445M-11	11	15.5	36	1
2445M-12	12	16.7	37	1
2445M-13	13	18	37	1
2445M-14	14	19.2	37	1

POLLICI

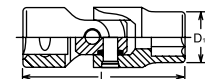

CHIAVI A BUSSOLA A MANO SNODATE BOCCA POLIGONALE



Koken articolo	pollici	D ₁ mm	L mm	
2445A-3/16	3/16"	8	32	1
2445A-1/4	1/4"	9.8	33	1
2445A-9/32	9/32"	10.5	33	1
2445A-5/16	5/16"	11.7	34	1
2445A-11/32	11/32"	13	34	1
2445A-3/8	3/8"	13.7	35	1
2445A-7/16	7/16"	15.5	36	1
2445A-1/2	1/2"	18	37	1
2445A-9/16	9/16"	19.2	37	1



CHIAVI A BUSSOLA A MANO BOCCA NUT GRIP®

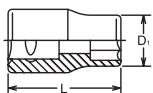

Koken articolo	mm	D ₁ mm	L mm	
2350M-8	8	12.3	50	1
2350M-10	10	14.3	50	1
2350M-12	12	16.8	50	1
2350M-13 <small>novità</small>	13	18	50	1
2350M-14	14	20	50	1



CHIAVI A BUSSOLA A MANO SNODATE BOCCA ESAGONALE

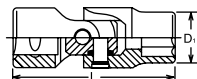

Koken articolo	mm	D ₁ mm	L mm	
2440M-4	4	6.7	31.5	1
2440M-5	5	8	32	1
2440M-6	6	9.2	33	1
2440M-7	7	10.5	33	1
2440M-8	8	11.7	34	1
2440M-9	9	13	34	1
2440M-10	10	14.2	35	1
2440M-11	11	15.5	36	1
2440M-12	12	16.7	37	1
2440M-13	13	18	37	1
2440M-14	14	19.2	37	1



CHIAVI A BUSSOLA A MANO SNODATE BOCCA TORX®

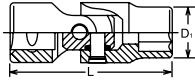

Koken articolo		D ₁ mm	L mm	
2440T-E 6	E 6	8,0	31,9	1
2440T-E 8	E 8	9,8	33,1	1
2440T-E 10	E10	11,7	33,6	1
2440T-E 12	E12	14,2	35,1	1



CHIAVI A BUSSOLA A CROCE PHILLIPS®

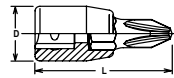

Koken articolo		D mm	L mm	
2000-28 (PH)-1	PH1	12	28	1
2000-28 (PH)-2	PH2	12	28	1
2000-28 (PH)-3	PH3	12	28	1
2000-28 (PH)-4	PH4	13,1	28	1



CHIAVI A BUSSOLA MASCHIO ESAGONALE

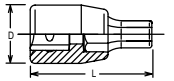

Koken articolo		D mm	L mm	
2010M-25-1.5	1.5	11.9	25	1
2010M-25-2	2	11.9	25	1
2010M-25-2.5	2.5	11.9	25	1
2010M-25-3	3	11.9	25	1
2010M-25-4	4	11.9	25	1
2010M-25-5	5	11.9	25	1
2010M-25-6	6	11.9	25	1
2010M-25-7	7	13.1	25	1
2010M-25-8	8	13.1	25	1
2010M-25-10	10	14.3	25	1
2010M-25-12	12	16.4	25	1
2010M-100-2	2	11.9	100	1
2010M-100-2.5	2.5	11.9	100	1
2010M-100-3	3	11.9	100	1
2010M-100-4	4	11.9	100	1
2010M-100-5	5	13.1	100	1
2010M-100-6	6	13.1	100	1
2010M-100-7	7	13.1	100	1
2010M-100-8	8	13.1	100	1
2010M-100-10	10	14.3	100	1
2010M-100-12	12	16.4	100	1



CHIAVI A BUSSOLA A MANO SNODATE BOCCA NUT GRIP®

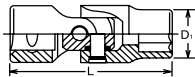

Koken articolo		D ₁ mm	L mm	
2441M-5 novità	5	9,2	31,5	1
2441M-5.5 novità	5.5	9,8	31,5	1
2441M-6	6	10,2	31,5	1
2441M-7	7	11,3	31,5	1
2441M-8	8	12,3	32	1
2441M-10	10	14,5	32,5	1
2441M-11 novità	11	15,5	33,5	1
2441M-12	12	16,8	34	1
2441M-13	13	18,0	35	1
2441M-14	14	20,0	35,5	1
2441M-15 novità	15	21	36	1



CHIAVI A BUSSOLA A CROCE POZIDRIV®

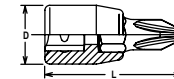

Koken articolo		D mm	L mm	
2000-28 (PZ)-1	PZ1	12	28	1
2000-28 (PZ)-2	PZ2	12	28	1
2000-28 (PZ)-3	PZ3	12	28	1



CHIAVI A BUSSOLA A TAGLIO

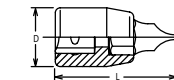

Koken articolo		D mm	L mm	
2005-25-3	0.5x 3	12	25	1
2005-25-4	0.8x 4	12	25	1
2005-25-5	1.0x 5.5	12	25	1
2005-25-6	1.2x 6.5	13.1	25	1
2005-25-8	1.2x 8	13.1	25	1
2005-25-9	1.6x 8	13.1	25	1
2005-25-10	1.6x 10	14.3	25	1





POLLICI

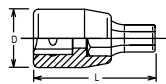

 **ESAGONO**

CHIAVI A BUSSOLA MASCHIO ESAGONALE





Koken articolo	 pollici	D mm	L mm	
2010A-25-1/8	1/8"	12	25	1
2010A-25-5/32	5/32"	12	25	1
2010A-25-3/16	3/16"	12	25	1
2010A-25-7/32	7/32"	12	25	1
2010A-25-1/4	1/4"	12	25	1
2010A-25-9/32	9/32"	13.1	25	1
2010A-25-5/16	5/16"	13.1	25	1
2010A-25-3/8	3/8"	14.3	25	1
2010A-25-7/16	7/16"	15.5	25	1
<hr/>				
2010A-100-1/8	<i>novità</i> 1/8"	12	100	1
2010A-100-5/32	<i>novità</i> 5/32"	12	100	1
2010A-100-3/16	<i>novità</i> 3/16"	12	100	1
2010A-100-7/32	<i>novità</i> 7/32"	12	100	1
2010A-100-1/4	<i>novità</i> 1/4"	12	100	1
2010A-100-9/32	<i>novità</i> 9/32"	13.1	100	1
2010A-100-5/16	<i>novità</i> 5/16"	13.1	100	1
2010A-100-3/8	<i>novità</i> 3/8"	14.3	100	1



 **ESAGONO**

CHIAVI A BUSSOLA MASCHIO ESAGONALE TESTA SFERICA



Koken articolo	 mm	D mm	L mm	
2011M-50-3	3	12	50	1
2011M-50-4	4	12	50	1
2011M-50-5	5	12	50	1
2011M-50-6	6	12	50	1





 **XZN**

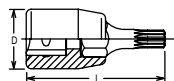

CHIAVI A BUSSOLA MASCHIO XZN



Koken articolo		D mm	L mm	
2020-28-M4	M 4	12	28	1
2020-28-M5	M 5	12	28	1
2020-28-M6	M 6	12	28	1
2020-28-M8	M 8	13.1	28	1
<hr/>				
2020-50-M4	M 4	12	50	1
2020-50-M5	M 5	12	50	1
2020-50-M6	M 6	12	50	1
2020-50-M8	M 8	13.1	50	1

	XZN		S mm	
	M	S	M	S
	M 4	3,60	M12	11,50
	M 5	4,80	M14	13,30
	M 6	6,10	M16	15,70
	M 8	7,30	M18	16,90
	M10	9,70		





 **TORX®**

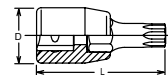

CHIAVI A BUSSOLA MASCHIO TORX®



Koken articolo		D mm	L mm	
2025-28-T8	TX 8	12	28	1
2025-28-T9	TX 9	12	28	1
2025-28-T10	TX 10	12	28	1
2025-28-T15	TX 15	12	28	1
2025-28-T20	TX 20	12	28	1
2025-28-T25	TX 25	12	28	1
2025-28-T27	TX 27	12	28	1
2025-28-T30	TX 30	12	28	1
2025-28-T40	TX 40	12	28	1
<hr/>				
2025-80-T10	TX 10	12	80	1
2025-80-T15	TX 15	12	80	1
2025-80-T20	TX 20	12	80	1
2025-80-T25	TX 25	12	80	1
2025-80-T27	TX 27	12	80	1
2025-80-T30	TX 30	12	80	1
2025-80-T40	TX 40	12	80	1

	TORX®		S mm	
	T	S	T	S
	T 6	1.70	T 40	6.70
	T 7	2.00	T 45	7.90
	T 8	2.30	T 50	8.90
	T 9	2.50	T 55	11.30
	T 10	2.70	T 60	13.30
	T 15	3.30	T 70	15.60
	T 20	3.90	T 80	17.60
	T 25	4.50	T 90	20.00
	T 27	5.00	T 100	22.20
	T 30	5.60		





KOKEN O 1/4"

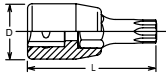

CHIAVI A BUSSOLA MASCHIO TORX® CON FORO





Koken articolo		D mm	L mm	
2025-28-T10H	TH 10	12	28	1
2025-28-T15H	TH 15	12	28	1
2025-28-T20H	TH 20	12	28	1
2025-28-T25H	TH 25	12	28	1
2025-28-T27H	TH 27	12	28	1
2025-28-T30H	TH 30	12	28	1
2025-28-T40H	TH 40	12	28	1



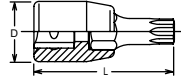

CHIAVI A BUSSOLA MASCHIO TORX PLUS® CON FORO



Koken articolo		D	L mm	
2025-28-8IPR	8 IPR	12	28	1
2025-28-9IPR	9 IPR	12	28	1
2025-28-10IPR	10 IPR	12	28	1
2025-28-15IPR	15 IPR	12	28	1
2025-28-20IPR	20 IPR	12	28	1
2025-28-25IPR	25 IPR	12	28	1
2025-28-27IPR	27 IPR	12	28	1
2025-28-30IPR	30 IPR	12	28	1
2025-28-40IPR	40 IPR	12	28	1





SERIE 7 PZ. CHIAVI A BUSSOLA MASCHIO ESAGONALE **ESAGONO**

Koken articolo		mm	L mm	
RS 2010M/7-L25		3, 4, 5, 6, 7, 8, 10	25	1

POLLICI





SERIE 8 PZ. CHIAVI A BUSSOLA MASCHIO ESAGONALE **ESAGONO**

Koken articolo		pollici	L mm	
RS 2010A/8-L25		1/8, 5/32, 3/16, 7/32, 1/4, 9/32, 5/16, 3/8	25	1

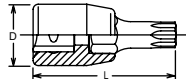

CHIAVI A BUSSOLA MASCHIO TORX PLUS®



Koken articolo		D mm	L mm	
2025-28-8IP	8IP	12	28	1
2025-28-9IP	9IP	12	28	1
2025-28-10IP	10IP	12	28	1
2025-28-15IP	15IP	12	28	1
2025-28-20IP	20IP	12	28	1
2025-28-25IP	25IP	12	28	1
2025-28-27IP	27IP	12	28	1
2025-28-30IP	30IP	12	28	1
2025-28-40IP	40IP	12	28	1



novità



SERIE 11 PZ. CHIAVI A BUSSOLA MASCHIO TORX PLUS® CON FORO



Koken articolo	
RSX 025/11-IPR	1

CONTENUTO

- 1/4" 2025-28 IPR 8 IPR, 10 IPR, 15 IPR, 20 IPR, 25 IPR, 27 IPR, 30 IPR
- 3/8" 3025-50 IPR 40 IPR, 45 IPR, 50 IPR, 55 IPR





SERIE 7 PZ. CHIAVI A BUSSOLA MASCHIO TORX® **TORX®**

Koken articolo		L mm	
RS 2025/7-L28	TX10, TX15, TX20, TX25, TX27, TX30, TX40	28	1





SERIE 7 PZ. CHIAVI A BUSSOLA MASCHIO TORX® CON FORO **TORX® CON FORO**

Koken articolo		L mm	
RS 2025/7-L28(TH)	TH10, TH15, TH20, TH25, TH27, TH30, TH40	28	1



SERIE 7 PZ. CHIAVI A BUSSOLA MASCHIO TORX PLUS® **TORX Plus®**

Koken articolo		L mm	
RS 2025/7(IP)	10IP, 15IP, 20IP, 25IP, 27IP, 30IP, 40IP	28	1

TORX Plus	S mm	S mm	
8 IP	2.30	30 IP	5.60
9 IP	2.50	40 IP	6.70
10 IP	2.70	45 IP	7.90
15 IP	3.30	50 IP	8.90
20 IP	3.90	55 IP	11.30
25 IP	4.50	60 IP	13.30
27 IP	5.00		

TORX Plus CON FORO	S mm	S mm	
8 IPR	2.20	27 IPR	4.70
9 IPR	2.40	30 IPR	5.20
10 IPR	2.60	40 IPR	6.30
15 IPR	3.10	45 IPR	7.40
20 IPR	3.60	50 IPR	8.40
25 IPR	4.10	55 IPR	10.60

KOKEN 1/4"



MECCANISMO 20 DENTI



CRICCHETTO PORTABUSSOLA REVERSIBILE SNODATO

Koken articolo	D mm	T mm	L mm	
2774 JS	22	18.7	116	1



MECCANISMO 20 DENTI

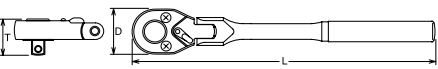

CRICCHETTO PORTABUSSOLA REVERSIBILE SNODATO

Koken articolo	D mm	T mm	L mm	
2774 PS	22	18.7	116	1



MECCANISMO 20 DENTI



CRICCHETTO PORTABUSSOLA REVERSIBILE SNODATO

Koken articolo	D mm	T mm	L mm	
2774 J	22	18.7	161	1



MECCANISMO 20 DENTI

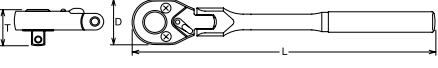

CRICCHETTO PORTABUSSOLA REVERSIBILE SNODATO

Koken articolo	D mm	T mm	L mm	
2774 P	22	18.7	161	1



MECCANISMO 44 DENTI

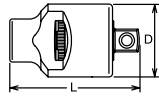

ADATTATORE CON CRICCHETTO REVERSIBILE SX/DX

Koken articolo	D mm	L mm	
2755	26	40	1



MECCANISMO 44 DENTI



ADATTATORE A MANOPOLA PORTA BUSSOLA

Koken articolo	D mm	L mm	
2756	26	22	1



PROLUNGHE

Koken articolo	D mm	L mm	
2760-28	12.3	28	1
2760-50	12.3	50	1
2760-75	12.3	75	1
2760-100	12.3	100	1
2760-150	12.3	150	1
2760-200	12.3	200	1
2760-250	12.3	250	1
2760-300	12.3	300	1
2760-350	12.3	350	1
2760-400	12.3	400	1
2760-600	12.3	600	1



SERIE 6 PZ. PROLUNGHE

Koken articolo	L mm	
PK 2760/6	28, 50, 100, 150, 200, 250	1

FLEX

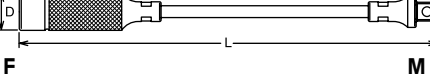



PROLUNGA FLESSIBILE

Koken articolo	D mm	L mm	
2762-300	13	300	1



TESTA MAGNETICA

Koken articolo	L mm	
2120	23	1



TESTA SFERICA

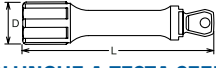

PROLUNGHE A TESTA SFERICA INCLINAZIONE MASSIMA 15°

SISTEMA WOBBLE-FIX CON DUE MODALITÀ DI UTILIZZO:

- PROLUNGA TESTA SFERICA MAX 15°
- PROLUNGA TRADIZIONALE

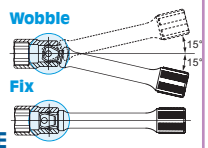

Koken articolo	D mm	L mm	
2763-28	12.3	28	1
2763-50	12.3	50	1
2763-75	12.3	75	1
2763-100	12.3	100	1
2763-150	12.3	150	1
2763-200	12.3	200	1
2763-250	12.3	250	1



TESTA SFERICA

PROLUNGHE A TESTA SFERICA INCLINAZIONE MASSIMA 15°

SISTEMA WOBBLE-FIX CON DUE MODALITÀ DI UTILIZZO:

- PROLUNGA TESTA SFERICA MAX 15°
- PROLUNGA TRADIZIONALE



Koken articolo	L mm	
PK 2763/6	28, 50, 100, 150, 200, 250	1



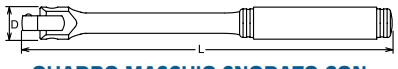

QUADRO MASCHIO SNODATO CON IMPUGNATURA

Koken articolo	D mm	L mm	
2768 J	14	130	1





QUADRO MASCHIO SNODATO CON IMPUGNATURA IN METALLO

Koken articolo	D mm	L mm	
2768 P	14	130	1



IMPUGNATURE PORTA BUSSOLE
attacco: 1/4"

Koken articolo	1/4"	L mm	
2769 N-150	1/4"	150	1
2769 N-220	1/4"	220	1



TESTA SFERICA

IMPUGNATURE A TESTA SFERICA PORTA BUSSOLE
SISTEMA WOBBLE-FIX CON DUE MODALITÀ DI UTILIZZO:
- PROLUNGA TESTA SFERICA ANGOLO 15°
- PROLUNGA TRADIZIONALE



attacco: 1/4"

Koken articolo	1/4"	L mm	
2769 NWF-150	1/4"	150	1
2769 NWF-220	1/4"	220	1



QUADRO MASCHIO PIEGHEVOLE 90° CON IMPUGNATURA

Koken articolo	L mm	
2769 H	160	1



QUADRO MASCHIO CON ASTA SCORREVOLE

Koken articolo	L mm	
2785	115	1



SFERA

SNODO

Koken articolo	L mm	
2770	33	1



SFERA

SNODO

Koken articolo	L mm	
2771	31	1

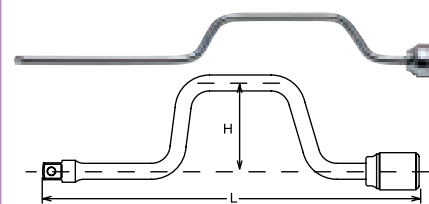

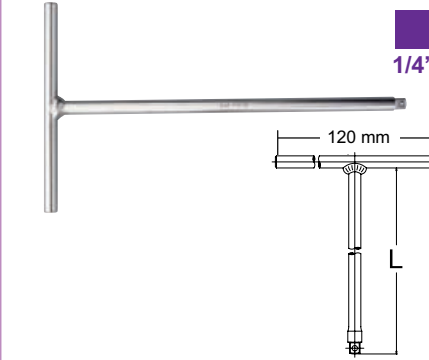

QUADRO MASCHIO CON MANOVELLA

Koken articolo	H mm	L mm	
2780	65	350	1



CHIAVI A "T" MASCHIO QUADRO 1/4" LARGHEZZA IMPUGNATURA 120 MM

Koken articolo	1/4"	L mm	
2715-1/4	1/4"	200	1



RACCORDO DI RIDUZIONE MASCHIO/FEMMINA CON SFERA DI TENUTA NEL QUADRO MASCHIO

SFERA

F M

JAPAN

Koken articolo	F	M	L mm	
2233 A	1/4"	3/8"	22	1
3322 A	3/8"	1/4"	24	1
3344 A	3/8"	1/2"	35	1
4433 A-35	1/2"	3/8"	35	1
4433 A-75	1/2"	3/8"	75	1
4433 A-125	1/2"	3/8"	125	1
4433 A-250	1/2"	3/8"	250	1
4433 A-600	1/2"	3/8"	600	1
4466 A	1/2"	3/4"	42	1
6644 A	3/4"	1/2"	47	1
6688 A	3/4"	1"	60	1
8866 A	1"	3/4"	60	1



SFERA





2756Z-3/8 3/8" 1/4"

2756Z-1/2 1/2" 1/4"







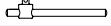

RIDUZIONI A SCOMPARSA

Koken articolo	F	M	D mm	L mm	
2756 Z-3/8	1/4"	3/8"	20.3	21.5	1
2756 Z-1/2	1/4"	1/2"	20.3	26	1





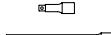
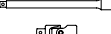

Koken articolo	DESCRIZIONE	
ESH 2001	Cassetta metallica 16 Pz. 310 x 86 x h 28 mm	
RICAMBI		
BUSSOLE  SURFACE DRIVE	2410M	4, 5, 5.5, 6, 7, 8, 9, 10, 11, 12, 13
ACCESSORI	2753J	
	2763-50	
	2760-150	
	2770	
	2785	



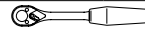

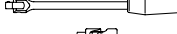

Koken articolo	DESCRIZIONE	
ENH 2003	Cassetta metallica 26 Pz. 310 x 86 x h 40 mm	
RICAMBI		
BUSSOLE 	2400M	5.5, 6, 7, 8, 9, 10, 11, 12, 13, 14
BUSSOLE 	2000.28	1, 2
BUSSOLE 	2005.25	4, 6, 8
BUSSOLE 	2010M.25	3, 4, 5, 6
ACCESSORI	2753J	
	2785	
	2769N-150	
	2760-50	
	2760-150	
	2770	
	2137 K	





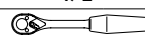

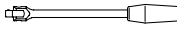

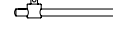

Koken articolo	DESCRIZIONE	
2251 M	Cassetta metallica 17 Pz. 192 x 122 x h 30 mm	
RICAMBI		
BUSSOLE 	2400M	4, 4.5, 5, 5.5, 6, 7, 8, 9, 10, 11, 13
ACCESSORI	2753J	
	2760-50	
	2760-150	
	2768J	
	2770	
	2785	

POLLICI



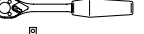
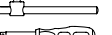

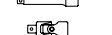







Koken articolo	DESCRIZIONE	
2251 A	Cassetta metallica 15 Pz. 192 x 122 x h 30 mm	
RICAMBI		
BUSSOLE 	2400A	3/16", 7/32", 1/4", 9/32", 5/16", 11/32", 3/8", 7/16", 1/2"
ACCESSORI	2753J	
	2760-50	
	2760-150	
	2768J	
	2770	
	2785	



Koken articolo	DESCRIZIONE	
2258 M	Cassetta metallica 31 Pz. 240 x 100 x h 32 mm	
RICAMBI		
BUSSOLE 	2400M	4, 4.5, 5, 5.5, 6, 7, 8, 9, 10, 11, 13
BUSSOLE 	2000.28	1, 2, 3
BUSSOLE 	2005.25	4, 6
BUSSOLE 	2010M.25	3, 4, 5, 6, 8
BUSSOLE 	2025.28	T10, T15, T20, T25, T30
ACCESSORI	2753J	
	2785	
	2769N-150	
	2760-100	
	2770	







Koken articolo	DESCRIZIONE	
2259 M	Cassetta metallica 31 Pz. 240 x 100 x h 32 mm CON CRICCHETTO SNODATO	
RICAMBI		
BUSSOLE 	2400M	4, 4.5, 5, 5.5, 6, 7, 8, 9, 10, 11, 13
BUSSOLE 	2000.28	1, 2, 3
BUSSOLE 	2005.25	4, 6
BUSSOLE 	2010M.25	3, 4, 5, 6, 8
BUSSOLE 	2025.28	T10, T15, T20, T25, T30
ACCESSORI	2774JS	
	2760-100	
	2769N-150	
	2770	
	2785	





POLLICI

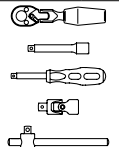



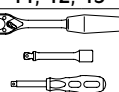

Koken articolo	DESCRIZIONE	
2263 A	Cassetta metallica 31 Pz. 240 x 100 x h 32 mm CON CRICCHETTO	
RICAMBI		
BUSSOLE 	2400A	1/8", 5/32", 3/16", 7/32", 1/4", 9/32", 5/16", 11/32", 3/8", 7/16", 1/2"
BUSSOLE 	2000.28	1, 2, 3
BUSSOLE 	2010A.25	1/8", 5/32", 3/16", 7/32", 1/4", 9/32", 5/16"
BUSSOLE 	2025.28	T10, T15, T20, T25, T30
ACCESSORI	2753N 2760-100 2769N-150 2770 2785	

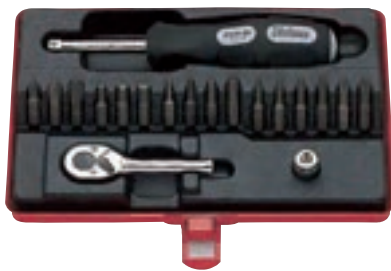



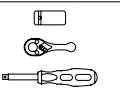

Koken articolo	DESCRIZIONE	
2277	Cassetta metallica 21 Pz. 310 x 86 x h 50 mm	
RICAMBI		
BUSSOLE 	2400M	5.5, 6, 7, 8, 9, 10, 11, 12, 13
BUSSOLE 	2300M	5.5, 6, 7, 8, 9, 10, 11, 12, 13
ACCESSORI	2753J 2763-75 2769N-150	





Koken articolo	DESCRIZIONE	
2276	Cassetta metallica 19 Pz. 192 x 122 x h 30 mm	
RICAMBI		
INSERTI 	108P	1, 2, 3
INSERTI 	108S	4, 5, 6
INSERTI 	108H	3, 4, 5, 6
INSERTI 	108T	T10, T15, T20, T25, T30
ACCESSORI	2137 K 2753PS 2769N-150	

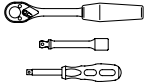

Koken articolo	DESCRIZIONE	
2275	Cassetta metallica 19 Pz. 192 x 122 x h 30 mm	
RICAMBI		
BUSSOLE 	2400M	5.5, 6, 7, 8, 10, 12, 13
BUSSOLE 	2000.28	1, 2, 3
BUSSOLE 	2005.25	6, 8
BUSSOLE 	2010M.25	3, 4, 5, 6
ACCESSORI	2753J 2763-50 2769N-150	

MILLIMETRI
E POLLICI



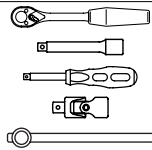

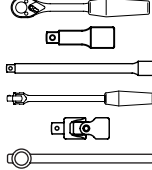

Koken articolo	DESCRIZIONE	
P 2201 AM	Cassetta plastica 25 Pz. 245 x 120 x h 45 mm	
RICAMBI		
BUSSOLE 	2400M	4, 5, 5.5, 6, 7, 8, 9, 10, 11, 12, 13
BUSSOLE 	2400A	3/16", 7/32", 1/4", 9/32", 5/16", 11/32", 3/8", 7/16", 1/2"
ACCESSORI	2753J 2760-100 2769N-150 2770 2785	

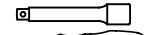

Koken articolo	DESCRIZIONE	
P 2251 M	Cassetta plastica 18 Pz. 245 x 120 x h 45 mm	
RICAMBI		
BUSSOLE 	2400M	4, 5, 5.5, 6, 7, 8, 9, 10, 11, 12, 13
ACCESSORI	2753J 2760-50 2760-150 2768J 2770 2785	

SET KOKEN 1/4"

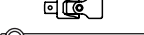

Koken articolo	DESCRIZIONE	
P 2258 M	Cassetta plastica 31 Pz. 245 x 120 x h 45 mm	
RICAMBI		
BUSSOLE ESAGONO	2400M	4, 5, 5.5, 6, 7, 8, 9, 10, 11, 12, 13
BUSSOLE	2000.28	1, 2, 3
BUSSOLE	2005.25	4, 6
BUSSOLE	2010M.25	3, 4, 5, 6, 8
BUSSOLE	2025.28	T10, T15, T20, T25, T30
ACCESSORI	2753J	
	2760-100	
	2769N-150	
	2770	
	2785	





ESAGONO

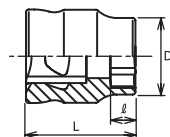

novità

CHIAVI A BUSSOLA
BOCCA ESAGONALE
EXTRA CORTE



Koken articolo	mm	D ₁ mm	L mm	
2400 MZ-4	4	6.4	14	1
2400 MZ-4.5	4.5	7	14	1
2400 MZ-5	5	7.6	14	1
2400 MZ-5.5	5.5	8.2	14	1
2400 MZ-6	6	8.8	14	1
2400 MZ-7	7	9.9	14	1
2400 MZ-8	8	11.1	15	1
2400 MZ-10	10	13.5	15	1
2400 MZ-11	11	14.7	15	1
2400 MZ-12	12	15.9	15	1
2400 MZ-13	13	17.1	15	1
2400 MZ-14	14	18.3	15	1

ESAGONO



novità

CHIAVI A BUSSOLA
BOCCA ESAGONALE
SEMI LUNGHE

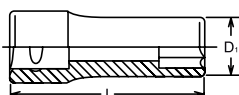

Koken articolo	mm	D ₁ mm	L mm	
2300 XZ-5.5	5.5	8.2	30	1
2300 XZ-6	6	8.8	30	1
2300 XZ-7	7	9.9	30	1
2300 XZ-8	8	11.1	30	1
2300 XZ-10	10	13.5	30	1
2300 XZ-11	11	14.7	30	1
2300 XZ-12	12	15.9	30	1
2300 XZ-13	13	17.1	30	1
2300 XZ-14	14	18.3	30	1

ESAGONO



novità

CHIAVI A BUSSOLA
BOCCA
ESAGONALE
LUNGHE

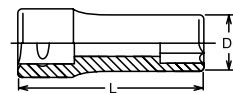

Koken articolo	mm	D ₁ mm	L mm	
2300 MZ-4	4	6.4	50	1
2300 MZ-4.5	4.5	7	50	1
2300 MZ-5	5	7.6	50	1
2300 MZ-5.5	5.5	8.2	50	1
2300 MZ-6	6	8.8	50	1
2300 MZ-7	7	9.9	50	1
2300 MZ-8	8	11.1	50	1
2300 MZ-10	10	13.5	50	1
2300 MZ-11	11	14.7	50	1
2300 MZ-12	12	15.9	50	1
2300 MZ-13	13	17.1	50	1
2300 MZ-14	14	18.3	50	1

NUT GRIP®
BLOCCADADI



novità

CHIAVI A BUSSOLA A
MANO SNODATE CON
SFERE DI TENUTA
BOCCA NUT GRIP

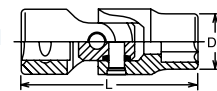

Koken articolo	mm	D ₁ mm	L mm	
2441 MZ-8	8	12.3	30.5	1
2441 MZ-10	10	14.3	30.5	1
2441 MZ-12	12	16.8	31.5	1
2441 MZ-13	13	18	31.5	1
2441 MZ-14	14	20	33	1

NUOVA SERIE Z KO-KEN MADE IN JAPAN

Progettata per soddisfare le crescenti esigenze del settore automotive dove si presentano design di motori più complessi e compatti.

KO-KEN ha studiato questa serie speciale di bussole con lunghezze e diametri ridotti ma mantenendo invariata l'eccellenza dei prodotti Made in Japan

Il design dei cricchetti a 72 denti permette di lavorare in modo efficiente in spazi ristretti e punti difficili da raggiungere senza rinunciare alla capacità di erogare una coppia elevata in spazi ristretti.

novità

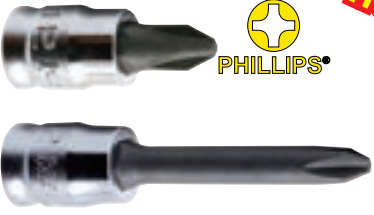

PHILLIPS®

CHIAVI A BUSSOLA A
CROCE PHILLIPS®

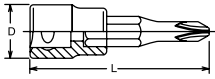

Koken articolo	Icona	D mm	L mm	Box
2000 Z-28-1	PH1	11.2	28	1
2000 Z-28-2	PH2	11.2	28	1
2000 Z-28-3	PH3	11.2	28	1
2000 Z-50-1	PH1	11.2	50	1
2000 Z-50-2	PH2	11.2	50	1
2000 Z-50-3	PH3	11.2	50	1

novità

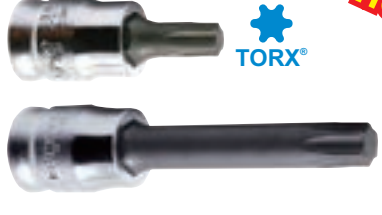

TORX®

CHIAVI A BUSSOLA
MASCHIO TORX®

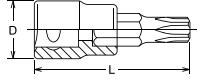

Koken articolo	Icona	D mm	L mm	Box
2025 Z-28-T10	TX 10	11.2	28	1
2025 Z-28-T15	TX 15	11.2	28	1
2025 Z-28-T20	TX 20	11.2	28	1
2025 Z-28-T25	TX 25	11.2	28	1
2025 Z-28-T27	TX 27	11.2	28	1
2025 Z-28-T30	TX 30	11.2	28	1
2025 Z-28-T40	TX 40	11.2	28	1
2025 Z-50-T10	TX 10	11.2	50	1
2025 Z-50-T15	TX 15	11.2	50	1
2025 Z-50-T20	TX 20	11.2	50	1
2025 Z-50-T25	TX 25	11.2	50	1
2025 Z-50-T27	TX 27	11.2	50	1
2025 Z-50-T30	TX 30	11.2	50	1
2025 Z-50-T40	TX 40	11.2	50	1

novità



MECCANISMO 72 DENTI

CRICCHETTO PORTABUSSOLA
REVERSIBILE SNODATO

Koken articolo	D mm	T mm	L mm	Box
2726 Z-160	20.5	17.1	160	1

novità



TAGLIO

CHIAVI A BUSSOLA
A TAGLIO

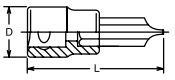

Koken articolo	Icona	D mm	L mm	Box
2005 Z-25-5	1.0 x 5.5	11.2	25	1
2005 Z-25-6	1.2 x 6.5	11.2	25	1

novità

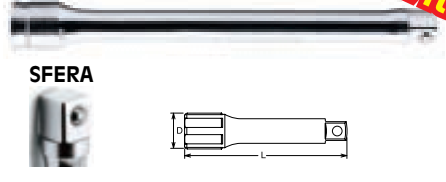

SFERA



PROLUNGA

Koken articolo	D mm	L mm	Box
2760 Z-50	11.5	50	1
2760 Z-100	11.5	100	1
2760 Z-150	11.5	150	1

novità



MECCANISMO 72 DENTI

CRICCHETTO PORTABUSSOLA REVERSIBILE

Koken articolo	D mm	T mm	L mm	Box
2725 Z	20,5	17,1	114	1

novità

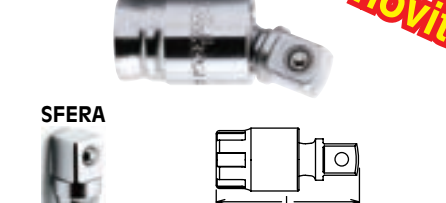

SFERA

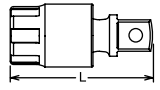

SNODO

Koken articolo	L mm	Box
2771 Z	29.9	1

novità



ESAGONO

CHIAVI A BUSSOLA
MASCHIO ESAGONALE

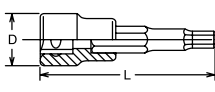

Koken articolo	mm	D mm	L mm	Box
2010 MZ-25-3	3	11.2	25	1
2010 MZ-25-4	4	11.2	25	1
2010 MZ-25-5	5	11.2	25	1
2010 MZ-25-6	6	11.2	25	1
2010 MZ-50-3	3	11.2	50	1
2010 MZ-50-4	4	11.2	50	1
2010 MZ-50-5	5	11.2	50	1
2010 MZ-50-6	6	11.2	50	1

novità



MECCANISMO 72 DENTI

CRICCHETTO PORTABUSSOLA REVERSIBILE

Koken articolo	D mm	T mm	L mm	Box
2725 Z-160	20,5	17,1	160	1

novità

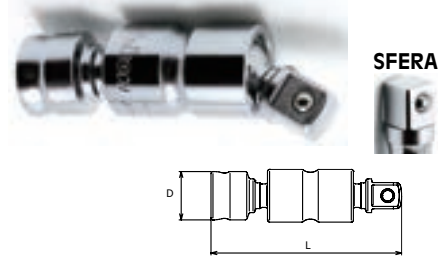

SFERA



DOPPIO
SNODO

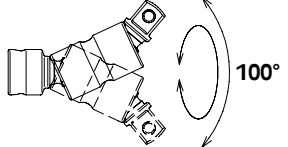

Koken articolo	D mm	L mm	Box
2772 Z	11.7	46	1

novità



MECCANISMO 72 DENTI

CRICCHETTO PORTABUSSOLA
REVERSIBILE SNODATO

Koken articolo	D mm	T mm	L mm	Box
2726 Z	20.5	17.1	114	1

SET KOKEN 1/4"



BUSSOLE CHROM-VANADIUM - SATINATE

Attacco: 1/4"
impronta: ESAGONO

BGS articolo	mm	L mm	
BGS 2473	3,5	25	1
BGS 2474	4	25	1
BGS 2475	4,5	25	1
BGS 2476	5	25	1
BGS 2477	5,5	25	1
BGS 2478	6	25	1
BGS 2479	7	25	1
BGS 2480	8	25	1
BGS 2481	9	25	1
BGS 2482	10	25	1
BGS 2483	11	25	1
BGS 2484	12	25	1
BGS 2485	13	25	1
BGS 2486	14	25	1



BUSSOLE CHROM-VANADIUM SATINATE, POLIGONALI

Attacco: 1/4"
impronta: POLIGONALE

BGS articolo	mm	L mm	
BGS 10774	4	25	1
BGS 10773	4,5	25	1
BGS 10775	5	25	1
BGS 10772	5,5	25	1
BGS 10776	6	25	1
BGS 10777	7	25	1
BGS 10778	8	25	1
BGS 10779	9	25	1
BGS 10780	10	25	1
BGS 10781	11	25	1
BGS 10782	12	25	1
BGS 10783	13	25	1
BGS 10784	14	25	1



BUSSOLE CHROM-VANADIUM - SATINATE SURFACE DRIVE

Attacco: 1/4"
impronta: SURFACE-DRIVE

BGS articolo	mm	L mm	
BGS 2344	4	25	1
BGS 2339	4,5	25	1
BGS 2345	5	25	1
BGS 2343	5,5	25	1
BGS 2346	6	25	1
BGS 2347	7	25	1
BGS 2348	8	25	1
BGS 2349	9	25	1
BGS 2350	10	25	1
BGS 2351	11	25	1
BGS 2352	12	25	1
BGS 2353	13	25	1
BGS 2354	14	25	1

POLLICI



BUSSOLE CHROM-VANADIUM - SATINATE IN POLLICI

Attacco: 1/4"
impronta: ESAGONO

BGS articolo	pollici	L mm	
BGS 10650	5/32"	25	1
BGS 10651	3/16"	25	1
BGS 10652	7/32"	25	1
BGS 10653	1/4"	25	1
BGS 10654	9/32"	25	1
BGS 10655	5/16"	25	1
BGS 10656	11/32"	25	1
BGS 10657	3/8"	25	1
BGS 10658	7/16"	25	1
BGS 10659	1/2"	25	1

POLLICI



BUSSOLE CHROM-VANADIUM - SATINATE POLIGONALI - IN POLLICI

Attacco: 1/4"
impronta: POLIGONALE

BGS articolo	pollici	L mm	
BGS 10870	5/32"	25	1
BGS 10871	3/16"	25	1
BGS 10872	7/32"	25	1
BGS 10873	1/4"	25	1
BGS 10874	9/32"	25	1
BGS 10875	5/16"	25	1
BGS 10876	11/32"	25	1
BGS 10877	3/8"	25	1
BGS 10878	7/16"	25	1
BGS 10879	15/32"	25	1
BGS 10880	1/2"	25	1
BGS 10881	9/16"	25	1



BUSSOLE SERIE TORX® AL CHROM-VANADIUM

attacco: 1/4"
impronta: TORX®

BGS articolo		L mm	
BGS 6404	E 4	25	1
BGS 6405	E 5	25	1
BGS 6406	E 6	25	1
BGS 6407	E 7	25	1
BGS 6408	E 8	25	1
BGS 6430	E 10	25	1
BGS 6431	E 11	25	1

TORX®	S mm	S mm	
E 4	3.70	E 16	14.60
E 5	4.60	E 18	16.50
E 6	5.60	E 20	18.30
E 7	6.10	E 22	20.10
E 8	7.40	E 24	22.00
E 10	9.30	E 26	23.70
E 11	9.90	E 28	25.50
E 12	11.00	E 30	27.30
E 14	12.80	E 32	29.00



BUSSOLE MULTIMPRONTA SPLINE DRIVE

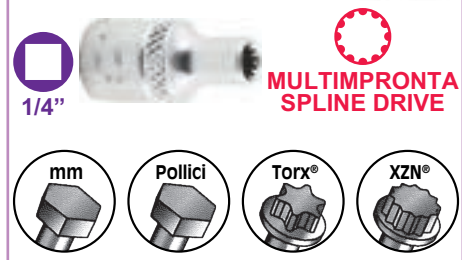

BUSSOLE CHROM-VANADIUM MULTIMPRONTA "SPLINE DRIVE"

Attacco: 1/4"
impronta: SPLINE DRIVE

BGS articolo	mm	L mm	
BGS 10104	4	25	1
BGS 10101	4,5	25	1
BGS 10105	5	25	1
BGS 10102	5,5	25	1
BGS 10106	6	25	1
BGS 10107	7	25	1
BGS 10108	8	25	1
BGS 10109	9	25	1
BGS 10110	10	25	1
BGS 10111	11	25	1
BGS 10112	12	25	1
BGS 10113	13	25	1
BGS 10114	14	25	1



BGS articolo	DESCRIZIONE
BGS 2150	SERIE 13 PEZZI, BUSSOLE MULTIMPRONTA, ATT. 1/4"

- CARATTERISTICHE**
- lo speciale profilo "multimpronta" consente l'uso universale Torx (E5-E18), in misure metriche (4-14 mm) ed in pollici (5/32"-1/2")
 - su guida metallica
 - peso: 250 g



BGS articolo	DESCRIZIONE
BGS 9102	SERIE 13 PEZZI, BUSSOLE ESAGONALI 4-14 MM, ATT. 1/4"

- CARATTERISTICHE**
- misure: 4-4,5-5-5,5-6-7-8-9-10-11-12-13-14 mm
 - finitura cromata satinata
 - zigrinate
 - su guida metallica
 - peso: 270 g



BGS articolo	DESCRIZIONE
BGS 220	SERIE 10 PEZZI, BUSSOLE ESAGONALI SNODATE 5-13 MM, ATT. 1/4"

- CARATTERISTICHE**
- misure: 5-5,5-6-7-8-9-10-11-12-13 mm
 - finitura cromata lucida
 - su guida metallica
 - peso: 310 g



BGS articolo	DESCRIZIONE
BGS 2433	SERIE 11 PEZZI, BUSSOLE ESAGONALI IN POLLICI, ATT. 1/4"

- CARATTERISTICHE**
- esagonali
 - 3/16", 7/32", 1/4", 9/32", 5/16", 11/32", 3/8", 13/32", 7/16", 15/32", 1/2"
 - finitura cromata satinata
 - su guida metallica
 - peso: 220 g



BGS articolo	DESCRIZIONE
BGS 2269	SERIE 13 PEZZI, BUSSOLE POLIGONALI 4-14 MM, ATT. 1/4"

- CARATTERISTICHE**
- misure: 4-4,5-5-5,5-6-7-8-9-10-11-12-13-14 mm
 - su guida metallica
 - peso: 260 g

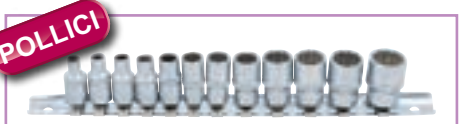

BGS articolo	DESCRIZIONE
BGS 2755	SERIE 12 PEZZI, BUSSOLE POLIGONALI IN POLLICI, ATT. 1/4"

- CARATTERISTICHE**
- poligonali
 - 5/32", 3/16", 7/32", 1/4", 9/32", 5/16", 11/32", 3/8", 7/16", 15/32", 1/2", 9/16"
 - finitura satinata cromata
 - peso: 250 g



BGS articolo	DESCRIZIONE
BGS 6402	SERIE 7 PEZZI, BUSSOLE TORX FEMMINA, E4 - E11, ATT. 1/4"

- CARATTERISTICHE**
- zigrinate
 - su guida metallica
 - finitura cromata satinata
 - misure: E4 - E5 - E6 - E7 - E8 - E10 - E11
 - peso: 130 g

1/4"



BGS articolo	DESCRIZIONE
BGS 9548	SERIE 10 PEZZI, BUSSOLE TORX FEMMINA, E4 - E16, ATT. 1/4" - 3/8"

CARATTERISTICHE

- zigrinate
- su guida metallica
- finitura cromata satinata
- misure:
 - attacco 1/4": E4 - E5 - E6 - E7 - E8
 - attacco 3/8": E10 - E11 - E12 - E14 - E16
- peso: 250 g



BGS articolo	DESCRIZIONE
BGS 2027	SERIE 7 PEZZI, BUSSOLE TORX, ATT. 1/4" - 3/8"

CARATTERISTICHE

- comprende:
 - att. 1/4": E6 - E7 - E8
 - att. 3/8": E10 - E12 - E14 - E16
- finitura cromata satinata
- peso: 200 g



BGS articolo	DESCRIZIONE
BGS 2038	SERIE 12 PEZZI, BUSSOLE TORX, ATT. 1/4" - 3/8"

CARATTERISTICHE

- finitura cromata satinata
- attacco 1/4": E 4-5-6-7-8
- attacco 3/8": E 10-11-12-14-16-18-20
- peso: 370 g



BGS articolo	DESCRIZIONE
BGS 9588	SERIE 6 PEZZI, BUSSOLE TORX PLUS 6EPL - 12EPL, ATT. 1/4"

CARATTERISTICHE

- misure:
 - 6 EPL - 7 EPL - 8 EPL - 10 EPL - 11 EPL - 12 EPL
- su guida metallica
- peso: 150 g

TORX PLUS®		S	S
		mm	mm
E 4	3.70	E 16	14.60
E 5	4.60	E 18	16.50
E 6	5.60	E 20	18.30
E 7	6.10	E 22	20.10
E 8	7.40	E 24	22.00
E 10	9.30	E 26	23.70
E 11	9.90	E 28	25.50
E 12	11.00	E 30	27.30
E 14	12.80	E 32	29.00

**LUNGHE - SATINATE**
 Attacco: 1/4"
 impronta: ESAGONO

BGS articolo	mm	L mm	
BGS 10504	4	50	1
3720-0045	4,5	50	1
BGS 10505	5	50	1
BGS 10503	5,5	50	1
BGS 10506	6	50	1
BGS 10507	7	50	1
BGS 10508	8	50	1
BGS 10509	9	50	1
BGS 10510	10	50	1
BGS 10511	11	50	1
BGS 10512	12	50	1
BGS 10513	13	50	1
BGS 10514	14	50	1

POLLICI

**LUNGHE - SATINATE
IN POLLICI**
 Attacco: 1/4"
 impronta: ESAGONO

BGS articolo	pollici	L mm	
BGS 10670	1/4"	50	1
BGS 10671	5/16"	50	1
BGS 10672	3/8"	50	1
BGS 10673	7/16"	50	1
BGS 10674	1/2"	50	1



1/4"

POLIGONALE



LUNGHE - SATINATE

Attacco: 1/4"
impronta: POLIGONALE

BGS articolo	mm	L mm	
BGS 10702	4	50	1
BGS 10704	5	50	1
BGS 10705	5,5	50	1
BGS 10706	6	50	1
BGS 10707	7	50	1
BGS 10708	8	50	1
BGS 10709	9	50	1
BGS 10710	10	50	1
BGS 10711	11	50	1
BGS 10712	12	50	1
BGS 10713	13	50	1



1/4"

SURFACE DRIVE



BUSSOLE CHROM-VANADIUM - SATINATE LUNGHE - SURFACE DRIVE

Attacco: 1/4"
impronta: SURFACE-DRIVE

BGS articolo	mm	L mm	
BGS 2964	4	50	1
BGS 2965	5	50	1
BGS 2966	6	50	1
BGS 2967	7	50	1
BGS 2968	8	50	1
BGS 2969	9	50	1
BGS 2970	10	50	1
BGS 2971	11	50	1
BGS 2972	12	50	1
BGS 2973	13	50	1
BGS 2974	14	50	1

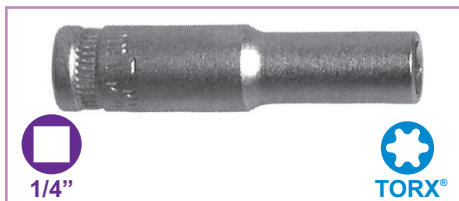

1/4"

TORX®

TORX® LUNGHE

attacco: 1/4"
impronta: TORX®

FERMEC articolo	mm	L mm	
3723-0040	E 4	50	1
3723-0050	E 5	50	1
3723-0060	E 6	50	1
3723-0070	E 7	50	1
3723-0080	E 8	50	1
3723-0100	E 10	50	1



1/4"

MULTIMPRONTA SPLINE DRIVE



BUSSOLE CHROM-VANADIUM MULTIMPRONTA "SPLINE DRIVE" - LUNGHE

Attacco: 1/4"
impronta: SPLINE DRIVE

BGS articolo	mm	L mm	
BGS 10154	4	50	1
BGS 10155	5	50	1
BGS 10156	6	50	1
BGS 10157	7	50	1
BGS 10158	8	50	1
BGS 10159	9	50	1
BGS 10160	10	50	1
BGS 10161	11	50	1
BGS 10162	12	50	1
BGS 10163	13	50	1



1/4"

CV

PRO+

ESAGONO

BGS articolo

DESCRIZIONE

BGS 2221

SERIE 11 PEZZI, BUSSOLE TIPO LUNGO ESAGONALI, 4-13 MM, ATT. 1/4"

CARATTERISTICHE

- esagonali
- finitura satinata cromata
- 4-5-5,5-6-7-8-9-10-11-12-13 mm
- su guida metallica
- peso: 380 g



1/4"

PRO+

CV

POLIGONALE

BGS articolo

DESCRIZIONE

BGS 5251

SERIE 11 PEZZI, BUSSOLE TIPO LUNGO, POLIGONALI, ATT. 1/4"

CARATTERISTICHE

- misure: 4-5-5,5-6-7-8-9-10-11-12-13 mm
- finitura satinata cromata
- su supporto in plastica
- peso: 390 g

1/4"

POLLICI

1/4"



ESAGONO



CV

PRO+

articolo

DESCRIZIONE

BGS 2429

**SERIE 11 PEZZI,
 BUSSOLE ESAGONALI
 IN POLLICI, TIPO
 LUNGO, ATT. 1/4"**

CARATTERISTICHE

- esagonali
- misure: 3/16", 7/32", 1/4", 9/32", 5/16", 11/32", 3/8", 13/32", 7/16", 15/32", 1/2"
- finitura satinata cromata
- peso: 410 g

POLLICI

1/4"



POLIGONALE

PRO+



CV

articolo

DESCRIZIONE

BGS 2757

**SET 12 PEZZI,
 BUSSOLE POLIGONALI
 IN POLLICI, TIPO
 LUNGO, ATT. 1/4"**

CARATTERISTICHE

- poligonali
- misure: 5/32", 3/16", 7/32", 1/4", 9/32", 5/16", 11/32", 3/8", 7/16", 15/32", 1/2", 9/16"
- finitura cromata satinata
- peso: 450 g



1/4"

PRO+

CV



TORX®

articolo

DESCRIZIONE

BGS 6403



**SERIE 6 PEZZI,
 BUSSOLE TORX
 TORX E4 - E10, TIPO
 LUNGO, ATT. 1/4"**

CARATTERISTICHE



- misure: E4 - E5 - E6 - E7 - E8 - E10
- lunghezza: 50 mm
- peso: 180 g



TORX®	S mm	S mm	
E 4	3.70	E 16	14.60
E 5	4.60	E 18	16.50
E 6	5.60	E 20	18.30
E 7	6.10	E 22	20.10
E 8	7.40	E 24	22.00
E 10	9.30	E 26	23.70
E 11	9.90	E 28	25.50
E 12	11.00	E 30	27.30
E 14	12.80	E 32	29.00

NOTE



 1/4"  **PHILLIPS®**



PHILLIPS®
attacco: 1/4"
impronta: PHILLIPS®

BGS articolo		L mm	
BGS 2504	PH 0	38	1
BGS 2487	PH 1	38	1
BGS 2488	PH 2	38	1
BGS 2489	PH 3	38	1



 1/4"  **POZIDRIV®**



POZIDRIV®
attacco: 1/4"
impronta: POZIDRIV®

BGS articolo		L mm	
BGS 2505	PZ 0	38	1
BGS 2490	PZ 1	38	1
BGS 2491	PZ 2	38	1
BGS 2492	PZ 3	38	1



 1/4"  **TAGLIO**

TAGLIO
attacco: 1/4"
impronta: TAGLIO

BGS articolo		L mm	
3724-0030	3	35	1
BGS 2493	4	38	1
3724-0045	4,5	35	1
BGS 2494	5,5	38	1
3724-0060	6	35	1
BGS 2495	6,5	38	1
BGS 2496	7	38	1

 1/4"  **ESAGONO**



BRUGOLA TCCE
attacco: 1/4"
impronta: ESAGONO

BGS articolo		L mm	
BGS 5152	1,5	38	1
BGS 5153	2	38	1
BGS 5154	2,5	38	1
BGS 2497	3	38	1
BGS 5155	3,5	38	1
BGS 2498	4	38	1
BGS 2499	5	38	1
BGS 9466 <small>novità</small>	5,5	38	1
BGS 2500	6	38	1
BGS 2501	7	38	1
BGS 2502	8	38	1
BGS 2161-10	10	38	1
BGS 2161-12	12	38	1



 1/4"  **ESAGONO**

POLLICI
BRUGOLA TCCE - IN POLLICI
attacco: 1/4"
impronta: ESAGONO

BGS articolo		L mm	
BGS 2740	3/32"	38	1
BGS 2741	1/8"	38	1
BGS 2742	5/32"	38	1
BGS 2743	3/16"	38	1
BGS 2744	7/32"	38	1
BGS 2745	1/4"	38	1
BGS 2746	9/32"	38	1
BGS 2747	5/16"	38	1
BGS 2748	3/8"	38	1

 1/4"  **ESAGONO**



BRUGOLA TESTA SFERICA
attacco: 1/4"
impronta: ESAGONO

BGS articolo		L mm	
3732-0020	2	35	1
3732-0025	2,5	35	1
3732-0030	3	35	1
3732-0040	4	35	1
3732-0050	5	35	1
3732-0060	6	35	1
3732-0080	8	35	1
BGS 9833	4	300	1



 1/4"  **ESAGONO CON FORO**

BRUGOLA CON FORO
attacco: 1/4"
impronta: ESAGONO

BGS articolo		L mm	
BGS 5156-2	2	38	1
BGS 5156-2-5	2,5	38	1
BGS 5156-3	3	38	1
BGS 5156-4	4	38	1
BGS 5156-5	5	38	1
BGS 5156-5-5	5,5	38	1
BGS 5156-6	6	38	1
BGS 5156-7	7	38	1

 1/4"  **TORX®**

TORX®
attacco: 1/4"
impronta: TORX®

BGS articolo		L mm	
3733-0006	TX 6	35	1
BGS 2557	TX 7	38	1
BGS 2589	TX 8	38	1
BGS 2588	TX 9	38	1
BGS 2590	TX 10	38	1
BGS 2591	TX 15	38	1
BGS 2592	TX 20	38	1
BGS 2593	TX 25	38	1
BGS 2594	TX 27	38	1
BGS 2595	TX 30	38	1
BGS 2565	TX 35	38	1
BGS 2596	TX 40	38	1
BGS 2164-T45	TX 45	38	1
BGS 2164-T50	TX 50	38	1
BGS 2565-75	TX 35	75	1
BGS 4202	TX 30	400	1

TORX®	S mm	S mm	
T 6	1.70	T 40	6.70
T 7	2.00	T 45	7.90
T 8	2.30	T 50	8.90
T 9	2.50	T 55	11.30
T 10	2.70	T 60	13.30
T 15	3.30	T 70	15.60
T 20	3.90	T 80	17.60
T 25	4.50	T 90	20.00
T 27	5.00	T 100	22.20
T 30	5.60		



attacco: 1/4"
impronta: TORX® C/FORO

BGS articolo	TH	L mm	1
3734-0006	TH 6	35	1
3734-0007	TH 7	35	1
BGS 2356	TH 8	38	1
BGS 2364	TH 9	38	1
BGS 2357	TH 10	38	1
BGS 2358	TH 15	38	1
BGS 2359	TH 20	38	1
BGS 2360	TH 25	38	1
BGS 2361	TH 27	38	1
BGS 2362	TH 30	38	1
BGS 2363	TH 40	38	1
BGS 2165-T45	TH 45	38	1
BGS 2165-T50	TH 50	38	1
BGS 4203	TH 30	100	1



attacco: 1/4"
impronta: XZN

BGS articolo	M	L mm	1
BGS 5105-M4	M 4	38	1
BGS 5105-M5	M 5	38	1
BGS 5105-M6	M 6	38	1
BGS 2503	M 8	38	1
BGS 2506	M 10	38	1
BGS 2507	M 12	38	1

XZN	S mm	S mm
M 4	3,60	M12 11,50
M 5	4,80	M14 13,30
M 6	6,10	M16 15,70
M 8	7,30	M18 16,90
M10	9,70	



BGS articolo	DESCRIZIONE
BGS 2163	SERIE 12 PEZZI, BUSSOLE PH, PZ E TAGLIO, ATT. 1/4"

- CARATTERISTICHE**
- comprende:
 - bussole taglio: 4 - 5,5 - 6,5 - 7 mm
 - bussole PH: 0 - 1 - 2 - 3
 - bussole PZ: 0 - 1 - 2 - 3
 - finitura cromata satinata
 - su guida metallica
 - peso: 250 g



attacco: DIN 3121
impronta: 5 PUNTE C/FORO

BGS articolo	T	L mm	1
BGS 5184-TS10	T 10	38	1
BGS 5184-TS15	T 15	38	1
BGS 5184-TS20	T 20	38	1
BGS 5184-TS25	T 25	38	1
BGS 5184-TS27	T 27	38	1
BGS 5184-TS30	T 30	38	1
BGS 5184-TS40	T 40	38	1
BGS 5184-TS45	T 45	38	1
BGS 5184-TS50	T 50	38	1



BGS articolo	DESCRIZIONE
BGS 2355	SET 9 PEZZI, CHIAVI A BUSSOLA 5 PUNTE C/FORO, ATT. 1/4"

- CARATTERISTICHE**
- TS-10-15-20-25-27-30-40-45-50
 - per fissaggio di pompe nei dispositivi antifurto di MB Atego, Actros e Rover
 - su guida porta bussola, imballaggio supplementare in custodia di plastica
 - peso: 250 g

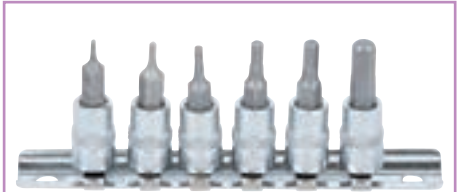

BGS articolo	DESCRIZIONE
BGS 5151	SERIE 6 PEZZI, CHIAVI A BUSSOLA ESAGONO MASCHIO, ATT. 1/4"

- CARATTERISTICHE**
- misure: 1,5 - 2 - 2,5 - 3,5 - 4 - 6 mm
 - attacco quadro 1/4"
 - su guida metallica
 - peso: 140 g

PENTALOBATA	S mm	S mm
8 PR	2.20	27 PR 4.70
9 PR	2.40	30 PR 5.20
10 PR	2.60	40 PR 6.30
15 PR	3.10	45 PR 7.40
20 PR	3.60	50 PR 8.40
25 PR	4.10	55 PR 10.60

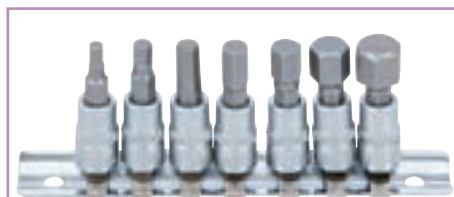

1/4"



ESAGONO

PRO+



CV

BGS
articolo

DESCRIZIONE

BGS 2161

**SERIE 7 PEZZI,
BUSSOLE ESAGONALI,
ATT. 1/4"**

CARATTERISTICHE

- misure: 4 - 5 - 6 - 7 - 8 - 10 - 12 mm
- finitura cromata satinata
- su guida metallica
- peso: 170 g

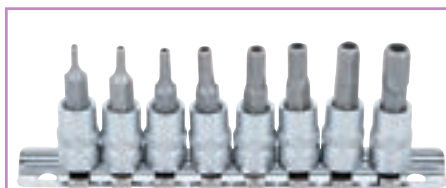

1/4"



ESAGONO
CON FORO

CV
S2

PRO+

BGS
articolo

DESCRIZIONE

BGS 5156

**SERIE 8 PEZZI,
CHIAVI A BUSSOLA,
ESAGONO CON FORO,
ATT. 1/4"**

CARATTERISTICHE

- zigrinate
- su guida metallica
- finitura: satinata cromata
- lunghezza: 38 mm
- attacco: 1/4"
- impronta: esagono con foro
- misure: 2 - 2,5 - 3 - 4 - 5 - 5,5 - 6 - 7 mm
- peso: 140 g



novità

PRO+

CV

ESAGONO



1/4" 1/2"

BGS
articolo

DESCRIZIONE

BGS 5171

**SET 18 PEZZI, CHIAVI A
BUSSOLA
ATTACCO 1/4" E 1/2",
ESAGONALI**

CARATTERISTICHE

- per uso a mano
- zigrinate
- impronta: Esagonale
- materiale: acciaio al cromo vanadio (S2)
- attacco quadro
- finitura: cromata satinato
- comprende:
 - bussole attacco 1/4", Esagonali:
3 mm (BGS 2497) - 4 mm (BGS 2498)
5 mm (BGS 2499) - 6 mm (BGS 2500)
7 mm (BGS 2501) - 8 mm (BGS 2502)
 - bussole attacco 1/2", Esagonali:
6 mm (BGS 4252) - 7 mm (BGS 4253)
8 mm (BGS 4254) - 10 mm (BGS 4255)
12 mm (BGS 4256) - 14 mm (BGS 4257)
 - bussole , attacco 1/2", lunghezza 100 mm,
Esagonali:
5 mm (BGS 4260) - 6 mm (BGS 4261)
7 mm (BGS 4262) - 8 mm (BGS 4263)
10 mm (BGS 4264) - 12 mm (BGS 4265)
- peso: 1,8 kg



POLLICI



1/4"

PRO+

CV

ESAGONO

BGS
articolo

DESCRIZIONE

BGS 2749

**SERIE 9 PEZZI,
CHIAVI A
BUSSOLA ESAGONO
MASCHIO IN POLLICI,
ATT. 1/4"**

CARATTERISTICHE

- misure: 3/32", 1/8", 5/32", 3/16", 7/32", 1/4", 9/32", 5/16", 3/8";
- attacco quadro 1/4"
- su guida metallica
- peso: 200 g



1/4"-3/8"-1/2"



ESAGONO



CV

PRO+

BGS
articolo

DESCRIZIONE

BGS 5099

**SERIE 10 PEZZI,
CHIAVI A BUSSOLA
ESAGONALI EXTRA
CORTE, 4 - 19 MM,
ATT. 1/4" - 3/8" - 1/2"**

CARATTERISTICHE

- attacco 1/4", lunghezza 30 mm: 4 - 5 - 6 - 7 - 8 mm
- attacco 3/8", lunghezza 38 mm: 10 - 12 - 14 mm
- attacco 1/2", lunghezza 48 mm: 17 - 19 mm
- zigrinate
- finitura cromata satinata
- su guida metallica
- peso: 580 g

MILLIMETRI
E POLLICI

novità



PRO+

BGS
articolo

DESCRIZIONE

BGS 74258

SET 32 PEZZI, CHIAVI A
BUSSOLA ESAGONALI,
METRICHE 2-19 MM &
IN POLLICI 1/4 - 9/16",
ATT. 1/4"-3/8"-1/2"

CARATTERISTICHE

- per uso a mano
- zigrinate
- impronta: esagonale
- attacco: 1/4", 3/8", 1/2"
- materiale: acciaio al cromo vanadio (S2)
- comprende:
 - bussole attacco 1/4", esagonali metriche: 2 mm (BGS 5153), 2,5 mm (BGS 5154), 3 mm (BGS 2497), 4 mm (BGS 2498), 5 mm (BGS 2499), 5,5 mm (BGS 9466), 6 mm (BGS 2500)
 - bussole attacco 1/4", esagonali in pollici: 5/64", 3/32" (BGS 2740), 1/8" (BGS 2741), 5/32" (BGS 2742), 3/16" (BGS 2743), 7/32" (BGS 2744), 1/4" (BGS 2745)
 - bussole attacco 3/8", esagonali metriche: 7 mm (BGS 2580), 8 mm (BGS 2581), 9 mm (BGS 2583), 10 mm (BGS 2582), 12 mm (BGS 2584)
 - bussole attacco 3/8", esagonali in pollici: 9/32" (BGS 2730), 5/16" (BGS 2727), 3/8" (BGS 2729), 7/16", 1/2"
 - bussole attacco 1/2", esagonali metriche: 14 mm (BGS 4257), 15 mm, 17 mm (BGS 5184-H17), 19 mm (BGS 5184-H19)
 - bussole attacco 1/2", esagonali in pollici: 9/16" (BGS 2738), 5/8" (BGS 2751), 11/16" (BGS 2752), 3/4" (BGS 2754)
- peso 2,6 kg

TORX®
CON FORO

- 11 BUSSOLE 1/4" CON INSERTI TORX®
- TX 6-7-8-9-10-15-20-25-27-30-40

attacco: 1/4"

impronta: TORX® - TORX® C/FORO

BGS
articolo

DESCRIZIONE

articolo	DESCRIZIONE	quantità
3760	CASSETTA METALLICA 14 PEZZI TORX®	1
3761	CASSETTA METALLICA 11 PEZZI TORX® C/FORO	1



PRO+

CV

BGS
articolo

DESCRIZIONE

SET 7 PEZZI,
BUSSOLE CON INSERTI
TORX, TESTA SFERICA,
ATT. 1/4"

CARATTERISTICHE

- ideale per lavorare in spazi ridotti
- misure: TX10-TX15-TX20-TX25-TX27-TX30-TX40
- lunghezza: 130 mm
- peso: 550 g



PRO+

BGS
articolo

DESCRIZIONE

BGS 2164

SERIE 9 PEZZI,
CHIAVI A BUSSOLA
CON TORX MASCHIO,
TX10 - TX50, ATT. 1/4"

CARATTERISTICHE

- misure: TX10-TX15-TX20-TX25-TX27-TX30-TX40-TX45-TX50
- finitura cromata satinata
- zigrinate
- su guida metallica
- peso: 190 g



1/4"-3/8"-1/2"



PRO+

BGS
articolo

DESCRIZIONE

BGS 5098

SERIE 12 PEZZI,
CHIAVI A BUSSOLA
TORX EXTRA CORTE,
T8 - T60,
ATT. 1/4" - 3/8" - 1/2"

CARATTERISTICHE

- attacco 1/4", lunghezza 30 mm: TX8 - TX10 - TX15 - TX20 - TX25 - Tx27
- attacco 3/8", lunghezza 38 mm: Tx30 - T4x0 - Tx45 - Tx50 - Tx55
- attacco 1/2", lunghezza 48 mm: Tx60
- zigrinate
- finitura cromata satinata
- su guida metallica
- peso: 400 g



1/4"   

BGS articolo	DESCRIZIONE
BGS 9158	SERIE 8 PEZZI, CHIAVI A BUSSOLA SNODATE, TORX MASCHIO, TX8-TX40, ATT. 1/4"

CARATTERISTICHE

- misure: TX8 - TX10 - TX15 - TX20 - TX25 - TX27 - TX30 - TX40
- lunghezza: 42 mm
- finitura cromata lucida
- su guida metallica
- peso: 250 g



   1/4" 1/2"

BGS articolo	DESCRIZIONE
BGS 5173	SET 18 PEZZI, CHIAVI A BUSSOLA ATTACCO 1/4" E 1/2", TORX

CARATTERISTICHE

- per uso a mano
- zigrinate
- impronta: Torx
- zigrinate
- materiale: acciaio al cromo vanadio (S2)
- attacco quadro
- comprende:
 - bussole attacco 1/4", Torx, **lunghezza 38 mm:** TX10 (BGS 2590) - TX15 (BGS 2591) TX20 (BGS 2592) - TX25 (BGS 2593) TX27 (BGS 2594) - TX30 (BGS 2595)
 - bussole attacco 1/2", Torx, **lunghezza 55 mm:** TX30 (BGS 4371) - TX40 (BGS 4372) TX45 (BGS 4373) - TX50 (BGS 4374) TX55 (BGS 4375) - TX60 (BGS 4378)
 - bussole, attacco 1/2", Torx, **lunghezza 100 mm:** TX30 (BGS 4471) - TX40 (BGS 4472) TX45 (BGS 4473) - TX50 (BGS 4474) TX55 (BGS 4475) - T60 (BGS 4476)
- peso 1,5 kg



1/4"   

BGS articolo	DESCRIZIONE
BGS 2165	SERIE 9 PEZZI, CHIAVI A BUSSOLA TORX CON FORO MASCHIO, TH10-TH50, ATT. 1/4"

CARATTERISTICHE

- misure: TH10 - TH15 - TH20 - TH25 - TH30 - TH40 - TH45 - TH50
- finitura cromata satinata, zigrinate
- su guida metallica
- peso: 180 g



   1/4" 1/2"

BGS articolo	DESCRIZIONE
BGS 5174	SET 18 PEZZI, CHIAVI A BUSSOLA ATTACCO 1/4" E 1/2", TORX C/FORO

CARATTERISTICHE

- per uso a mano
- zigrinate
- impronta: Torx C/ FORO
- zigrinate
- materiale: acciaio al cromo vanadio (S2)
- attacco quadro
- finitura: cromata satinata
- comprende:
 - bussole attacco 1/4", Torx C/FORO, **lunghezza 38 mm:** TH10 (BGS 2357) - TH15 (BGS 2358) TH20 (BGS 2359) - TH25 (BGS 2360) TH27 (BGS 2361) - TH30 (BGS 2362)
 - bussole attacco 1/2", Torx C/FORO, **lunghezza 55 mm:** TH30 - TH40 (BGS 4326) TH45 (BGS 4327) - TH50 (BGS 4328) TH55 (BGS 4329) - TH60 (BGS 4376)
 - bussole, attacco 1/2", Torx C/FORO, **lunghezza 100 mm:** TH30 - TH40 - TH45 - TH50 - TH55 - TH60
- peso 1,5 kg





1/4"  

BGS articolo	DESCRIZIONE
BGS 2162	SERIE 6 PEZZI, BUSSOLE XZN, ATT. 1/4"

CARATTERISTICHE

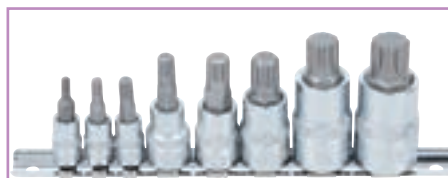
- misure: M4 - M5 - M6 - M8 - M10 - M12
- finitura cromata satinata
- su guida metallica
- peso: 170 g



1/4" - 3/8" - 1/2"  

BGS articolo	DESCRIZIONE
BGS 5105	SERIE 8 PEZZI, BUSSOLE XZN, ATT. 1/4" - 3/8" - 1/2"

CARATTERISTICHE

- comprende:
 - attacco 1/4": M4-M5-M6
 - attacco 3/8": M8-10-12
 - attacco 1/2": M-14-16
- finitura cromata satinata
- su guida metallica
- peso: 470 g

1/4"

BGS
 articolo

DESCRIZIONE

BGS 5172
**SET 18 PEZZI, CHIAVI A
 BUSSOLA
 ATTACCO 1/4" E 1/2",
 XZN**

CARATTERISTICHE

- per uso a mano
- zigrinate
- impronta: XZN
- zigrinate
- materiale: acciaio al cromo vanadio (S2)
- attacco quadro
- comprende:
 - bussole attacco 1/4", XZN, **lunghezza 38 mm:**
M4 (BGS 5105-M4) - M5 (BGS 5105-M5)
M6 (BGS 5105-M6) - M8 (BGS 2503)
M10 (BGS 2506) - M12 (BGS 2507)
 - bussole attacco 1/2", XZN, **lunghezza 55 mm:**
M8 (BGS 4352) - M10 (BGS 4353)
M12 (BGS 4354) - M14 (BGS 4344)
M16 (BGS 4356) - M18
 - bussole, attacco 1/2", XZN, **lunghezza 100 mm:**
M8 (BGS 4361) - M10 (BGS 4362)
M12 (BGS 4363) - M14 (BGS 4364)
M16 - M18
- peso 2,2 kg



TORX® TORX® CON FORO 1/4"-1/2"
BGS
 articolo

DESCRIZIONE

2271
**SET 72 PEZZI,
 UTENSILI TORX ATT.
 1/4" + 1/2"**

CARATTERISTICHE

- bussole torx femmina:
 - att. 1/4": E4 - E5 - E6 - E7 - E8 - E10 - E11
 - att. 1/2": E12 - E14 - E16 - E18 - E20 - E22 - E24
- chiavi a bussola Torx, att. 1/4":
TX10 - TX15 - TX20 - TX25 - TX27 - TX30
- inserti att. 10 mm, lunghezza 30 mm, Torx c/ foro:
TH40 - TH45 - TH50 - TH55 - TH60 - TH70
- inserti att. 10 mm, lunghezza 75 mm, Torx: TX15
TX20 - TX25 - TX30 - TX40 - TX45 - TX50 - TX55 - TX60
- inserti att. 1/4", lunghezza 25 mm:
 - Torx: TX7 - TX8 - TX9
 - Torx con foro: TH10 - TH15 - TH20 - TH25 - TH27 - TH30 - TH40
- Chiave Torx tipo L: TX8 - TX10 - TX15 - TX20 - TX25
TX27 - TX30 - TX40 - TX45 - TX50 - TX55 - TX60
- cacciaviti Torx: TX8 - TX10 - TX15 - TX20 - TX25
TX27 - TX30 - TX40
- chiavi doppio anello: E6 x E8 - E10 x E12 - E14 x E18
E20 x E24
- adattatori
 - portainseriti esag. fem. 1/4" - quadro fem. 1/4"
 - portainseriti esag. fem. 10 mm - quadro fem. 1/2"
- utensile di raccolta magnetico



ADATTATORI DOPPIO QUADRO MASCHIO

articolo		L mm	
2841	1/4"	20	
3841	3/8"	30	
4841	1/2"	37	
BGS 9623	3/4"	53	
8841	1"	68	

CARATTERISTICHE

- con doppia sfera



SFERA



PROLUNGHE

attacco: 1/4"

articolo	L mm		
BGS 2336	50	1	
3738-0075	75	1	
BGS 2335	100	1	
BGS 2338	150	1	
BGS 9842	200	1	
BGS 2210	300	1	
BGS 2314	380	1	
BGS 2319	450	1	
BGS 2211	500	1	

TESTA
SFERICA

PROLUNGHE TESTA SFERICA

attacco: 1/4"

articolo	L mm		
BGS 2232	50	1	
BGS 2231	100	1	
BGS 2220	150	1	
BGS 9844	200	1	
BGS 2219	250	1	



 1/4" **PRO+**  1/4"

BGS articolo	DESCRIZIONE
BGS 2233	SET 3 PEZZI, PROLUNGHE

CARATTERISTICHE

- lunghezze: 50-150-250 mm
- acciaio al cromo vanadio
- finitura cromata satinata
- zigrinate
- testa sferica
- peso: 230 g



 1/4"  

BGS articolo	DESCRIZIONE
BGS 6110	SET 5 PEZZI, PROLUNGHE TESTA SFERICA, ATT. 1/4"

CARATTERISTICHE

- comprende le seguenti misure:
- att. 1/4", lunghezza: 50, 75, 100, 150, 225 mm;
- finitura cromata lucida
- in supporto in plastica
- peso: 280 g





 1/4"-3/8"-1/2"  

BGS articolo	DESCRIZIONE
BGS 6113	SET 9 PEZZI, PROLUNGHE TESTA SFERICA, ATT. 1/4" - 3/8" - 1/2"

CARATTERISTICHE

- comprende le seguenti misure:
- att. 1/4", lunghezza: 50, 100, 225 mm;
- att. 3/8", lunghezza: 75, 150, 225 mm;
- att. 1/2", lunghezza: 50, 125, 250 mm.
- finitura cromata lucida
- in supporto in plastica
- peso: 1,3 kg



 1/4"-3/8"-1/2" **PRO+** 

BGS articolo	DESCRIZIONE
BGS 2253	SET 9 PEZZI, PROLUNGHE TESTA SFERICA, ATT. 1/4" - 3/8" - 1/2"

CARATTERISTICHE

- comprende le seguenti misure:
- att. 1/4", lunghezza: 50 mm, 100 mm, 250 mm;
- att. 3/8", lunghezza: 75 mm, 150 mm, 250 mm;
- att. 1/2", lunghezza: 50 mm, 125 mm, 250 mm.
- peso: 1,8 kg

RICAMBI



BGS articolo	 1/4"	L mm
BGS 2232	1/4"	50
BGS 2231	1/4"	100
BGS 2219	1/4"	250
BGS 242	3/8"	75
BGS 243	3/8"	150
BGS 244	3/8"	250
BGS 233	1/2"	50
BGS 234	1/2"	125
BGS 235	1/2"	250

FLEX



 FEMMINA  MASCHIO

PROLUNGA FLESSIBILE MASCHIO - FEMMINA PER BUSSOLE

Koken articolo	 MASCHIO	 FEMMINA	L mm	
3741	1/4"	1/4"	145	1
2762-300	1/4"	1/4"	300	1

1/4"

FLEX



1/4" PRO+ CV 1/4"

BGS articolo BGS 2320	DESCRIZIONE PROLUNGA FLESSIBILE
---	--

CARATTERISTICHE
<ul style="list-style-type: none"> • lunghezza: 150 mm • peso: 70 g

FLEX



1/4" PRO+ CV 1/4"

BGS articolo BGS 2321	DESCRIZIONE PROLUNGA FLESSIBILE
---	--

CARATTERISTICHE
<ul style="list-style-type: none"> • lunghezza: 450 mm • peso: 150 g



SFERA

1/4" PRO+ CV 1/4"

BGS articolo BGS 250	DESCRIZIONE SNODO
--	------------------------------------

CARATTERISTICHE
<ul style="list-style-type: none"> • lunghezza: 35 mm • peso: 30 g



1/4"-3/8"-1/2" 1/4"-3/8"-1/2"

PRO+ CV

BGS articolo BGS 198	DESCRIZIONE SET 3 PEZZI, PROLUNGHE MAGNETICHE
--	--

CARATTERISTICHE
<ul style="list-style-type: none"> • per trattenere viti e bulloni nella bussola • peso: 400 g



1/4"-3/8"-1/2" 1/4"-3/8"-1/2"

PRO+ CV

BGS articolo BGS 252	DESCRIZIONE SET 3 PEZZI, SNODI CON MOLLA
--	---

CARATTERISTICHE
<ul style="list-style-type: none"> • cromati • peso: 280 g



SFERA

1/4"-3/8"-1/2"-3/4" 1/4"-3/8"-1/2"-3/4"

RACCORDI DI RIDUZIONE CHROM-VANADIUM

attacco: 1/4" - 3/8" - 1/2" - 3/4"

BGS articolo	FEMMINA	MASCHIO	
BGS 271	1/4"	3/8"	1
BGS 269	3/8"	1/4"	1
BGS 280	3/8"	1/2"	1
BGS 270	1/2"	3/8"	1
BGS 272	1/2"	3/4"	1
BGS 274	3/4"	1/2"	1





BGS articolo	DESCRIZIONE
BGS 199	SET 6 PEZZI, ADATTATORI

CARATTERISTICHE

- cromati satinati

CONTENUTO

- 1/4" F X 3/8" M, coppia massima 60 Nm
- 3/8" F X 1/4" M, coppia massima 60 Nm
- 3/8" F X 1/2" M, coppia massima 200 Nm
- 1/2" F X 3/8" M, coppia massima 200 Nm
- 1/2" F X 3/4" M, coppia massima 500 Nm
- 3/4" F X 1/2" M, coppia massima 500 Nm
- peso: 620 g









RICAMBI

BGS articolo	DESCRIZIONE
BGS 199-LEER	CASSETTA VUOTA



BGS articolo	DESCRIZIONE
BGS 8808	SET 4 PEZZI, RIDUZIONI

CARATTERISTICHE

- comprende 4 riduzioni:
 -  1/4" F -  3/8" M
 -  3/8" F -  1/4" M
 -  3/8" F -  1/2" M
 -  1/2" F -  3/8" M
- finitura cromata satinata
- peso: 140 g

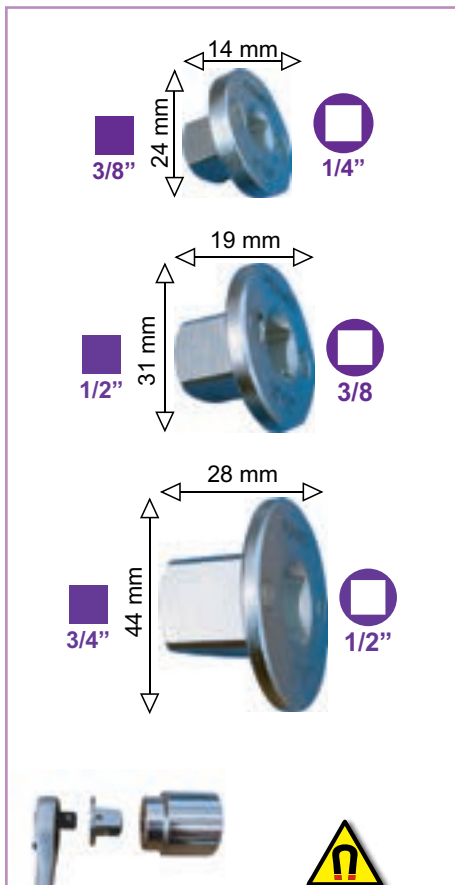

RACCORDI DI RIDUZIONE MAGNETICI A SCOMPARSA IDEALI PER CHIAVI DINAMOMETRICHE E SPAZI RIDOTTI

attacco: 1/4"-3/8"-1/2"

FERMEC articolo	FEMMINA	MASCHIO	
1434-1/4	1/4"	3/8"	1
1434-3/8	3/8"	1/2"	1
1434-1/2	1/2"	3/4"	1



RIDUZIONI A SCOMPARSA CON SFERA NEL QUADRO MASCHIO

Koken articolo	F	M	D mm	L mm	
2756 Z-3/8	1/4"	3/8"	20.3	21.5	1
2756 Z-1/2	1/4"	1/2"	20.3	26	1
3756 Z-1/2	3/8"	1/2"	28	29	1



RACCORDI DI RIDUZIONE MAGNETICI "POWER IMPACT" A SCOMPARSA - SPAZI RIDOTTI

FERMEC articolo	F	M	L mm	
698-00	1/4"	3/8"	17	1
698-0	1/4"	1/2"	22	1
698-1	3/8"	1/2"	22	1
698-11	1/2"	3/4"	30	1
698-8	3/4"	1"	35	1
698-13	1"	1 1/2"	50	1
698-15	1 1/2"	2 1/2"	60	1
698	CASSETTA 4 PZ. CONTENUTO: 1 PZ. 698-00 1 PZ. 698-1 1 PZ. 698-11 1 PZ. 698-8			1

1/4"



1/4" **PRO+** **CV**

DESCRIZIONE
BGS articolo BGS 276 ASTA CON QUADRO MASCHIO 1/4" SCORREVOLE

CARATTERISTICHE

- finitura cromata satinata
- lunghezza 115 mm
- peso: 60 g



1/4" **1/4"**

IMPUGNATURA PORTA BUSSOLE 1/4" QUADRO FEMMINA NELL'IMPUGNATURA

DESCRIZIONE
BGS articolo BGS 7825 IMPUGNATURA FLESSIBILE PORTA BUSSOLE

CARATTERISTICHE

- lunghezza 275 mm
- peso: 180 g



1/4" **PRO+** **CV**

DESCRIZIONE
BGS articolo BGS 216 IMPUGNATURA FINITURA CROMATA SATINATA

CARATTERISTICHE

- con impugnatura antiscivolo in materiale bi-componente
- lunghezza 150 mm
- peso: 80 g



1/4" **JAPAN**

IMPUGNATURE PORTA BUSSOLE

DESCRIZIONE
Koken articolo 2769 N-150 2769 N-220

CARATTERISTICHE

- ideale per lavorare in aree di difficile accesso
- adatto per le fascette stringitubo
- lama flessibile con doppia molla a spirale
- rivestimento in plastica per proteggere da umidità, sporco e ruggine
- materiale: acciaio al cromo vanadio (S2)
- tipo di impugnatura: ergonomica in materiale bi-componente
- lunghezza: 600 mm
- comprende:
 - 1 impugnatura flessibile 600 mm, esagonale, 7 mm
 - 1 impugnatura portainseri flessibile 600 m, att. esagonale 1/4"
 - 1 impugnatura portabussole flessibile 600 m, att. quadro 1/4"
 - inserti, lunghezza 25 mm, attacco esagonale 1/4":
 - Taglio: 5,5 mm (BGS 8199), 6,5 mm
 - PH: PH1 (BGS 8185), PH2 (BGS 8186)
 - Torx: TX10 (BGS 8190), TX15 (BGS 8191), TX20 (BGS 8192), TX25 (BGS 8193), TX27 (BGS 8194), TX30 (BGS 8195)
- peso: 1,3 kg



1/4" **JAPAN**

IMPUGNATURE A TESTA SFERICA PORTA BUSSOLE

DESCRIZIONE
Koken articolo 2769 NWF-150 2769 NWF-220

CARATTERISTICHE

- ideale per lavorare in aree di difficile accesso
- adatto per le fascette stringitubo
- lama flessibile con doppia molla a spirale
- rivestimento in plastica per proteggere da umidità, sporco e ruggine
- materiale: acciaio al cromo vanadio (S2)
- tipo di impugnatura: ergonomica in materiale bi-componente
- lunghezza: 600 mm
- comprende:
 - 1 impugnatura flessibile 600 mm, esagonale, 7 mm
 - 1 impugnatura portainseri flessibile 600 m, att. esagonale 1/4"
 - 1 impugnatura portabussole flessibile 600 m, att. quadro 1/4"
 - inserti, lunghezza 25 mm, attacco esagonale 1/4":
 - Taglio: 5,5 mm (BGS 8199), 6,5 mm
 - PH: PH1 (BGS 8185), PH2 (BGS 8186)
 - Torx: TX10 (BGS 8190), TX15 (BGS 8191), TX20 (BGS 8192), TX25 (BGS 8193), TX27 (BGS 8194), TX30 (BGS 8195)
- peso: 1,3 kg



FLEX
1/4"

IMPUGNATURE PORTA BUSSOLE FLESSIBILE

DESCRIZIONE
FERMEC articolo 3747

CARATTERISTICHE

- lunghezza 275 mm
- peso: 180 g

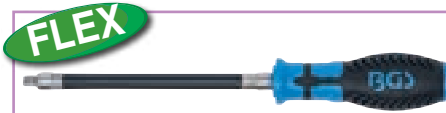

FLEX
1/4" **PRO+**

DESCRIZIONE
BGS articolo BGS 7825 IMPUGNATURA FLESSIBILE PORTA BUSSOLE

CARATTERISTICHE

- lunghezza 275 mm
- peso: 180 g



FLEX **novità**

1/4" 1/4" ESAGONO **CV S2** **PRO+**

DESCRIZIONE
BGS articolo BGS 74427 SET 13 PEZZI, CON CACCIAVITI FLESSIBILI EXTRA LUNGI

CARATTERISTICHE

- ideale per lavorare in aree di difficile accesso
- adatto per le fascette stringitubo
- lama flessibile con doppia molla a spirale
- rivestimento in plastica per proteggere da umidità, sporco e ruggine
- materiale: acciaio al cromo vanadio (S2)
- tipo di impugnatura: ergonomica in materiale bi-componente
- lunghezza: 600 mm
- comprende:
 - 1 impugnatura flessibile 600 mm, esagonale, 7 mm
 - 1 impugnatura portainseri flessibile 600 m, att. esagonale 1/4"
 - 1 impugnatura portabussole flessibile 600 m, att. quadro 1/4"
 - inserti, lunghezza 25 mm, attacco esagonale 1/4":
 - Taglio: 5,5 mm (BGS 8199), 6,5 mm
 - PH: PH1 (BGS 8185), PH2 (BGS 8186)
 - Torx: TX10 (BGS 8190), TX15 (BGS 8191), TX20 (BGS 8192), TX25 (BGS 8193), TX27 (BGS 8194), TX30 (BGS 8195)
- peso: 1,3 kg



FLEX
1/4" **PRO+**

DESCRIZIONE
BGS articolo BGS 7824 IMPUGNATURA FLESSIBILE, 500 MM

CARATTERISTICHE

- attacco 1/4"
- con 3 bussole da 4-5-7 mm
- peso: 410 g



1/4"

CHIAVE A "T" QUADRO MASCHIO SNODATA CROMATA ASTA SCORREVOLE CHROM-VANADIUM

DESCRIZIONE
FERMEC articolo 581-1/4

CARATTERISTICHE

- ideale per lavorare in aree di difficile accesso
- adatto per le fascette stringitubo
- lama flessibile con doppia molla a spirale
- rivestimento in plastica per proteggere da umidità, sporco e ruggine
- materiale: acciaio al cromo vanadio (S2)
- tipo di impugnatura: ergonomica in materiale bi-componente
- lunghezza: 600 mm
- comprende:
 - 1 impugnatura flessibile 600 mm, esagonale, 7 mm
 - 1 impugnatura portainseri flessibile 600 m, att. esagonale 1/4"
 - 1 impugnatura portabussole flessibile 600 m, att. quadro 1/4"
 - inserti, lunghezza 25 mm, attacco esagonale 1/4":
 - Taglio: 5,5 mm (BGS 8199), 6,5 mm
 - PH: PH1 (BGS 8185), PH2 (BGS 8186)
 - Torx: TX10 (BGS 8190), TX15 (BGS 8191), TX20 (BGS 8192), TX25 (BGS 8193), TX27 (BGS 8194), TX30 (BGS 8195)
- peso: 1,3 kg

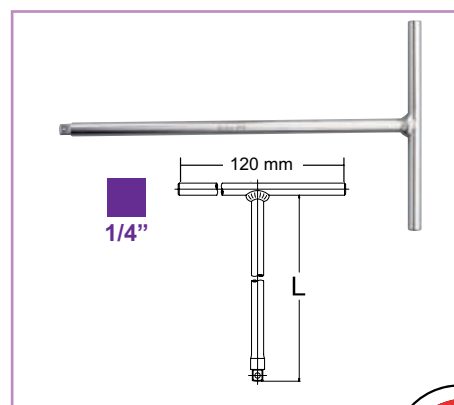

1/4" **JAPAN**

CHIAVI A "T" MASCHIO QUADRO 1/4" LARGHEZZA IMPUGNATURA 120 MM

DESCRIZIONE
Koken articolo 2715-1/4

CARATTERISTICHE

- ideale per lavorare in aree di difficile accesso
- adatto per le fascette stringitubo
- lama flessibile con doppia molla a spirale
- rivestimento in plastica per proteggere da umidità, sporco e ruggine
- materiale: acciaio al cromo vanadio (S2)
- tipo di impugnatura: ergonomica in materiale bi-componente
- lunghezza: 600 mm
- comprende:
 - 1 impugnatura flessibile 600 mm, esagonale, 7 mm
 - 1 impugnatura portainseri flessibile 600 m, att. esagonale 1/4"
 - 1 impugnatura portabussole flessibile 600 m, att. quadro 1/4"
 - inserti, lunghezza 25 mm, attacco esagonale 1/4":
 - Taglio: 5,5 mm (BGS 8199), 6,5 mm
 - PH: PH1 (BGS 8185), PH2 (BGS 8186)
 - Torx: TX10 (BGS 8190), TX15 (BGS 8191), TX20 (BGS 8192), TX25 (BGS 8193), TX27 (BGS 8194), TX30 (BGS 8195)
- peso: 1,3 kg



1/4" PRO+ CV

BGS articolo	DESCRIZIONE		
BGS 7800	IMPUGNATURA A T, CON QUADRO MASCHIO DA 1/4", LUNGHEZZA 230 MM		

CARATTERISTICHE

- impugnatura ergonomica
- finitura satinata cromata
- lunghezza:
 - totale: 230
 - lama: 180
- peso: 150 g



CRICCHETTO REVERSIBILE CON QUADRO FEMMINA PASSANTE

FERMEC articolo		L mm
BGS 9160	1/4"	115
BGS 312	1/2"	270
BGS 9622	3/4"	500

CARATTERISTICHE

- quadro passante
- impugnatura rivestita



1/4"

CRICCHETTO REVERSIBILE PORTA BUSSOLE 1/4" CON IMPUGNATURA A MANOPOLA PALMARE E PULSANTE DI SGANCIO

attacco: 1/4"

FERMEC articolo		L mm	
15116	1/4"	25	1



LUNGHEZZA SOLO 90 MM

1/4"

MINI CRICCHETTO REVERSIBILE, ATT. 1/4", LUNGH. 90MM, CON PULSANTE DI SGANCIO RAPIDO

attacco: 1/4"

FERMEC articolo		L mm	
15133	1/4"	90	1



1/4" PRO+ CV

BGS articolo	DESCRIZIONE		
BGS 618	CRICCHETTO REVERSIBILE, ATT. 1/4", LUNGH. 150 MM		

CARATTERISTICHE

- modello dritto
- cricchetto reversibile 72 denti
- con pulsante di sgancio rapido
- impugnatura in materiale bi-componente
- finitura: cromato satinato
- lunghezza: 150 mm
- peso: 140 g



1/4"

BGS articolo	DESCRIZIONE		
BGS 221	CRICCHETTO ATT. 1/4", LUNGH. 140 MM "KRAFTMANN"		

CARATTERISTICHE

- reversibile
- con impugnatura ergonomica in gomma
- lunghezza: 140 mm
- peso: 160 g



1/4"

NUOVO CRICCHETTO REVERSIBILE A 72 DENTI CON PULSANTE DI SBLOCCAGGIO DELLA BUSSOLE ED IMPUGNATURA ERGONOMICA BICOMPONENTE ANTISCIVOLO E FORMA OVALE

FERMEC articolo		L mm	
572	1/4"	130	1



novità

1/4" CV PRO+

BGS articolo	DESCRIZIONE		
BGS 630	CRICCHETTO REVERSIBILE, ATT. 1/4", LUNGH. 155 MM, 90 DENTI		

CARATTERISTICHE

- cricchetto reversibile 90 denti
- con pulsante di sgancio rapido
- impugnatura in materiale bi-componente
- finitura: cromata satinata
- lunghezza: 155 mm
- peso: 170 g



1/4" CV

BGS articolo	DESCRIZIONE		
BGS 517	CRICCHETTO REVERSIBILE, ATT. 1/4", LUNGH. 160 MM, 72 DENTI		

CARATTERISTICHE

- impugnatura in materiale bi-componente
- con sgancio rapido
- lunghezza: 160 mm
- peso: 150 g

CARATTERISTICHE

- impugnatura in materiale bi-componente
- con sgancio rapido
- lunghezza: 160 mm
- peso: 150 g



72 DENTI

1/4" PRO+ CV

BGS articolo	DESCRIZIONE		
BGS 302	CRICCHETTO IN NYLON E FIBRA DI VETRO, ATT. 1/4", LUNGH. 155 MM		

CARATTERISTICHE

- comodo utilizzo grazie ai materiali ultra-leggeri, nessun affaticamento
- capacità massima decisamente superiori ai limiti DIN
- in polipropilene rivestito in acciaio CR-V con impugnatura in materiale bi-componente
- lunghezza: 155 mm
- peso 120 g

RICAMBI

BGS articolo	DESCRIZIONE		
BGS 302-1	novità SET RIPARAZIONE CRICCHETTO		

BGS
articolo

DESCRIZIONE

BGS 622

CRICCHETTO REVERSIBILE, ATT. 1/4", LUNGH. 110 MM., EXTRA CORTO

CARATTERISTICHE

- modello extra corto
- cricchetto reversibile 72 denti
- con pulsante di sgancio rapido
- impugnatura in materiale bi-componente
- finitura: cromato satinato
- lunghezza: 110 mm
- peso: 120 g

BGS
articolo

DESCRIZIONE

BGS 642

MINI-CRICCHETTO REVERSIBILE, ATT. 1/4", LUNGH. 110 MM., EXTRA CORTO

CARATTERISTICHE

- design compatto
- reversibile
- con pulsante di sgancio rapido
- attacco quadro maschio: 1/4"
- numero di denti testa del cricchetto: 90
- impugnatura in materiale bi-componente
- materiale: acciaio al cromo vanadio
- finitura: cromata satinata
- lunghezza: 110 mm
- peso: 150 g



BGS 9161

1/4" CV

BGS
articolo

DESCRIZIONE

BGS 9160

CRICCHETTO PASSANTE, ATT. QUADRO FEMMINA 1/4", LUNGH. 115 MM

CARATTERISTICHE

- 30 denti
- cromato satinato
- impugnatura in materiale bi-componente
- lunghezza: 115 mm
- peso: 90 g

RICAMBI

BGS
articolo

DESCRIZIONE

BGS 9161

ADATTATORE DOPPIO QUADRO 1/4"

BGS
articolo

DESCRIZIONE

BGS 610

CRICCHETTO REVERSIBILE, ATT. 1/4", LUNGH. 135 MM "EXTRA SLIM"

CARATTERISTICHE

- cricchetto reversibile 72 denti
- modello dritto "extra slim"
- con pulsante di sgancio rapido
- acciaio al Cromo Vanadio
- lunghezza: 135 mm
- impugnatura in materiale bi-componente
- peso: 100 g

QUANDO MANCA LO SPAZIO

novità



1/4" CV

BGS
articolo

DESCRIZIONE

BGS 105

CRICCHETTO REVERSIBILE, AD IMPUGNATURA ROTATIVA, ATT. 1/4", LUNGH. 185 MM

CARATTERISTICHE

- dentatura fine
- reversibile
- doppia funzione:
 - ruotando l'impugnatura si ottiene un movimento rotatorio del quadro
 - azione a "cricchetto tradizionale"
- attacco quadro maschio: 1/4"
- impugnatura ergonomica
- materiale: acciaio al cromo vanadio
- finitura: cromata satinata
- lunghezza: 185 mm
- larghezza: 28 mm
- peso: 200 g



1/4"

CRICCHETTO REVERSIBILE 72 DENTI SNODATO CON PULSANTE DI BLOCCAGGIO BUSSOLA (RICAMBIO CASSETTA ART. 21492)

attacco: 1/4"

articolo	L mm	
3748	135	1

TESTA SNODATA



MECCANISMO 72 DENTI

1/4" PRO+

BGS articolo	DESCRIZIONE
BGS 112	CRICCHETTO ATT. 1/4", LUNGH. 160 MM, CON TESTA SNODATA REGOLABILE

CARATTERISTICHE

- testa snodata 180°
- finitura cromata
- cricchetto reversibile 72 denti
- con pulsante di sgancio rapido
- lunghezza 160 mm
- peso: 150 g



1/4" PRO+ CV

BGS articolo	DESCRIZIONE
BGS 2126	CRICCHETTO SNODATO ATT. 1/4", LUNGH. 450 MM, CON IMPUGNATURA A "T"

CARATTERISTICHE

- finitura cromata
- lunghezza 450 mm
- peso: 390 g

MECCANISMO 45 DENTI



1/4" PRO+ CV

BGS articolo	DESCRIZIONE
BGS 285	CRICCHETTO ATT. 1/4", LUNGH. 160 MM, CON TESTA SNODATA REGOLABILE

CARATTERISTICHE

- finitura satinata cromata
- regolabili in sicurezza in 5 posizioni
- 45 denti
- con pulsante di sgancio rapido
- impugnatura con occhiello
- lunghezza 160 mm
- peso: 170 g

novità



3 IN 1

1/4" 3/8" 1/2" PRO+ CV

BGS articolo	DESCRIZIONE
BGS 71015	CRICCHETTO REVERSIBILE, DENTE FINE, 3 IN 1, 1/4" / 3/8" / 1/2"

CARATTERISTICHE

- in acciaio
- per bussole con attacco quadro 1/4", 3/8", 1/2"
- 72 denti
- tutti gli attacchi integrati in un unico profilo quadrato di uscita
- con leva di inversione
- materiale: acciaio al carbonio
- finitura: lucidatura a specchio
- lunghezza: 190 mm
- peso: 360 g

novità



ESTENSIBILI & SNODATI

1/4" 3/8" 1/2" PRO+ CV

CRICCHETTI REVERSIBILI ESTENSIBILI, SNODATI

BGS articolo	DESC	DESCRIZIONE
BGS 25125	1/4"	210 - 250 MM
BGS 25126	3/8"	260 - 365 MM
BGS 25127	1/2"	350 - 490 MM

CARATTERISTICHE

- leva lunga estensibile e snodata
- bloccabile in varie posizioni mediante un anello autobloccante
- con pulsante di sgancio rapido
- impugnatura in materiale bi-componente antiscivolo ed ergonomica
- cricchetti reversibili 72 denti, snodati 180°
- attacco quadro
- materiale: acciaio al cromo vanadio
- finitura: cromata satinata

novità



ESTENSIBILI

1/4" 3/8" 1/2" CV PRO+

CRICCHETTI REVERSIBILI ESTENSIBILI

BGS articolo	DESC	DESCRIZIONE
BGS 25120	1/4"	190 - 225 MM
BGS 25121	3/8"	240 - 345 MM
BGS 25122	1/2"	305 - 445 MM

CARATTERISTICHE

- leva lunga estensibile e snodata
- bloccabile in varie posizioni mediante un anello autobloccante
- con pulsante di sgancio rapido
- impugnatura in materiale bi-componente antiscivolo ed ergonomica
- cricchetti reversibili 72 denti
- attacco quadro
- materiale: acciaio al cromo vanadio
- finitura: cromata satinata



novità

EXTRA-LUNGHE



BGS 635-REPAIR BGS 636-REPAIR BGS 637-REPAIR

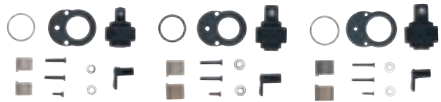

CRICCHETTI REVERSIBILI, EXTRA LUNGHI

BGS articolo	LUNGHEZZA mm
BGS 635	300
BGS 636	455
BGS 637	605

CARATTERISTICHE

- sforzo ridotto grazie alla leva più lunga
- dritte
- 72 denti
- con pulsante di sgancio rapido
- con cricchetto reversibile
- attacco quadro maschio
- impugnatura in materiale bi-componente
- materiale: acciaio al cromo vanadio
- finitura: cromato satinato

RICAMBI

BGS articolo	DESCRIZIONE
BGS 635-REPAIR	PER BGS 635 & BGS 638
BGS 636-REPAIR	PER BGS 636 & BGS 639
BGS 637-REPAIR	PER BGS 637 & BGS 640



novità

SNODATE



BGS 635-REPAIR BGS 636-REPAIR BGS 637-REPAIR



CRICCHETTI REVERSIBILI, EXTRA LUNGHI

BGS articolo	LUNGHEZZA mm
BGS 638	304
BGS 639	457
BGS 640	609

CARATTERISTICHE

- testa a cricchetto snodata 180°
- sforzo ridotto grazie alla leva più lunga
- dritte
- 72 denti
- con pulsante di sgancio rapido
- con cricchetto reversibile
- attacco quadro maschio
- impugnatura in materiale bi-componente
- materiale: acciaio al cromo vanadio
- finitura: cromato satinato

RICAMBI

BGS articolo	DESCRIZIONE
BGS 635-REPAIR	PER BGS 635 & BGS 638
BGS 636-REPAIR	PER BGS 636 & BGS 639
BGS 637-REPAIR	PER BGS 637 & BGS 640



novità

ESTENSIBILI & SNODATI



BGS articolo	DESCRIZIONE
BGS 25128	SET 3 PEZZI, CRICCHETTI REVERSIBILI ESTENSIBILI, SNODATI, ATTACCO 1/4" - 3/8" - 1/2"

CARATTERISTICHE

- leva lunga estensibile e snodata
- bloccabile in varie posizioni mediante un anello autobloccante
- con pulsante di sgancio rapido
- impugnatura in materiale bi-componente antiscivolo ed ergonomica
- cricchetti reversibili 72 denti, snodati 180°
- attacco quadro
- materiale: acciaio al cromo vanadio
- finitura: cromata satinata
- comprende:
 - 1 cricchetto reversibile, estensibile, snodato, attacco 1/4", 210 - 250 mm (BGS 25125)
 - 1 cricchetto reversibile, estensibile, snodato, attacco 3/8", 260 - 365 mm (BGS 25126)
 - 1 cricchetto reversibile, estensibile, snodato, attacco 1/2", 350 - 490 mm (BGS 25127)
- peso 2,7 kg



novità

ESTENSIBILI

1/4" 3/8" 1/2" **CV** PRO+

BGS articolo	DESCRIZIONE
BGS 25123	SET 3 PEZZI, CRICCHETTI REVERSIBILI ESTENSIBILI, ATTACCO 1/4" - 3/8" - 1/2"

CARATTERISTICHE

- leva lunga estensibile e snodata
- bloccabile in varie posizioni mediante un anello autobloccante
- con pulsante di sgancio rapido
- impugnatura in materiale bi-componente antiscivolo ed ergonomica
- cricchetti reversibili 72 denti
- attacco quadro
- materiale: acciaio al cromo vanadio
- finitura: cromata satinata
- comprende:
 - 1 cricchetto reversibile, estensibile, attacco 1/4", 190 - 225 mm (BGS 25120)
 - 1 cricchetto reversibile, estensibile, attacco 3/8", 240 - 345 mm (BGS 25121)
 - 1 cricchetto reversibile, estensibile, attacco 1/2", 305 - 445 mm (BGS 25122)
- peso 2,5 kg



novità

ESTENSIBILI

1/4" 3/8" 1/2"

BGS articolo	DESCRIZIONE
BGS 72113	SET 3 PEZZI, CRICCHETTI REVERSIBILI ESTENSIBILI, ATTACCO 1/4" - 3/8" - 1/2"

CARATTERISTICHE

- braccio di leva lungo e telescopico per applicare facilmente coppie elevate
- bloccabile in varie fasi mediante anello autoserrante
- con sgancio rapido
- impugnatura in materiale bi-componente antiscivolo ed ergonomica
- 72 denti
- cricchetti reversibili con leva di inversione
- quadro con sfera di bloccaggio
- materiale: acciaio al cromo vanadio
- finitura: cromata satinata
- comprende:
 - 1 cricchetto reversibile estensibile, attacco 1/4", regolabile in 4 lunghezze, lunghezza massima 200 mm
 - 1 cricchetto reversibile estensibile, attacco 3/8", regolabile in 5 lunghezze, lunghezza massima 320 mm
 - 1 cricchetto reversibile estensibile, attacco 1/2", regolabile in 6 lunghezze, lunghezza massima 445 mm
- peso: 2,7 kg



novità

KIT DI RIPARAZIONE PER TESTA A CRICCHETTO

BGS articolo	
BGS 72115	1/4"
BGS 72116	3/8"
BGS 72117	1/2"

CARATTERISTICHE

- tutte le parti di usura per la testa del cricchetto in un unico set
- per BGS 72113



MECCANISMO 72 DENTI

1/4"-3/8"-1/2"

PRO+ **CV**

BGS articolo	DESCRIZIONE
BGS 215	SET 3 PEZZI, CRICCHETTI REVERSIBILI COMPATTI 1/4"-3/8"-1/2"

CARATTERISTICHE

- formato extra-small per spazi ridotti e angusti
- 72 denti
- lunghezza cricchetti:
 - attacco 1/4": 110 mm
 - attacco 3/8": 170 mm
 - attacco 1/2": 140 mm
- peso: 1,2 kg

SET 1/4"



BGS 618 **BGS 618-1**

BGS 619 **BGS 619-1**

BGS 620 **BGS 620-1**

1/4"-3/8"-1/2" **CV** **PRO+**

BGS articolo	DESCRIZIONE
BGS 621	SET 3 PEZZI, CRICCHETTI REVERIBILI, 1/4"-3/8"-1/2"

CARATTERISTICHE

- impugnatura ergonomica antiscivolo in materiale bi-componente
- stelo sfasato
- con pulsante di sgancio rapido
- cricchetto reversibile 72 denti
- lunghezza:
 - cricchetto reversibile attacco 1/4" (BGS 618): 150 mm
 - cricchetto reversibile attacco 3/8" (BGS 619): 200 mm
 - cricchetto reversibile attacco 1/2" (BGS 620): 250 mm
- peso: 1,4 kg

RICAMBI	
BGS articolo	DESCRIZIONE
BGS 618	CRICCHETTO REVERIBILE, ATTACCO 1/4"
BGS 618-1	SET RIPARAZIONE CRICCHETTO, ATTACCO 1/4"
BGS 619	CRICCHETTO REVERIBILE, ATTACCO 3/8"
BGS 619-1	SET RIPARAZIONE CRICCHETTO, ATTACCO 3/8"
BGS 620	CRICCHETTO REVERIBILE, ATTACCO 1/2"
BGS 620-1	SET RIPARAZIONE CRICCHETTO, ATTACCO 1/2"



BGS 15105

DESCRIZIONE

SET 27 PEZZI, BUSSOLE E CRICCHETTO, ATT. 1/4"

CARATTERISTICHE

- chiave a cricchetto reversibile da 1/4"
- 12 bussole Esagonali, attacco da 1/4": 4 - 4,5 - 5 - 5,5 - 6 - 7 - 8 - 9 - 10 - 11 - 12 - 13 mm
- 14 chiavi a bussola, attacco da 1/4":
 - TX 10 - 15 - 20 - 25 - 30
 - PH 1 - 2
 - Taglio 4 - 5,5 - 7 mm
 - Esagono 3 - 4 - 5 - 6 mm
- peso: 610 g



CASSETTA 13 BUSSOLE ESAGONALI ATT. 1/4"

- 4-4,5-5-5,5-6-7-8-9-10-11-12-13-14 MM
- 3 PROLUNGHE 1/4" LUNGH. 50-100-150 MM
- 1 CRICCHETTO A MANOPOLA CON PULSANTE DI BLOCCAGGIO

attacco: 1/4"
impronta: ESAGONALE

FEARMEC articolo	Descrizione	
21717	CASSETTA PLASTICA 17 PEZZI	1
15116	RICAMBIO CRICCHETTO A MANOPOLA	1

POLLICI



BGS 2246

DESCRIZIONE

SET 23 PEZZI, BUSSOLE ESAGONALI IN POLLICI, ATT. 1/4" - 1/2"

CARATTERISTICHE

- bussole esagonali attacco 1/4": 5/32", 3/16", 7/32", 1/4", 9/32", 5/16", 11/32", 3/8", 7/16", 15/32"
- bussole esagonali attacco 1/2": 1/2", 9/16", 19/32", 5/8", 11/16", 3/4", 13/16", 7/8", 15/16", 1", 1-1/16", 1-1/8", 1-1/4"
- finitura satinata cromata
- zigrinate
- peso: 2,2 kg



novità



BGS articolo	DESCRIZIONE
BGS 92146	SET 130 PEZZI, BUSSOLE E INSERTI ATT. 1/4"

CARATTERISTICHE

- in valigetta in plastica
- materiale: acciaio al cromo vanadio
- finitura: cromata satinata
- comprende:
 - 1 cricchetto reversibile, att. 1/4" (BGS 517)
 - chiavi di tipo L, Esagonali: 1,27 - 1,5 - 2 - 2,5 - 3 - 4 - 5 mm
 - inserti att. 1/4":
 - PH: PH0 (2 PEZZI) - PH1 (2 PEZZI) - PH2 (4 PEZZI) - PH3 (2 PEZZI)
 - PZ: PZ0 (2 PEZZI) - PZ1 (2 PEZZI) - PZ2 (4 PEZZI) - PZ3 (2 PEZZI)
 - Taglio: 3 - 4 - 4,5 - 5 - 5,5 - 6 - 6,5 - 7 - 8 mm
 - Torx: TX8 - 1 TX10 - TX15 - TX20 - TX25 - TX27 - TX30 - TX35 - TX40 - TX45
 - Esagonali, in pollici: 1/16" - 5/64" - 3/32" - 7/46" - 1/8" - 9/64" - 5/32" - 3/16" - 7/32" - 1/4"
 - Esagonali: 1,5 - 2 - 2,5 - 3 - 4 - 5 - 5,5 - 6 - 8 mm
 - Quadro maschio: S0 - S1 - S2 - S3
 - Torq-set: 6 - 8 - 10
 - XZN: M5 - M6 - M8
 - Torx c/foro: TH8 - TH10 - TH15 - TH20 - TH25 - TH27 - TH30 - TH35 - TH40
 - Clutch: C1 - C2 - C3
 - Esagonali c/foro, in pollici: 5/64" - 3/32" - 7/64" - 1/8" - 9/64" - 5/32"
 - Spanner: 4 - 6 - 8 - 10 mm
 - Tri-Wing: 1 - 2 - 3 - 4
 - Esagonali c/foro: 2 mm - 2,5 mm - 3 mm - 4 mm - 5 mm - 6 mm
 - PH, lunghezza 50 mm: PH1 - PH2
 - PZ, lunghezza 50 mm: PZ1 - PZ2
 - inserto per occhielli
 - 1 impugnatura, att. 1/4", lunghezza 150 mm
 - 1 leva con quadro scorrevole, att. 1/4"
 - 1 prolunga, att. 1/4": 50 mm
 - 1 adattatore portainseri att. 1/4" - quadro femmina 1/4"
 - bussole, att. 1/4", esagonali: 4 - 4,5 - 5 - 5,5 - 6 - 7 - 8 - 9 - 10 - 11 - 12 - 13 - 14 mm
- peso 1,5 kg



BUSSOLE ESAGONALI



BGS articolo	DESCRIZIONE
BGS 2289	SET 92 PEZZI, BUSSOLE E ACCESSORI ATT. 1/4" - 3/8"

CARATTERISTICHE

- comprende i seguenti utensili attacco 1/4":
 - cricchetto reversibile 72 denti
 - bussole esagonali: 4 - 4,5 - 5 - 6 - 7 - 8 - 9 - 10 - 11 - 13 mm
 - bussole esagonali lunghe: 6 - 8 - 10 - 11 - 13 mm
 - 1 adattatore portainseri
 - 1 impugnatura 150 mm
 - 1 snodo
 - 1 prolunga
 - 1 leva con quadro scorrevole
- comprende i seguenti utensili attacco 3/8":
 - cricchetto reversibile 72 denti
 - bussole esagonali: 14 - 15 - 16 - 17 - 19 - 20 - 21 - 22 - 23 - 24 mm
 - bussole esagonali lunghe: 14 - 16 - 17 - 19 mm
 - 1 adattatore portainseri
 - 1 snodo
 - 1 prolunga
 - 3 bussole per candele: 16 - 18 - 21 mm
 - 1 riduzione quadro 3/8" Femmina - quadro 1/4" Maschio
- 29 inserti (S2):
 - Taglio: 2 - 2,5 - 3 - 4 - 5 - 6 - 7 mm
 - PH: PH0, PH1, PH2, PH3
 - PZ: PZ0, PZ1, PZ2, PZ3
 - Esagonali: 1,5 - 2 - 2,5 - 3 - 4 - 5 - 7 mm
 - Torx: TX10 - TX15 - TX20 - TX25 - TX27 - TX30 - TX40
- 9 chiavi combinate: 6 - 8 - 10 - 11 - 13 - 14 - 16 - 17 - 19 mm
- 9 chiavi a L esagonali: 1,5 - 2 - 2,5 - 3 - 4 - 5 - 6 - 8 - 10 mm
- peso: 5,6 kg



BGS articolo	DESCRIZIONE
BGS 20123	SET 23 PEZZI, BUSSOLE E INSERTI ATT. 1/4"

CARATTERISTICHE

- in cassetta in plastica
- comprende:
 - 1 portainseri magnetico, attacco esagonale 1/4"
 - 3 inserti attacco 1/4" PH: PH0 - PH1 - PH2
 - 5 inserti attacco 1/4" Taglio: 3 - 4 - 5 - 6 - 7 mm
 - 4 inserti attacco 1/4", Torx: TX10-TX15-TX20-TX30
 - 1 cricchetto reversibile attacco esagono femmina 1/4"
 - 9 bussole esagonali, attacco 1/4", misure: 5 - 6 - 7 - 8 - 9 - 10 - 11 - 12 mm
 - 1 adattatore portabussole attacco esagonale 1/4" - quadro maschio 1/4", lunghezza 25 mm
- peso: 390 g

POLLICI



CASSETTA 46 CHIAVI A BUSSOLA ESAGONALI 1/4" - IN POLLICI



BGS articolo	DESCRIZIONE	
21532	SET 46 PEZZI, BUSSOLE ATT. 1/4"	1

CARATTERISTICHE

- bussole: 5/32", 3/16", 7/32", 1/4", 9/32", 5/16", 11/32", 3/8", 13/32", 7/16", 15/32", 1/2", 9/16"
- chiave a cricco 1/4" con pulsante di sgancio + inserti

SET 1/4"



1/4"

BGS
articolo

DESCRIZIONE

BGS 2142

**SET 46 PEZZI,
BUSSOLE ATT. 1/4"**

CARATTERISTICHE

- bussole surface drive da 4 a 13 mm
- completo di chiavi a bussola taglio, PH, esagonali e Torx in diversi formati
- realizzate in conformità con le norme DIN
- cricchetto reversibile 72 denti con impugnatura in materiale bi-componente
- in cromo vanadio
- peso: 1,4 kg



1/4"



PRO+

BGS
articolo

DESCRIZIONE

BGS 2147

**SET 52 PEZZI,
BUSSOLE ATT. 1/4"**

CARATTERISTICHE

- durezza e coppia in conformità con DIN
- bussole con finitura Esagonale
- 1 chiave a cricchetto reversibile da 1/4" con pulsante di sgancio rapido (BGS 630)
- 1 barra scorrevole a T (BGS 276)
- 1 snodo (BGS 250)
- 1 impugnatura attacco quadro 150 mm (BGS 216)
- 2 barre di prolunga: 50 mm (BGS 2336), 100 mm (BGS 2335)
- 3 chiavi tipo L 1,5 - 3 mm
- 18 chiavi a bussola attacco da 1/4":
 - PH: PH1 (BGS 2487), PH2 (BGS 2488), PH3 (BGS 2489)
 - Taglio: 4 mm (BGS 2493), 5,5 mm (BGS 2494), 6,5 mm (BGS 2495)
 - Esagonale: 3 mm (BGS 2497), 4 mm (BGS 2498), 5 mm (BGS 2499), 6 mm (BGS 2500), 7 mm (BGS 2501), 8 mm (BGS 2502)
 - Torx con Foro: TH10 (BGS 2357), TH15 (BGS 2358), TH20 (BGS 2359), TH25 (BGS 2360), TH30 (BGS 2362), TH40 (BGS 2363)
- 13 bussole attacco da 1/4": 4 mm (BGS 2474), 4,5 mm (BGS 2475), 5 mm (BGS 2476), 5,5 mm (BGS 2477), 6 mm (BGS 2478), 7 mm (BGS 2479), 8 mm (BGS 2480), 9 mm (BGS 2481), 10 mm (BGS 2482), 11 mm (BGS 2483), 12 mm (BGS 2484), 13 mm (BGS 2485), 14 mm (BGS 2486)
- 6 bussole lunghe attacco da 1/4": 8 mm (BGS 10508), 10 mm (BGS 10510), 11 mm (BGS 10511), 12 mm (BGS 10512), 13 mm (BGS 10513), 14 mm (BGS 10514)
- 7 bussole Torx attacco da 1/4": E4 (BGS 6404), E5 (BGS 6405), E6 (BGS 6406), E7 (BGS 6407), E8 (BGS 6408), E10 (BGS 6430), E11 (BGS 6431)
- peso: 1,6 kg

RICAMBI

BGS
articolo

DESCRIZIONE

BGS 2147-LEER

CASSETTA VUOTA

1/4"



PRO+

BGS
articolo

DESCRIZIONE

BGS 2144

**SET 46 PEZZI,
BUSSOLE ATT. 1/4"**

CARATTERISTICHE

- bussole e barre di prolunga con zigrinatura a spirale
- barre di prolunga con esagono
- 1 chiave a cricchetto reversibile da 1/4" con pulsante di sgancio rapido
- 1 snodo
- 3 chiavi tipo L
- 1 adattatore inserto
- 1 impugnatura quadro
- 3 barre di prolunga da 1/4"
- 12 bussole attacco da 1/4" 4-13 mm
- 24 inserti da 1/4": Phillips, Taglio, PZ, Torx c/foro, Esagono
- peso: 1,1 kg



BGS articolo	DESCRIZIONE
BGS 2146	SET 46 PEZZI, BUSSOLE ATT. 1/4"

CARATTERISTICHE

• **chiavi a bussola Torx c/foro**

• contenuto:

- 1 adattatore 1/4" esagonale x 1/4" quadrato
- 1 impugnatura attacco quadro
- 2 barre di prolunga 50 + 100 mm
- 1 snodo
- 1 barra scorrevole a T
- 1 barra di prolunga flessibile
- 1 chiave a cricchetto reversibile con pulsante di sgancio rapido
- 3 chiavi tipo L Esagono: 1,5 - 2 - 3 mm
- 6 chiavi a bussola Torx c/ foro attacco 1/4": Th10-Th15-Th20-Th25- Th30-Th40
- 11 chiavi a bussola attacco da 1/4": Taglio, PH, PZ, Esagono
- 13 bussole "surface drive" attacco 1/4": 4-4,5-5-5,5-6-7-8-9-10-11-12-13-14 mm

• peso: 1,3 kg

RICAMBI

BGS articolo	DESCRIZIONE
BGS 2146-LEER	CASSETTA VUOTA



SET INSERTI E BUSSOLE MULTIMPRONTA DA 5 A 13 MM CON MINI CRICCHETTO REVERSIBILE E PROLUNGA L. 50 MM

attacco: 1/4"
impronta: Spline drive

FERMEC articolo	Descrizione	
BIT-33	BOX PLASTICA	1



MULTIMPRONTA SPLINE DRIVE

CASSETTA BUSSOLE MULTIMPRONTA ATTACCO 1/4" ADATTE PER DADI ESAGONALI POLIGONALI - POLLICI - QUADRI - XZN® - TORX® - PEZZI 30 DA 4-14 MM

FERMEC articolo	Descrizione	
FRM 4205	VALIGETTA 30 PEZZI	1

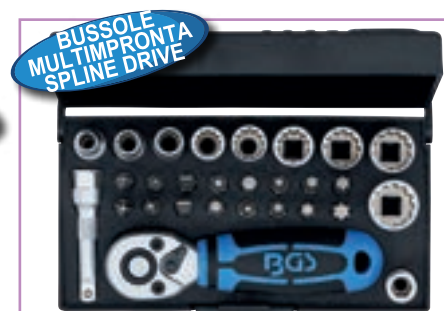

BGS articolo	DESCRIZIONE
BGS 2143	SET 28 PEZZI, BUSSOLE MULTIMPRONTA ATT. 1/4"

CARATTERISTICHE

- 1 chiave a cricchetto a 72 denti (extra-corto - lunghezza 108 mm)
- 1 barra di prolunga da 1/4" 50 mm
- 1 portainseriti
- 9 bussole "multimpronta": 5-6-7-8-9-10-11-12-13 mm
- La testa Multimpronta si adatta a dadi esagonali, a 12 punti, metrici + in pollici, Torx
- 16 inserti da 1/4" acciaio S2: PH no. 1+2 ; PZ no. 1+2; Taglio 4,5+6 mm Esagono 3+4+5 mm Torx TX10-15-20-25-27-30-40
- peso: 450 g

RICAMBI

BGS articolo	DESCRIZIONE
BGS 2143-LEER	CASSETTA VUOTA



- 6 BUSSOLE TORX® 1/4" - E 4-5-6-7-8-10
- 7 BUSSOLE CON INSERTI TORX® TX 10-15-20-25-27-30-40
- 1 ADATTATORE F. 3/8" - M. 1/4"

attacco: 1/4"
impronta: TORX®

FERMEC articolo	Descrizione	
3765	CASSETTA METALLICA 14 PEZZI	1



1/4"-3/8" ESAGONO 5/16" C TORX® CON FORO



BGS articolo	DESCRIZIONE
BGS 5023	SET 17 PEZZI, BUSSOLE E INSERTI TORX, ATT. 1/4" - 3/8"

- CARATTERISTICHE**
- bussole
 - attacco 1/4": E 6-7-8
 - attacco 3/8": E 10-12-14-16
 - 9 inserti Torx c/foro attacco esagonale 5/16": TH 10-15-20-25-30-40-45-50-55
 - adattatore portainseri attacco quadro 3/8" x 5/16" esagonale
 - peso: 500 g

RICAMBI	
BGS articolo	DESCRIZIONE
BGS 5023-LEER	CASSETTA VUOTA



1/4" 3/8" 1/2" TORX® PRO+

BGS articolo	DESCRIZIONE
BGS 70099	SET 28 PEZZI, BUSSOLE TORX FEMMINA, E4 - E20, ATT. 1/4" - 3/8" - 1/2"

- CARATTERISTICHE**
- zigrinato
 - finitura cromata satinata
 - impronta Torx Femmina
 - comprende:
 - attacco 1/4": E4 - E5 - E6 - E7 - E8 - E10 - E11
 - attacco 3/8": E4 - E5 - E6 - E7 - E8 - E10 - E11 E12 - E14 - E16 - E18 - E20
 - attacco 1/2": E4 - E5 - E6 - E7 - E8 - E10 - E11 E12 - E14 - E16 - E18 - E20
 - peso: 1,3 kg

TORX®	S mm	S mm	
E 4	3.70	E 16	14.60
E 5	4.60	E 18	16.50
E 6	5.60	E 20	18.30
E 7	6.10	E 22	20.10
E 8	7.40	E 24	22.00
E 10	9.30	E 26	23.70
E 11	9.90	E 28	25.50
E 12	11.00	E 30	27.30
E 14	12.80	E 32	29.00



1/4" 3/8" 1/2"

EPR 5 PT articolo	DESCRIZIONE
FM 16 EPR	SET 16 PEZZI, BUSSOLE TORX PLUS EPR 5 PT, 6 EPR - 32 EPR, ATT. 1/4" - 3/8" - 1/2"

- CARATTERISTICHE**
- zigrinato
 - finitura cromata satinata
 - impronta Torx Plus EPR 5 PT
 - per Tesla
 - comprende:
 - attacco 1/4", lunghezza 25 mm: 6 EPR - 7 EPR - 8 EPR - 10 EPR - 11 EPR
 - attacco 3/8", lunghezza 37 mm: 12 EPR - 14 EPR - 16 EPR - 18 EPR - 20 EPR
 - attacco 1/2", lunghezza 45 mm: 22 EPR - 24 EPR - 26 EPR - 28 EPR - 30 EPR - 32 EPR



JAPAN



ESAGONO

CHIAVI A BUSSOLA A MACCHINA BOCCA ESAGONALE

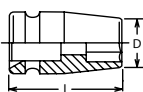

Koken articolo	mm	D mm	L mm	
12400M-4	4	7.5	23	1
12400M-4.5	4.5	8.1	23	1
12400M-5	5	8.8	23	1
12400M-5.5	5.5	9.4	23	1
12400M-6	6	10	23	1
12400M-7	7	11.3	23	1
12400M-8	8	12.5	23	1
12400M-9	9	13.8	23	1
12400M-10	10	15	23	1
12400M-11	11	16.3	23	1
12400M-12	12	17.5	23	1
12400M-13	13	18.8	23	1
12400M-14	14	20	23	1

JAPAN



ESAGONO

CHIAVI A BUSSOLA A MACCHINA BOCCA ESAGONALE TIPO LUNGO

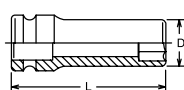

Koken articolo	mm	D mm	L mm	
12300M-6	6	10	48	1
12300M-7	7	11.3	48	1
12300M-8	8	12.5	48	1
12300M-10	10	15	48	1
12300M-11	11	16.3	48	1
12300M-12	12	17.5	48	1
12300M-13	13	18.8	48	1
12300M-14	14	20	48	1

JAPAN



SURFACE DRIVE

CHIAVI A BUSSOLA A MACCHINA BOCCA SURFACE DRIVE



Koken articolo	mm	D mm	L mm	
12410M-6	M 6	10	23	1
12410M-7	M 7	11.3	23	1
12410M-8	M 8	12.5	23	1
12410M-9	M 9	13.8	23	1
12410M-10	M 10	15	23	1
12410M-11	M 11	16.3	23	1
12410M-12	M 12	17.5	23	1
12410M-13	M 13	18.8	23	1

POLLICI



ESAGONO

CHIAVI A BUSSOLA A MACCHINA BOCCA ESAGONALE



Koken articolo	pollici	D mm	L mm	
12400A-5/32	5/32"	7.5	23	1
12400A-3/16	3/16"	8.1	23	1
12400A-7/32	7/32"	9.4	23	1
12400A-1/4	1/4"	10	23	1
12400A-9/32	9/32"	11.3	23	1
12400A-5/16	5/16"	12.5	23	1
12400A-11/32	11/32"	13.8	23	1
12400A-3/8	3/8"	15	23	1
12400A-7/16	7/16"	16.3	23	1
12400A-1/2	1/2"	18.8	23	1
12400A-9/16	9/16"	20	23	1

JAPAN



ESAGONO

CHIAVI A BUSSOLA A MACCHINA BOCCA ESAGONALE CON MAGNETE

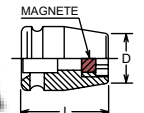

Koken articolo	mm	D mm	L mm	
12400MG-4	4	7.5	23	1
12400MG-4.5	4.5	8.1	23	1
12400MG-5	5	8.8	23	1
12400MG-5.5	5.5	9.4	23	1
12400MG-6	6	10	23	1
12400MG-7	7	11.3	23	1
12400MG-8	8	12.5	23	1
12400MG-9	9	13.8	23	1
12400MG-10	10	15	23	1
12400MG-11	11	16.3	23	1
12400MG-12	12	17.5	23	1
12400MG-13	13	18.8	23	1
12400MG-14	14	20	23	1

JAPAN



FAST LEAD

CHIAVI A BUSSOLA A MACCHINA BOCCA FAST LEAD



Koken articolo	mm	D mm	L mm	
12465M-10	10	15	23	1
12465M-11	11	16.3	23	1
12465M-12	12	17.5	23	1
12465M-13	13	18.8	23	1

POLLICI



ESAGONO

CHIAVI A BUSSOLA A MACCHINA BOCCA ESAGONALE CON MAGNETE

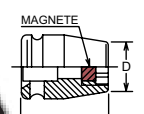

Koken articolo	pollici	D mm	L mm	
12400AG-3/16	3/16"	8.1	23	1
12400AG-1/4	1/4"	10	23	1
12400AG-5/16	5/16"	12.5	23	1
12400AG-11/32	11/32"	13.8	23	1
12400AG-3/8	3/8"	15	23	1
12400AG-7/16	7/16"	16.3	23	1
12400AG-1/2	1/2"	18.8	23	1
12400AG-9/16	9/16"	20	23	1

JAPAN



FAST LEAD

CHIAVI A BUSSOLA A MACCHINA BOCCA FAST LEAD TIPO LUNGO

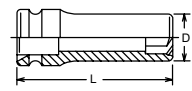

Koken articolo	mm	D mm	L mm	
12365M-10	10	15	48	1
12365M-11	11	16.3	48	1
12365M-12	12	17.5	48	1
12365M-13	13	18.8	48	1



IMPACT 1/4"



TORX®

CHIAVI A BUSSOLA A MACCHINA BOCCA TORX®

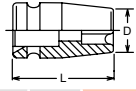

Koken articolo		D mm	L mm	
12425-E 4	E 4	6.6	23	1
12425-E 5	E 5	7.7	23	1
12425-E 6	E 6	8.7	23	1
12425-E 7	E 7	9.2	23	1
12425-E 8	E 8	9.7	23	1
12425-E 10	E 10	12.2	23	1



FERMEC FM15TPE



1/4" 3/8" 1/2" **TORXplus®**

PARETI SOTTILI SU TUTTO IL CORPO



ESAGONO

CHIAVI A BUSSOLA POWER BOCCA ESAGONALE LUNGHE



Koken articolo		D mm	L mm	
22300M-7	7	10.9	50	1
22300M-8	8	11.6	50	1
22300M-10	10	14.3	50	1
22300M-12	12	17.4	50	1
22300M-13	13	18	50	1

PARETI SOTTILI SU TUTTO IL CORPO



ESAGONO

CHIAVI A BUSSOLA POWER BOCCA ESAGONALE



Koken articolo		D mm	L mm	
22400M-6	6	9	22	1
22400M-7	7	10.2	22	1
22400M-8	8	11.3	22	1
22400M-10	10	14.3	22	1
22400M-12	12	17.4	22	1
22400M-13	13	18	22	1

DESCRIZIONE

SET 15 PEZZI, BUSSOLE TORX PLUS, IMPACT ATT. 1/4" - 3/8" - 1/2", 6 EPL - 32 EPL

CARATTERISTICHE

- impact
- impronta Torx Plus
- comprende:
 - attacco 1/4", lunghezza 25 mm: 6 EPL - 7 EPL - 8 EPL
 - attacco 3/8", lunghezza 37 mm: 10 EPL - 12 EPL - 14 EPL - 16 EPL
 - attacco 1/2", lunghezza 45 mm: 18 EPL - 20 EPL - 22 EPL - 24 EPL - 26 EPL - 28 EPL - 30 EPL - 32 EPL



POLLICI

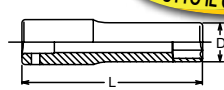

ESAGONO

CHIAVI A BUSSOLA POWER BOCCA ESAGONALE LUNGHE



Koken articolo		D mm	L mm	
22300A-1/4	1/4"	9.8	50	1
22300A-5/16	5/16"	11.6	50	1
22300A-3/8	3/8"	14.3	50	1

PARETI SOTTILI SU TUTTO IL CORPO



TORX®

CHIAVI A BUSSOLA POWER BOCCA TORX®

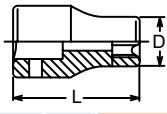

Koken articolo		D mm	L mm	
22425-E 4	E 4	5.4	23	1
22425-E 5	E 5	6.7	23	1
22425-E 6	E 6	7.7	23	1
22425-E 7	E 7	8.3	23	1
22425-E 8	E 8	9.6	23	1
22425-E 10	E 10	11.3	23	1

TORX PLUS®	S mm	S mm	
E 4	3.70	E 16	14.60
E 5	4.60	E 18	16.50
E 6	5.60	E 20	18.30
E 7	6.10	E 22	20.10
E 8	7.40	E 24	22.00
E 10	9.30	E 26	23.70
E 11	9.90	E 28	25.50
E 12	11.00	E 30	27.30
E 14	12.80	E 32	29.00



ESAGONO

CHIAVI A BUSSOLA A MACCHINA BOCCA ESAGONALE CON MAGNETE RETRATTILE





Koken articolo		D mm	L mm	
12300G-7	7	11.3	48	1
12300G-8	8	12.5	48	1
12300G-10	10	15	48	1
12300G-12	12	17.5	48	1
12300G-13	13	18.8	48	1
12300G-14	14	20	48	1

TORX®	S mm	S mm	
E 4	3.70	E 16	14.60
E 5	4.60	E 18	16.50
E 6	5.60	E 20	18.30
E 7	6.10	E 22	20.10
E 8	7.40	E 24	22.00
E 10	9.30	E 26	23.70
E 11	9.90	E 28	25.50
E 12	11.00	E 30	27.30
E 14	12.80	E 32	29.00



ESAGONO

BUSSOLE ESAGONALI MASCHIO INTEGRALI

FERMEC articolo		L mm	
182-1/4-3	3	25	1
182-1/4-4	4	25	1
182-1/4-5	5	25	1
182-1/4-6	6	25	1
182-1/4-8	8	25	1
182-1/4-10	10	25	1

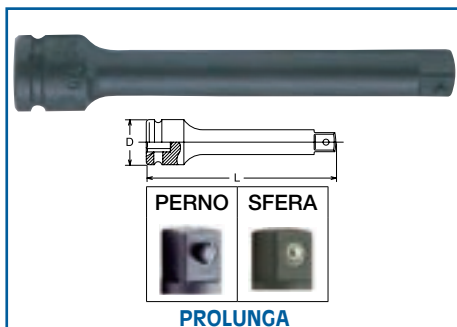

PROLUNGA

Kokon articolo	D mm		L mm	
12760-55P	13	PERNO	55	1
12760-75P	13	PERNO	75	1
12760-100P	13	PERNO	100	1
12760-150P	13	PERNO	150	1
12760-200P	13	PERNO	200	1
12760-55	13	FORO	55	1
12760-75	13	FORO	75	1
12760-100	13	FORO	100	1
12760-150	13	FORO	150	1
12760-200 <i>novità</i>	13	FORO	200	1



PERNO

1/4"

1/4"

**PROLUNGHE PER BUSSOLE
"POWER IMPACT" MASCHIO/FEMMINA**

FERMEC articolo		L mm	
97-1	PERNO	50	1
97-2	PERNO	150	1



PRO+ 1/2"

BGS articolo	DESCRIZIONE
BGS 25145	SET 9 PEZZI, PROLUNGHE IMPACT, 1/4" - 3/8" - 1/2"

- CARATTERISTICHE**
- per uso a mano e a macchina
 - con scanalatura e foro per spina
 - in cassetta in plastica
 - materiale: acciaio al cromo molibdeno
 - attacco quadro
 - finitura: nero brunito
 - comprende:
 - prolunghe impact, att. 1/4": 50 mm - 100 mm - 150 mm
 - prolunghe impact, att. 3/8": 50 mm - 75 mm - 150 mm
 - prolunghe impact, att. 1/2": 50 mm - 125 mm (BGS 193) - 250 mm (BGS 194)
 - peso 1,6 kg



SFERA

1/4"

PRO+

CRO MO

1/4"

BGS articolo	DESCRIZIONE
BGS 188	SNODO A MACCHINA

- CARATTERISTICHE**
- finitura nera
 - con sfera di tenuta
 - peso: 40 g

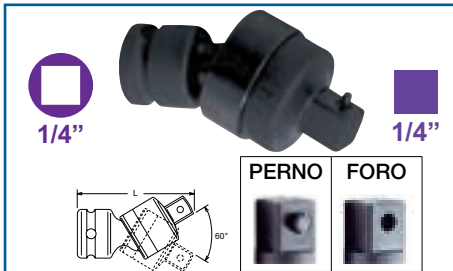

PERNO

FORO

SNODO UNIVERSALE

Kokon articolo		L mm	
12770-P	PERNO	39	1
12770	FORO	39	1



1/4" 3/8" 1/2"

PRO+

CRO MO

BGS articolo	DESCRIZIONE
BGS 9459	SET 3 PEZZI, SNODI

- CARATTERISTICHE**
- con scanalatura e foro per spina
 - comprende:
 - snodo 1/4" F - 1/4" M
 - snodo 3/8" F - 3/8" M
 - snodo 1/2" F - 1/2" M
 - peso: 420 g



ADATTATORI DOPPIO QUADRO MASCHIO

FERMEC articolo		L mm
2841	1/4"	20
3841	3/8"	30
4841	1/2"	37
BGS 9623	3/4"	53
8841	1"	68

- CARATTERISTICHE**
- con doppia sfera

IMPACT 1/4"

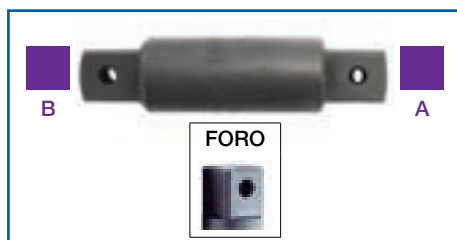

PROLUNGHE PER BUSSOLE
"POWER IMPACT" MASCHIO/MASCHIO

FEEMEC articolo	B	A	L mm	
Z 0802	1/2"	1/2"	50	1
Z 0803	1/2"	1/2"	76	1
Z 0805	1/2"	1/2"	127	1
Z 0810	1/2"	1/2"	254	1
Z 1203	3/4"	3/4"	78	1
Z 1204	3/4"	3/4"	101	1
Z 1205	3/4"	3/4"	127	1
Z 1207	3/4"	3/4"	177	1
Z 1603	1"	1"	76	1
Z 1604	1"	1"	101	1
Z 1605	1"	1"	127	1
Z 1606	1"	1"	152	1
Z 1616	1"	1"	406	1
Z 2404	1 1/2"	1 1/2"	101	1
Z 2405	1 1/2"	1 1/2"	127	1
Z 4005	2-1/2"	2-1/2"	127	1



RIDUZIONI PER BUSSOLE
"POWER IMPACT" FEMMINA/FEMMINA

FEEMEC articolo	B	A	L mm	
AN 0808	1/2"	1/2"	33	1
AN 1208	3/4"	1/2"	49	1
AN 1212	3/4"	3/4"	49	1
AN 1612	1"	3/4"	63	1
AN 1616	1"	1"	59	1
AN 2416	1-1/2"	1"	83	1
AN 2424	1 1/2"	1-1/2"	85	1



RACCORDI DI
RIDUZIONE
"POWER IMPACT"
MASCHIO/FEMMINA

Koken articolo		F	M	L mm	
12233 A-P	PERNO	1/4"	3/8"	22	1
12233 A-B	SFERA	1/4"	3/8"	22	1
12233 A	FORO	1/4"	3/8"	22	1
13322 A-P	PERNO	3/8"	1/4"	27	1
13322 A-B	SFERA	3/8"	1/4"	27	1
13322 A	FORO	3/8"	1/4"	27	1
13344 A-P	PERNO	3/8"	1/2"	32.5	1
13344 A-B	SFERA	3/8"	1/2"	32.5	1
13344 A	FORO	3/8"	1/2"	32.5	1
14433 A-P	PERNO	1/2"	3/8"	37.5	1
14433 A-B	SFERA	1/2"	3/8"	37.5	1
14433 A	FORO	1/2"	3/8"	37.5	1
14455 A	FORO	1/2"	5/8"	42	1
14466 A	FORO	1/2"	3/4"	44	1
14466 A-B	SFERA	1/2"	3/4"	44	1
14466 A-200 B	SFERA	1/2"	3/4"	200	1
14488 A-B	SFERA	1/2"	1"	58	1
14488 A-200 B	SFERA	1/2"	1"	200	1
15544 A-P	PERNO	5/8"	1/2"	46	1
15544 A	FORO	5/8"	1/2"	46	1
15566 A	FORO	5/8"	3/4"	48	1
16644 A-B	PERNO	3/4"	1/2"	54	1
16644 A-P	SFERA	3/4"	1/2"	54	1
16644 A	FORO	3/4"	1/2"	54	1
16655 A	FORO	3/4"	5/8"	55.5	1
16688 A	FORO	3/4"	1"	62	1
16688 A-250	FORO	3/4"	1"	250	1
16688 A-330	FORO	3/4"	1"	330	1
18866 A	FORO	1"	3/4"	66.5	1
18866 A-200	FORO	1"	3/4"	200	1
18877 A	FORO	1"	1-1/2"	80	1
17788 A	FORO	1-1/2"	1"	98	1
17799 A	FORO	1-1/2"	2-1/2"	115	1
19977 A	FORO	2-1/2"	1-1/2"	145	1
10099 A	FORO	3-1/2"	2-1/2"	182	1



RACCORDI DI RIDUZIONE "POWER
IMPACT" MASCHIO/FEMMINA

FEEMEC articolo	F	M	L mm		
96-00	PERNO	1/4"	3/8"	32	1
96-0	PERNO	3/8"	1/4"	35	1
96-1	PERNO	3/8"	1/2"	45	1
96-01	PERNO	1/2"	1/4"	38	1
96-2	PERNO	1/2"	3/8"	45	1
96-3	FORO	5/8"	1/2"	50	1
96-4	PERNO	3/4"	1/2"	56	1
96-8	FORO	3/4"	1"	70	1
96-9	FORO	1"	3/4"	70	1
96-10	PERNO	1"	1/2"	70	1
96-11	FORO	1/2"	3/4"	50	1
96-12	FORO	1 1/2"	1"	115	1
96-13	FORO	1"	1 1/2"	115	1
96-14	FORO	2 1/2"	1 1/2"	115	1
96-15	FORO	1 1/2"	2 1/2"	120	1
96-16	FORO	1 1/4"	1"	140	1
96-17	FORO	1 3/4"	1 1/2"	150	1



RACCORDI DI RIDUZIONE "POWER
IMPACT" MASCHIO/FEMMINA
CON SFERA DI TENUTA NEL QUADRO
MASCHIO

FEEMEC articolo	F	M	L mm	
696-00 S	1/4"	3/8"	26	1
696-0 S	3/8"	1/4"	32	1
696-01 S	1/2"	1/4"	36	1
696-1 S	3/8"	1/2"	36	1
696-2 S	1/2"	3/8"	38	1
696-11 S	1/2"	3/4"	48	1
696-4 S	3/4"	1/2"	56	1
696-8 S	3/4"	1"	63	1
696-9 S	1"	3/4"	75	1



**ARTICOLO NON
SOGGETTO A
GARANZIA**



PRO+ CROMO

BGS articolo	DESCRIZIONE
BGS 200	SET 6 PEZZI, RIDUZIONI A MACCHINA

CARATTERISTICHE

- rivestimento specifico nero opaco
- peso: 880 g

CONTENUTO

- 1/4" F X 3/8" M, coppia massima 60 Nm
- 3/8" F X 1/4" M, coppia massima 60 Nm
- 3/8" F X 1/2" M, coppia massima 200 Nm
- 1/2" F X 3/8" M, coppia massima 200 Nm
- 1/2" F X 3/4" M, coppia massima 500 Nm
- 3/4" F X 1/2" M, coppia massima 500 Nm



PRO+ CROMO

BGS articolo	DESCRIZIONE
BGS 25140	SET 11 PEZZI, RIDUZIONI E SNODI A MACCHINA

CARATTERISTICHE

- rivestimento specifico nero opaco
- peso: 2,6 kg

CONTENUTO

- 1/4" F x 3/8" M
- 3/8" F x 1/4" M
- 3/8" F x 1/2" M
- 1/2" F x 3/8" M
- 1/2" F x 3/4" M
- 3/4" F x 1/2" M
- 3/4" F x 1" M
- 1" F x 3/4" M
- snodi da 1/4", 3/8", 1/2"



SFERA

1/4"-3/8"-1/2"-3/4" 1/4"-3/8"-1/2"-3/4"

RACCORDI DI RIDUZIONE CHROM-VANADIUM

attacco: 1/4" - 3/8" - 1/2" - 3/4"

BGS articolo	FEMMINA	MASCHIO	L mm	box
BGS 271	1/4"	3/8"	1	1
BGS 269	3/8"	1/4"	1	1
BGS 280	3/8"	1/2"	1	1
BGS 270	1/2"	3/8"	1	1
BGS 272	1/2"	3/4"	1	1
BGS 274	3/4"	1/2"	1	1



SFERA

JAPAN

RACCORDO DI RIDUZIONE MASCHIO/FEMMINA CON SFERA DI TENUTA NEL QUADRO MASCHIO

attacco: 1/4"-3/8"-1/2"

Koken articolo	F	M	L mm	box
2233 A	1/4"	3/8"	22	1
3322 A	3/8"	1/4"	24	1
3344 A	3/8"	1/2"	35	1
4433 A-35	1/2"	3/8"	35	1
4433 A-75	1/2"	3/8"	75	1
4433 A-125	1/2"	3/8"	125	1
4433 A-250	1/2"	3/8"	250	1
4433 A-600	1/2"	3/8"	600	1
4466 A	1/2"	3/4"	42	1
6644 A	3/4"	1/2"	47	1
6688 A	3/4"	1"	60	1
8866 A	1"	3/4"	60	1



F M

RACCORDI DI RIDUZIONE A MANDRINO CON SGANCIO RAPIDO "POWER IMPACT"

FERMEC articolo	F	M	L mm	box
691-0 SWF	3/8"	1/4"	55	1
691-1 SWF	3/8"	1/2"	60	1
691-2 SWF	1/2"	3/8"	55	1
691-11 SWF	1/2"	3/4"	75	1
14466 AL	1/2"	3/4"	75	1
691-4 SWF	3/4"	1/2"	70	1
16644 AL	3/4"	1/2"	70	1
691-9 SWF	1"	3/4"	90	1



F M

RACCORDI DI RIDUZIONE MAGNETICI A SCOMPARSA IDEALI PER CHIAVI DINAMOMETRICHE E SPAZI RIDOTTI

attacco: 1/4"-3/8"-1/2"

FERMEC articolo	F	M	L mm	box
1434-1/4	1/4"	3/8"	1	1
1434-3/8	3/8"	1/2"	1	1
1434-1/2	1/2"	3/4"	1	1



SFERA

JAPAN

RIDUZIONI A SCOMPARSA CON SFERA NEL QUADRO MASCHIO

Koken articolo	F	M	D mm	L mm	box
2756 Z-3/8	1/4"	3/8"	20.3	21.5	1
2756 Z-1/2	1/4"	1/2"	20.3	26	1
3756 Z-1/2	3/8"	1/2"	28	29	1

RIDUZIONI IMPACT



RACCORDI DI RIDUZIONE MAGNETICI "POWER IMPACT"
A SCOMPARSA - SPAZI RIDOTTI

FEFMEC articolo	F	M	L mm	
698-00	1/4"	3/8"	17	1
698-0	1/4"	1/2"	22	1
698-1	3/8"	1/2"	22	1
698-11	1/2"	3/4"	30	1
698-8	3/4"	1"	35	1
698-13	1"	1 1/2"	50	1
698-15	1 1/2"	2 1/2"	60	1
698	CASSETTA 4 PZ. CONTENUTO: 1 PZ. 698-00 1 PZ. 698-1 1 PZ. 698-11 1 PZ. 698-8			1

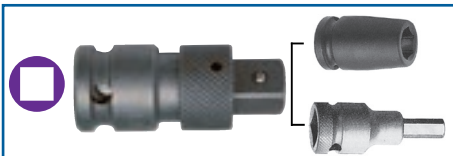

MANDRINO CON SGANCIO RAPIDO PER BUSSOLE "POWER IMPACT"

attacco: Quadro femmina
impronta: DIN 3126, E 11,2 - E 6,35

FEFMEC articolo	F	M	L mm	
195-SWF	1/4"	1/4"	41	1
196-SWF	3/8"	3/8"	46	1
97-3-125 SWF	3/8"	3/8"	125	1
197-SWF	1/2"	1/2"	60	1
199-SWF	3/4"	3/4"	78	1
1991-SWF	1"	1"	100	1

Kokoen

12222 AL	1/4"	1/4"	35	1
13333 AL	3/8"	3/8"	45	1
14444 AL	1/2"	1/2"	55	1
16666 AL	3/4"	3/4"	75	1
18888 AL	1"	1"	95	1

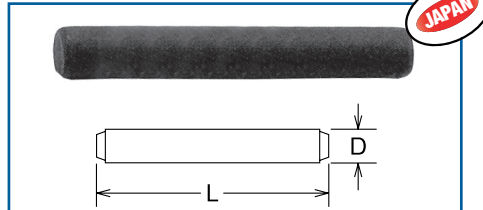

SPINE ACCIAIO PER BUSSOLE

Kokoen articolo	F	D mm	L mm	
A 21	1/4"	1.5	10,2	1
A 31	3/8"	2.5	14,5	1
A 32	3/8"	2.5	17,5	1
A 41	1/2"	3.0	20	1
A 42	1/2"	3.0	25	1
A 51	5/8"	4.0	29	1
A 61	3/4"	4.0	35	1
A 62	3/4"	4.0	45	1
A 81	1"	5.0	45	1
A 82	1"	5.0	57	1
A 83	1"	5.0	75	1
A 71	1 1/2"	6.0	75	1
A 72	1 1/2"	6.0	110	1
A 91	2 1/2"	8.0	110	1
A 92	2 1/2"	8.0	155	1
A 01	3 1/2"	13.0	155	1
A 02	3 1/2"	13.0	180	1

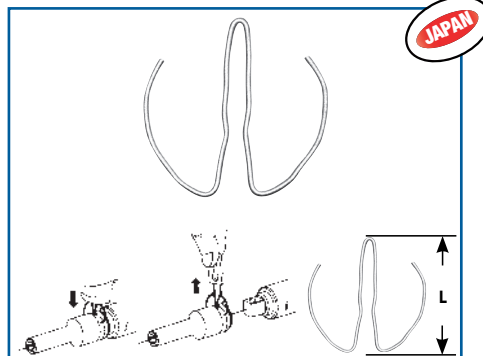

MOLLA DI SICUREZZA PER BUSSOLE

Kokoen articolo	F	Ø	L mm	
C 31	3/8"	≤ 12	18	1
C 32	3/8"	> 12	20	1
C 41	1/2"	≤ 14	23	1
C 42	1/2"	> 14	26	1
C 61	3/4"	≤ 46	41	1
C 81	1"	≤ 46	50	1
C 82	1"	> 46		1
C 83	1"	> 70		1
C 71	1 1/2"	≤ 90		1

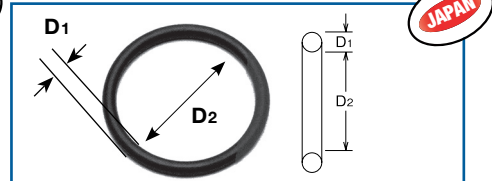

ANELLI DI GOMMA PER BUSSOLE

Kokoen articolo	F	D 1 mm	D 2 mm	
B 21	1/4"	2.5	9	1
B 31	3/8"	3.5	13	1
B 32	3/8"	3.5	16	1
B 41	1/2"	4	19	1
B 42	1/2"	4	24	1
B 51	5/8"	5	28	1
B 61	3/4"	5	36	1
B 62	3/4"	5	45	1
B 81	1"	7	45	1
B 82	1"	7	57	1
B 83	1"	7	75	1
B 71	1 1/2"	10	75	1
B 72	1 1/2"	10	114	1
B 91	2 1/2"	10.5	114	1
B 92	2 1/2"	10.5	158	1
B 01	3 1/2"	15	158	1
B 02	3 1/2"	15	183	1



ESTRATTORE PER MOLLE DI SICUREZZA

Kokoen articolo	F		
149	3/8"	- 1/2"	1
152	3/4"	- 1"	1



SET MOLLE DI SICUREZZA PER BUSSOLE

Kokoen articolo	nr.		
PKC 31	10	149	1
PKC 32	10	149	1
PKC 41	10	149	1
PKC 42	10	149	1
PKC 61	10	152	1
PKC 81	10	152	1

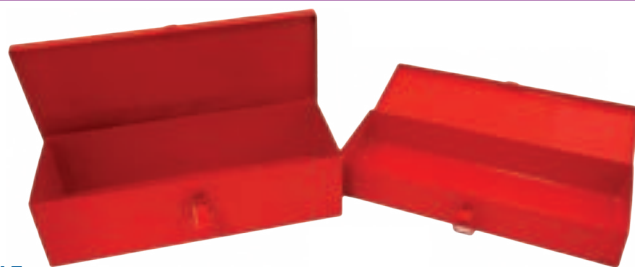

CASSETTE METALLICHE PORTA-BUSSOLE

FEARMEC articolo	lunghezza (mm)	larghezza (mm)	altezza (mm)	
CASS-2510	240	100	60	1
CASS-2810	280	130	75	1
CASS-3009	300	90	45	1
CASS-3112	310	120	80	1
CASS-3211	320	120	50	1
CASS-4220	420	200	140	1
CASS-6213	610	130	80	1

NOTE

- a richiesta assortimenti di bussole a macchina in cassetta metallica



PRO+

GUIDE PORTA BUSSOLE CON CLIP

BGS articolo		Numero Clip
BGS 2316	1/4"	7
BGS 2317	3/8"	7
BGS 2318	1/2"	7
BGS 2120	1/4"	15
BGS 2330	3/8"	15
BGS 2540	1/2"	15
BGS 3460	3/4"	12

CARATTERISTICHE

- cromato satinato



GUIDE PORTA BUSSOLE PER MOLLE IN ACCIAIO DA 1/4" - 3/8" - 1/2" - 3/4"

Koken articolo	L mm	
R 158	158	1
R 251	251	1
R 300	300	1
R 400	400	1



MOLLE IN ACCIAIO PER GUIDE

Koken articolo		
C 14	1/4"	1
C 38	3/8"	1
C 12	1/2"	1
C 34	3/4"	1

BGS 74549



BGS 74550



BGS 74551



PRO+

GUIDE MAGNETICHE PORTABUSSOLE, CON CLIP

BGS articolo	DESCRIZIONE	PESO GR.
BGS 74549	1/4"	260 GR.
BGS 74550	3/8"	270 GR.
BGS 74551	1/2"	300 GR.

CARATTERISTICHE

- adatto per bussole attacco:
 - BGS 74549: 1/4"
 - BGS 74550: 3/8"
 - BGS 74551: 1/2"
- con 12 clip
- con supporto in plastica
- base del supporto magnetica: garantisce la tenuta su tutte le superfici ferrose, su carrelli da officina, combinazioni di sistemi di stoccaggio, macchine, piattaforme di sollevamento e cassette in metallo
- base con fori a ciascuna estremità per l'installazione a parete
- materiale: alluminio / plastica
- dimensioni (larghezza - altezza - lunghezza):
 - BGS 74549, attacco 1/4": 28 x 20 x 420 mm
 - BGS 74550, attacco 3/8": 28 x 22 x 420 mm
 - BGS 74551, attacco 1/2": 28 x 25 x 420 mm

novità





JAPAN



GUIDE MAGNETICHE PORTA BUSSOLE CON CLIP IDEALI PER USO SU PONTI SOLLEVATORI



Koken articolo		Nr. Clip	L mm	
RSAL 200-1/4X12	1/4"	12	200	1
RSAL 200-3/8X8	3/8"	8	200	1
RSAL 300-3/8X12	3/8"	12	300	1
RSAL 300-1/2X10	1/2"	10	300	1



JAPAN

**GUIDE PORTA BUSSOLE
MAGNETICHE PER MOLLE
IN PLASTICA**



Koken articolo	L mm	
RSAL-200	200	1
RSAL-300	300	1



JAPAN

MOLLE IN PLASTICA PER GUIDE

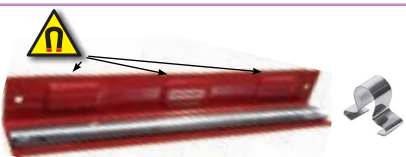
Koken articolo		
CLIP-1/4	1/4"	1
CLIP-3/8	3/8"	1
CLIP-1/2	1/2"	1

**GUIDA MAGNETICA PER MOLLE PORTA
BUSSELE DA 1/4" - 3/8" - 1/2" - 3/4"**

FERMEC articolo	L mm	
MAG 300	300	1

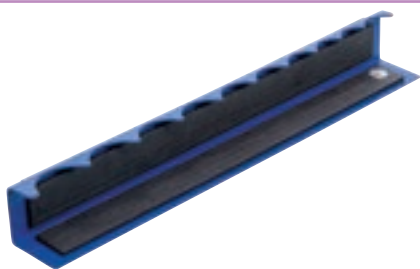

PRO+

BARRA PORTABUSSOLE MAGNETICA,

BGS articolo		Numero vani
BGS 3011-1	1/4"	10
BGS 3011-2	3/8"	12
BGS 3011-3	1/2"	10

CARATTERISTICHE

- le bussole sono trattenute grazie ad una banda magnetica

BGS HANGER-1

1/4"

BGS HANGER-2

3/8"

BGS HANGER-3

1/2"

BGS HANGER-4

3/4"

BGS HANGER-5



1"

CLIP X ATTACCO QUADRO FEMMINA

BGS articolo	
BGS HANGER-1	1/4"
BGS HANGER-2	3/8"
BGS HANGER-3	1/2"
BGS HANGER-4	3/4"
BGS HANGER-5	1"

CARATTERISTICHE

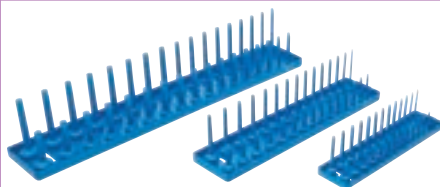
- clip in plastica con quadro maschio
- ad esempio per esposizione bussole



1/4"

3/8"

1/2"

PRO+

BGS articolo	DESCRIZIONE
BGS 67158	SET 3 PEZZI PORTA-BUSSOLE

CARATTERISTICHE

- con occhio per appendere o per il montaggio a parete
- adatto per bussole corte e lunghe
- materiale: plastica
- comprende:
 - 1 supporto per 28 bussole attacco 1/4"
 - 1 supporto per 30 bussole attacco 3/8"
 - 1 supporto per 34 bussole attacco 1/2"
- peso: 630 g

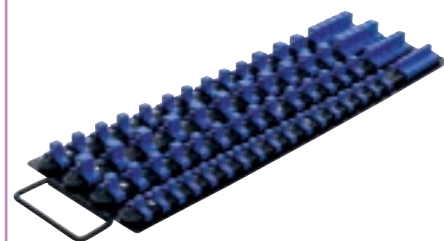

1/4"

3/8"

1/2"

PRO+

BGS articolo	DESCRIZIONE
BGS 6871	SET GUIDE PER BUSSELE, CON 80 CLIP, PER BUSSELE 1/4", 3/8" E 1/2"

CARATTERISTICHE

- ideale per lo stoccaggio delle bussole
- comprende:
 - 26 clip con sfera: 1/4"
 - 30 clip con sfera: 3/8"
 - 24 clip con sfera: 1/2"
 - 4 guide
 - piastra di fissaggio
- peso: 1,0 kg

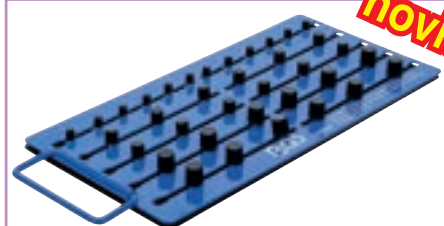

novità

1/4"

3/8"

1/2"



PRO+

BGS articolo	DESCRIZIONE
BGS 74484	PIASTRA MAGNETICA, CON IMPUGNATURA, PER 36 BUSSELE ATTACCO 1/4", 3/8" E 1/2"

CARATTERISTICHE

- pratico supporto per bussole
- 12 clip magnetiche rotondi per ogni misura
- le clip magnetiche garantiscono una tenuta sicura la facilità di rimozione
- potente superficie magnetica della piastra
- per il fissaggio temporaneo a superfici metalliche, scaffali o carrelli da officina
- con impugnatura in metallo per appendere o trasportare
- portata massima: 5 kg
- larghezza: 155 mm
- altezza: 6 mm
- lunghezza: 335 mm
- peso: 1,4 kg



Koken articolo	mm	D ₁ mm	L mm	
3400M-5	5	8.3	26	1
3400M-5.5	5,5	8.9	26	1
3400M-6	6	9.9	26	1
3400M-7	7	10.8	26	1
3400M-8	8	12	26	1
3400M-9	9	13.3	26	1
3400M-10	10	14.5	26	1
3400M-11	11	15.8	26	1
3400M-12	12	16.8	26	1
3400M-13	13	18	26	1
3400M-14	14	19.5	27	1
3400M-15	15	20.8	28	1
3400M-16	16	22	28	1
3400M-17	17	23.3	29	1
3400M-18	18	24.5	30	1
3400M-19	19	25.8	30	1
3400M-20	20	27	31	1
3400M-21	21	28	32	1
3400M-22	22	29.5	32	1
3400M-23	23	30.8	33	1
3400M-24	24	32	34	1
3400M-25	25	33.3	34	1
3400M-26	26	34.5	35	1



Koken articolo	mm	D ₁ mm	l mm	L mm	
3400M-24-27	27	36.5	13.5	24	1
3400M-24-30	30	40	13.5	24	1
3400M-24-32	32	42.8	13.5	24	1
3400M-24-36	36	47.2	13.5	24	1



Koken articolo	mm	D ₁ mm	L mm	
3405M-5	5	9.9	26	1
3405M-5.5	5.5	9.9	26	1
3405M-6	6	9.9	26	1
3405M-7	7	10.8	26	1
3405M-8	8	12	26	1
3405M-9	9	13.3	26	1
3405M-10	10	14.5	26	1
3405M-11	11	15.8	26	1
3405M-12	12	16.8	26	1
3405M-13	13	18	26	1
3405M-14	14	19.5	27	1
3405M-15	15	20.8	28	1
3405M-16	16	22	28	1
3405M-17	17	23.3	29	1
3405M-18	18	24.5	30	1
3405M-19	19	25.8	30	1
3405M-20	20	27	31	1
3405M-21	21	28	32	1
3405M-22	22	29.5	32	1
3405M-23	23	30.8	33	1
3405M-24	24	32	34	1
3405M-25	25	33.3	34	1
3405M-26	26	34.5	35	1



FM 31032

CARATTERISTICHE

- inserti speciali che, utilizzati all'interno delle bussole esagonali tradizionali, consentono di prevenire danni a parti cromate o verniciate o, più in generale, con trattamenti superficiali
- comprende:
 - inserto 8 mm, per bussola 12 mm, coppia 9 Nm
 - inserto 10 mm, per bussola 14 mm, coppia 17 Nm
 - inserto 12 mm, per bussola 16 mm, coppia 27 Nm
 - inserto 13 mm, per bussola 17 mm, coppia 45 Nm
 - inserto 15 mm, per bussola 19 mm, coppia 50 Nm
 - inserto 17 mm, per bussola 22 mm, coppia 79 Nm
- per uso con bussole esagonali metriche



Koken articolo	pollici	D ₁ mm	L mm	
3400A-3/16	3/16"	8.3	26	1
3400A-1/4	1/4"	10.3	26	1
3400A-9/32	9/32"	10.8	26	1
3400A-5/16	5/16"	12	26	1
3400A-11/32	11/32"	13.3	26	1
3400A-3/8	3/8"	13.9	26	1
3400A-13/32	13/32"	13.3	26	1
3400A-7/16	7/16"	15.8	26	1
3400A-1/2	1/2"	18	26	1
3400A-9/16	9/16"	19.5	27	1
3400A-19/32	19/32"	20.8	28	1
3400A-5/8	5/8"	22	28	1
3400A-11/16	11/16"	24.5	30	1
3400A-3/4	3/4"	25.8	30	1
3400A-25/32	25/32"	27	31	1
3400A-13/16	13/16"	28	32	1
3400A-7/8	7/8"	29.5	32	1
3400A-15/16	15/16"	32	34	1
3400A-1	1"	34.5	35	1



Koken articolo	pollici	D ₁ mm	L mm	
3405A-3/16	3/16"	8.3	26	1
3405A-1/4	1/4"	10.3	26	1
3405A-9/32	9/32"	10.8	26	1
3405A-5/16	5/16"	12	26	1
3405A-11/32	11/32"	13.3	26	1
3405A-3/8	3/8"	13.9	26	1
3405A-13/32	13/32"	13.3	26	1
3405A-7/16	7/16"	15.8	26	1
3405A-1/2	1/2"	18	26	1
3405A-9/16	9/16"	19.5	27	1
3405A-19/32	19/32"	20.8	28	1
3405A-5/8	5/8"	22	28	1
3405A-11/16	11/16"	24.5	30	1
3405A-3/4	3/4"	25.8	30	1
3405A-25/32	25/32"	27	31	1
3405A-13/16	13/16"	28	32	1
3405A-7/8	7/8"	29.5	32	1
3405A-15/16	15/16"	32	34	1
3405A-1	1"	34.5	35	1



SURFACE DRIVE

CHIAVI A BUSSOLA A MANO BOCCA SURFACE DRIVE

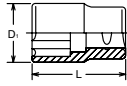

Koken articolo	mm	D ₁ mm	L mm	
3410M-5.5	5.5	8.9	26	1
3410M-6	6	9.9	26	1
3410M-7	7	10.8	26	1
3410M-8	8	12	26	1
3410M-9	9	13.3	26	1
3410M-10	10	14.5	26	1
3410M-11	11	15.8	26	1
3410M-12	12	16.8	26	1
3410M-13	13	18	26	1
3410M-14	14	19.5	27	1
3410M-15	15	20.8	28	1
3410M-16	16	22	28	1
3410M-17	17	23.3	29	1
3410M-18	18	24.5	30	1
3410M-19	19	25.8	30	1
3410M-20	20	27	31	1
3410M-21	21	28	32	1
3410M-22	22	29.5	32	1
3410M-23	23	30.8	33	1
3410M-24	24	32	34	1

BUSSOLE SURFACE DRIVE

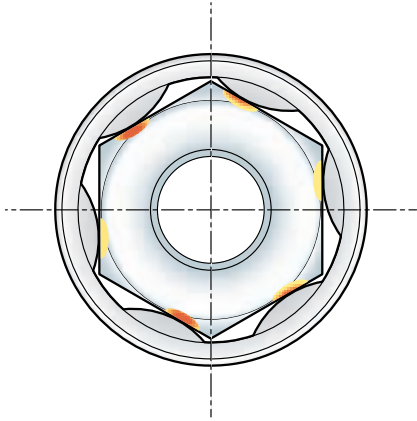

TORX

CHIAVI A BUSSOLA A MANO BOCCA TORX®

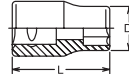

Koken articolo		D ₁ mm	L mm	
3425-E 4	E 4	17.3	26	1
3425-E 5	E 5	17.3	26	1
3425-E 6	E 6	17.3	26	1
3425-E 7	E 7	17.3	26	1
3425-E 8	E 8	17.3	26	1
3425-E10	E 10	17.3	26	1
3425-E11	E 11	17.3	26	1
3425-E12	E 12	17.3	26	1
3425-E14	E 14	17.3	26	1
3425-E16	E 16	17	26	1



TORX BLOCCADADI

CHIAVI A BUSSOLA A MANO BOCCA TORX® BLOCCADADI

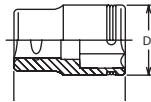

Koken articolo		D mm	L mm	
3425-2B-E10	E 10	12	26	1
3425-2B-E12	E 12	14.5	26	1
3425-2B-E14	E 14	15.8	26	1
3425-2B-E16	E 14	18.1	26	1
3425-2B-E18	E 14	19.5	26	1
3425-2B-E20	E 20	21.9	26	1

TORX®

	S mm	S mm	
E 4	3.70	E 16	14.60
E 5	4.60	E 18	16.50
E 6	5.60	E 20	18.30
E 7	6.10	E 22	20.10
E 8	7.40	E 24	22.00
E 10	9.30	E 26	23.70
E 11	9.90	E 28	25.50
E 12	11.00	E 30	27.30
E 14	12.80	E 32	29.00



OTTAGONALE OTTO ANGOLI

CHIAVI A BUSSOLA A MANO BOCCA OTTAGONALE

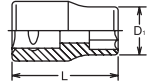

Koken articolo	mm	D ₁ mm	L mm	
3415M-5.5	5.5	10.8	21	1
3415M-6	6	12	26	1
3415M-7	7	13.3	26	1
3415M-8	8	14.5	26	1
3415M-10	10	16.8	26	1
3415M-12	12	20.8	27	1
3415M-13	13	21.9	27	1

POLLICI



OTTAGONALE OTTO ANGOLI

CHIAVI A BUSSOLA A MANO BOCCA OTTAGONALE

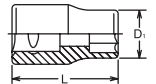



Koken articolo	pollici	D ₁ mm	L mm	
3415A-1/4	1/4"	12	26	1
3415A-5/16	5/16"	14.5	26	1
3415A-11/32	11/32"	15.8	26	1
3415A-3/8	3/8"	16.8	26	1
3415A-7/16	7/16"	19.5	27	1
3415A-1/2	1/2"	22	27	1

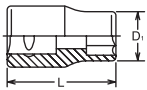

SYSTEM 6

CHIAVI A BUSSOLA A MANO BOCCA SYSTEM 6





Koken articolo		D mm	L mm	
3400LH-5S	5 S	17.3	26	1
3400LH-6S	6 S	17.3	26	1
3400LH-8S	8 S	17.3	26	1
3400LH-10S	10 S	17.3	26	1
3400LH-12S	12 S	17.3	28	1
3400LH-14S	14 S	17.3	30	1
3400LH-16S	16 S	17	32	1

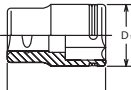

NUT GRIP® BLOCCADADI

CHIAVI A BUSSOLA A MANO BOCCA NUT GRIP® BLOCCADADI



Koken articolo		mm	D mm	L mm	
3450M-8		8	12	26	1
3450M-10		10	14.5	26	1
3450M-11		11	15.8	26	1
3450M-12		12	16.8	26	1
3450M-13		13	18	26	1
3450M-14		14	19.5	27	1
3450M-15		15	20.8	27	1
3450M-16		16	22	27	1
3450M-17		17	23.3	28	1
3450M-18		18	24.5	29	1
3450M-19		19	25.8	29	1
3450M-21		21	28	29	1
3450M-22		22	29.5	29	1
3450M-24		24	32	31	1

POLLICI

3450A-1/4	novità	1/4"	10.3	26
3450A-5/16	novità	5/16"	12	26
3450A-3/8	novità	3/8"	13.9	26
3450A-7/16	novità	7/16"	15.8	26
3450A-1/2	novità	1/2"	18	26
3450A-9/16	novità	9/16"	19.5	27
3450A-5/8	novità	5/8"	22	27
3450A-11/16	novità	11/16"	24.6	29
3450A-3/4	novità	3/4"	26	29

LHSTIX®

	d mm	D mm
LH 3 S	3.80	4.70
LH 4 S	4.50	6.00
LH 5 S	5.60	7.50
LH 6 S	6.80	9.00
LH 7 S	7.90	10.50
LH 8 S	9.00	12.00
LH 10 S	11.30	15.00
LH 12 S	13.60	18.00
LH 14 S	15.80	21.00
LH 16 S	18.10	24.00



SERIE 12 PZ. CHIAVI A BUSSOLA MISURE: 8, 9, 10, 11, 12, 13, 14, 15, 16, 17, 18, 19 MM

DISPONIBILI CON BOCCA: ESAGONALE/POLIGONALE

Koken articolo		L mm	
RS 3400M/12		22	1
RS 3405M/12		22	1

POLLICI



SERIE 9 PZ. CHIAVI A BUSSOLA MISURE: 1/4", 5/16", 3/8", 7/16", 1/2", 9/16", 5/8", 11/16", 3/4"

DISPONIBILI CON BOCCA: ESAGONALE/POLIGONALE

Koken articolo		
RS 3400A/9		1
RS 3405A/9		1



ESAGONO

SERIE 8 PZ. CHIAVI A BUSSOLA BOCCA ESAGONALE EXTRA CORTE

Koken articolo		mm	
RS 3400MZ/8		8, 10, 11, 12, 13, 14, 17, 19	1



TORX®



SERIE 9 PZ. CHIAVI A BUSSOLA BOCCA TORX®

Koken articolo			
RS 3425/9		E4, E5, E6, E7, E8, E10, E12, E14, E16	1







SERIE 14 PZ. CHIAVI A BUSSOLA BOCCA TORX®



Koken articolo		
RSX 425/14	E4, E5, E6, E7, E8, E10, E11, E12, E14, E16, E18, E20, E22, E24	1

CONTENUTO

	2425	E4, E5, E6, E7, E8
	3425	E10, E11, E12, E14
	4425	E16, E18, E20, E22, E24





SERIE 7 PZ. CHIAVI A BUSSOLA MASCHIO SYSTEM 6

Koken articolo		
RS 3400LH/7	5S, 6S, 8S, 10S, 12S, 14S, 16S	1

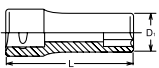

CHIAVI A BUSSOLA A MANO BOCCA ESAGONALE SEMI LUNGHE



Koken articolo	mm	D ₁ mm	L mm	
3300X-8	8	12	40	1
3300X-9	9	13	40	1
3300X-10	10	14.5	40	1
3300X-11	11	16	40	1
3300X-12	12	16.8	40	1
3300X-13	13	18	40	1
3300X-14	14	20	40	1
3300X-15	15	21	40	1
3300X-16	16	22	40	1
3300X-17	17	23.5	40	1
3300X-18	18	24.5	40	1
3300X-19	19	25	40	1



CHIAVI A BUSSOLA A MANO BOCCA POLIGONALE SEMI LUNGHE

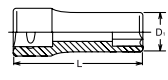

Koken articolo	mm	D ₁ mm	L mm	
3305X-8	8	12	40	1
3305X-9	9	13	40	1
3305X-10	10	14.5	40	1
3305X-11	11	16	40	1
3305X-12	12	16.8	40	1
3305X-13	13	18	40	1
3305X-14	14	20	40	1
3305X-15	15	21	40	1
3305X-16	16	22	40	1
3305X-17	17	23.5	40	1
3305X-18	18	24.5	40	1
3305X-19	19	25	40	1



CHIAVI A BUSSOLA A MANO BOCCA ESAGONALE LUNGHE

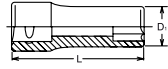

Koken articolo	mm	D ₁ mm	L mm	
3300M-5.5	5.5	8.9	55	1
3300M-6	6	9.9	55	1
3300M-7	7	10.6	55	1
3300M-8	8	12	55	1
3300M-9	9	13	55	1
3300M-10	10	14.5	55	1
3300M-11	11	16	55	1
3300M-12	12	16.8	55	1
3300M-13	13	18	55	1
3300M-14	14	20	55	1
3300M-15	15	21	55	1
3300M-16	16	22	55	1
3300M-17	17	23.5	55	1
3300M-18	18	24.5	55	1
3300M-19	19	25	55	1
3300M-20	20	26	65	1
3300M-21	21	27	65	1
3300M-22	22	29	65	1
3300M-23	23	30	65	1
3300M-24	24	31	65	1
3300M-25	25	33	65	1
3300M-26	26	34	65	1
3300M-27	27	35	65	1



CHIAVI A BUSSOLA A MANO BOCCA ESAGONALE EXTRA LUNGHE



Koken articolo	mm	D ₁ mm	L mm	
3300M-120-8	8	12	120	1
3300M-120-10	10	14.5	120	1
3300M-120-12	12	16.8	120	1
3300M-120-13	13	18	120	1
3300M-120-14	14	20	120	1



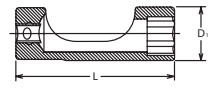

CHIAVI A BUSSOLA A MANO BOCCA ESAGONALE PER INIETTORI



Koken articolo	mm	D ₁ mm	L mm	
3300FN-8	8	14.5	53	1
3300FN-9	9	16	53	1
3300FN-10	10	16.8	53	1
3300FN-11	11	18	53	1
3300FN-12	12	20	53	1
3300FN-13	13	21.1	62	1
3300FN-14	14	22	62	1
3300FN-15	15	23	70	1
3300FN-16	16	24	70	1
3300FN-17	17	25	80	1
3300FN-18	18	27	80	1
3300FN-19	19	28	80	1
3300FN-21 <small>novità</small>	21	30	80	1
3300FN-22	22	32	80	1
3300FN-24	24	34.5	80	1



SERIE 8 PZ. CHIAVI A BUSSOLA BOCCA ESAGONALE PER INIETTORI

Koken articolo		
RS 3300FN/8	9, 10, 11, 13, 14, 16, 17, 19	1

GAMMA COMPLETA BUSSOLE PER INIETTORI A PAG. XXX

KOKEN 3/8"



BGS articolo	DESCRIZIONE
BGS 9863	SET 5 PEZZI, BUSSOLE ESAGONALI 8-14 MM, EXTRA LUNGHE, ATT. 3/8",

- CARATTERISTICHE**
- misure: 8-10-12-13-14 mm
 - finitura cromata lucida
 - attacco quadro 3/8"
 - esagonali
 - **lunghezza: 120 mm**
 - peso: 870 g



CHIAVI A BUSSEOLA A MANO BOCCA POLIGONALE LUNGHE

Koken articolo	mm	D ₁ mm	L mm	
3305M-5.5	5.5	8.9	55	1
3305M-6	6	9.9	55	1
3305M-7	7	10.6	55	1
3305M-8	8	12	55	1
3305M-9	9	13	55	1
3305M-10	10	14.5	55	1
3305M-11	11	16	55	1
3305M-12	12	16.8	55	1
3305M-13	13	18	55	1
3305M-14	14	20	55	1
3305M-15	15	21	55	1
3305M-16	16	22	55	1
3305M-17	17	23.5	55	1
3305M-18	18	24.5	55	1
3305M-19	19	25	55	1
3305M-20	20	26	65	1
3305M-21	21	27	65	1
3305M-22	22	29	65	1
3305M-23	23	30	65	1
3305M-24	24	31	65	1
3305M-25	25	33	65	1
3305M-26	26	34	65	1
3305M-27	27	35	65	1



CHIAVI A BUSSEOLA A MANO BOCCA POLIGONALE EXTRA LUNGHE

Koken articolo	mm	D ₁ mm	L mm	
3305M-120-8	8	12	120	1
3305M-120-10	10	14.5	120	1
3305M-120-12	12	16.8	120	1
3305M-120-13	13	18	120	1
3305M-120-14	14	20	120	1



CHIAVI A BUSSEOLA A MANO BOCCA ESAGONALE LUNGHE

Koken articolo	pollici	D ₁ mm	L mm	
3300A-7/32	7/32"	8.9	55	1
3300A-1/4	1/4"	9.9	55	1
3300A-5/16	5/16"	12	55	1
3300A-11/32	11/32"	12.3	55	1
3300A-3/8	3/8"	14	55	1
3300A-7/16	7/16"	16	55	1
3300A-1/2	1/2"	18	55	1
3300A-9/16	9/16"	20	55	1
3300A-19/32	19/32"	21	55	1
3300A-5/8	5/8"	22	55	1
3300A-11/16	11/16"	23.5	55	1
3300A-3/4	3/4"	25	55	1
3300A-13/16	13/16"	27	65	1
3300A-7/8	7/8"	29	65	1
3300A-15/16	15/16"	31	65	1



CHIAVI A BUSSEOLA A MANO BOCCA POLIGONALE LUNGHE

Koken articolo	pollici	D ₁ mm	L mm	
3305A-3/16 <small>novità</small>	3/16"	6.3	55	1
3305A-7/32	7/32"	8.9	55	1
3305A-1/4	1/4"	9.9	55	1
3305A-5/16	5/16"	12	55	1
3305A-11/32	11/32"	12.3	55	1
3305A-3/8	3/8"	14	55	1
3305A-7/16	7/16"	16	55	1
3305A-1/2	1/2"	18	55	1
3305A-9/16	9/16"	20	55	1
3305A-19/32	19/32"	21	55	1
3305A-5/8	5/8"	22	55	1
3305A-11/16	11/16"	23.5	55	1
3305A-3/4	3/4"	25	55	1
3305A-13/16	13/16"	27	65	1
3305A-7/8	7/8"	29	65	1
3305A-15/16	15/16"	31	65	1





SURFACE DRIVE

CHIAVI A BUSSOLA A MANO BOCCA SURFACE DRIVE

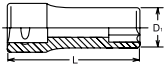

Koken articolo	mm	D ₁ mm	L mm	
3310M-6	6	9.9	55	1
3310M-7	7	10.6	55	1
3310M-8	8	12	55	1
3310M-9	9	13	55	1
3310M-10	10	14.5	55	1
3310M-11	11	16	55	1
3310M-12	12	16.8	55	1
3310M-13	13	18	55	1
3310M-14	14	20	55	1
3310M-15	15	21	55	1
3310M-16	16	22	55	1
3310M-17	17	23.5	55	1
3310M-18	18	24.5	55	1
3310M-19	19	25	55	1
3310M-20	20	26	65	1
3310M-21	21	27	65	1
3310M-22	22	29	65	1
3310M-23	23	30	65	1
3310M-24	24	31	65	1

BUSSOLE SURFACE DRIVE

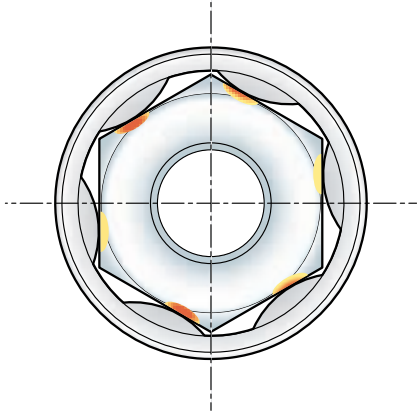

TORX®

CHIAVI A BUSSOLA A MANO BOCCA TORX®

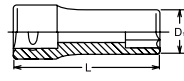

Koken articolo		D ₁ mm	L mm	
3325-E 4	E 4	5.6	55	1
3325-E 5	E 5	6.9	55	1
3325-E 6	E 6	7.9	55	1
3325-E 7	E 7	8.9	55	1
3325-E 8	E 8	9.9	55	1
3325-E10	E 10	11.8	55	1
3325-E11	E 11	13	55	1
3325-E12	E 12	14.5	55	1
3325-E14	E 14	15.7	55	1
3325-E16	E 16	18	55	1



NUT GRIP® BLOCCADADI



CHIAVI A BUSSOLA A MANO BOCCA NUT GRIP®

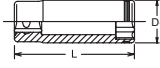

Koken articolo	mm	D ₁ mm	L mm	
3350M-8	8	12	55	1
3350M-10	10	14.5	55	1
3350M-12	12	16.8	55	1
3350M-13	13	18	55	1
3350M-14	14	19.5	55	1

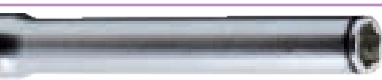
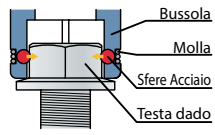

NUT GRIP® BLOCCADADI

CHIAVI A BUSSOLA A MANO BOCCA NUT GRIP® EXTRA LUNGHE

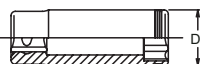

Koken articolo	mm	D ₁ mm	L mm	
3350M-L120-8	8	12	120	
3350M-L120-10	10	14.5	120	1
3350M-L120-12	12	16.8	120	1

POLLICI

3350A-L120-7/16	novità 7/16"	15.8	120	1
3350A-L120-1/2	novità 1/2"	18	120	1
3350A-L120-9/16	novità 9/16"	20	120	1



SERIE 12 PZ. CHIAVI A BUSSOLA LUNGHE MISURE: 8, 9, 10, 11, 12, 13, 14, 15, 16, 17, 18, 19 MM

DISPONIBILI CON BOCCA: ESAGONALE/POLIGONALE

Koken articolo		
RS 3300M/12		1
RS 3305M/12		1

POLLICI



SERIE 9 PZ. CHIAVI A BUSSOLA LUNGHE MISURE: 1/4", 5/16", 3/8", 7/16", 1/2", 9/16", 5/8", 11/16", 3/4"

DISPONIBILI CON BOCCA: ESAGONALE/POLIGONALE

Koken articolo		
RS 3300A/9		1
RS 3305A/9		1



TORX®

SERIE 9 PZ. CHIAVI A BUSSOLA BOCCA TORX®

Koken articolo		
RS 3325/9	E4, E5, E6, E7, E8, E10, E12, E14, E16	1

TORX®	S mm	S mm	
E 4	3.70	E 16	14.60
E 5	4.60	E 18	16.50
E 6	5.60	E 20	18.30
E 7	6.10	E 22	20.10
E 8	7.40	E 24	22.00
E 10	9.30	E 26	23.70
E 11	9.90	E 28	25.50
E 12	11.00	E 30	27.30
E 14	12.80	E 32	29.00

KOKEN 3/8"



ESAGONO

CHIAVI A BUSSOLA A MANO SNODATE BOCCA ESAGONALE

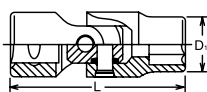

Koken articolo	mm	D ₁ mm	L mm	
3440M-8	8	12	47	1
3440M-9	9	13.3	47.5	1
3440M-10	10	14.5	48.5	1
3440M-11	11	15.8	49.5	1
3440M-12	12	17	50	1
3440M-13	13	18.3	51	1
3440M-14	14	19.5	51	1
3440M-15	15	20.8	53.5	1
3440M-16	16	22	53.5	1
3440M-17	17	23.3	54.5	1
3440M-18	18	24.5	54.5	1
3440M-19	19	25.8	56.5	1
3440M-21	21	28.3	56.5	1

POLLICI



ESAGONO

CHIAVI A BUSSOLA A MANO SNODATE BOCCA ESAGONALE





Koken articolo	pollici	D ₁ mm	L mm	
3440A-5/16	5/16"	12	47	1
3440A-3/8	3/8"	14	48	1
3440A-7/16	7/16"	15.8	49.5	1
3440A-1/2	1/2"	18.3	51	1
3440A-9/16	9/16"	19.5	51	1
3440A-5/8	5/8"	22	53.5	1
3440A-11/16	11/16"	24.5	54.5	1
3440A-3/4	3/4"	25.8	56.5	1

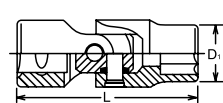

ESAGONO

CHIAVI A BUSSOLA A MANO SNODATE BOCCA ESAGONALE





Koken articolo	mm	D ₁ mm	L mm	
3340M-75-8	8	12	75	1
3340M-75-9	9	12	75	1
3340M-75-10	10	14.5	75	1
3340M-75-11	11	15.8	75	1
3340M-75-12	12	17	75	1
3340M-75-13	13	18.3	75	1
3340M-75-14	14	19.5	75	1
3340M-75-15	15	20.8	75	1
3340M-75-16	16	22	75	1
3340M-75-17	17	23.3	75	1
3340M-75-18	18	24.5	75	1
3340M-75-19	19	25.8	75	1

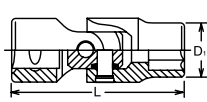

POLIGONALE

CHIAVI A BUSSOLA A MANO SNODATE BOCCA POLIGONALE



Koken articolo	mm	D ₁ mm	L mm	
3445M-8	8	12	47	1
3445M-9	9	13.3	47.5	1
3445M-10	10	14.5	48.5	1
3445M-11	11	15.8	49.5	1
3445M-12	12	17	50	1
3445M-13	13	18.3	51	1
3445M-14	14	19.5	51	1
3445M-15	15	20.8	53.5	1
3445M-16	16	22	53.5	1
3445M-17	17	23.3	54.5	1
3445M-18	18	24.5	54.5	1
3445M-19	19	25.8	56.5	1
3445M-21	21	28.3	56.5	1

POLLICI



POLIGONALE

CHIAVI A BUSSOLA A MANO SNODATE BOCCA POLIGONALE

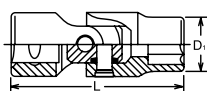



Koken articolo	pollici	D ₁ mm	L mm	
3445A-5/16	5/16"	12	47	1
3445A-3/8	3/8"	14	48	1
3445A-7/16	7/16"	15.8	49.5	1
3445A-1/2	1/2"	18.3	51	1
3445A-9/16	9/16"	19.5	51	1
3445A-5/8	5/8"	22	53.5	1
3445A-11/16	11/16"	24.5	54.5	1
3445A-3/4	3/4"	25.8	56.5	1

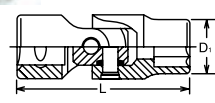

NUT GRIP® BLOCCADADI

CHIAVI A BUSSOLA A MANO SNODATE CON SFERE DI TENUTA BOCCA NUT GRIP





Koken articolo	mm	D ₁ mm	L mm	
3441M-8	8	12	46	1
3441M-10	10	14.5	46	1
3441M-11 <i>novità</i>	11	15.8	46.5	1
3441M-12	12	16.8	47	1
3441M-13	13	18	48	1
3441M-14	14	19.5	49.5	1
3441M-15 <i>novità</i>	15	21	50	1
3441M-16 <i>novità</i>	16	22	50	1
3441M-17 <i>novità</i>	17	23.5	51	1
3441M-18 <i>novità</i>	18	24.6	51.5	1
3441M-19 <i>novità</i>	19	26	52.5	1

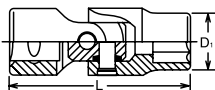

TORX®

CHIAVI A BUSSOLA A MANO SNODATE BOCCA TORX®



Koken articolo		D ₁ mm	L mm	
3440T-E 6	E 6	7.9	44.5	1
3440T-E 8	E 8	9.9	46	1
3440T-E10	E 10	11.8	47	1
3440T-E12	E 12	14.5	48.5	1
3440T-E14	E 14	15.7	49	1
3440T-E16	E 16	18	50	1
3440T-E18	E 18	19.5	53	1
3440T-E20	E 20	22	54	1

novità



NUT GRIP® BLOCCADADI

SERIE 5 PZ. CHIAVI A BUSSOLA A MANO SNODATE CON SFERE DI TENUTA BOCCA NUT GRIP



Koken articolo	mm	
RS 3441M/11	8, 10, 11, 12, 13, 14, 15, 16, 17, 18, 19	1

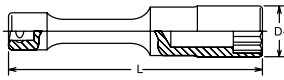

POLIGONALE



CHIAVI A BUSSOLA A MANO BOCCA
POLIGONALE TIPO LUNGO



Koken articolo	 mm	D ₁ mm	L mm	
3117M-125-10	10	14.5	125	1
3117M-125-11	11	16	125	1
3117M-125-12	12	17	125	1
3117M-125-13	13	18	125	1
3117M-125-14	14	19.5	125	1
3117M-125-17	17	23.5	125	1
3117M-125-19	19	25	125	1
3117M-125-21	21	27	125	1
3117M-125-22	22	29	125	1
3117M-250-10	10	14.5	250	1
3117M-250-11	11	16	250	1
3117M-250-12	12	17	250	1
3117M-250-13	13	18	250	1
3117M-250-14	14	19.5	250	1
3117M-250-17	17	23.5	250	1
3117M-250-19	19	25	250	1
3117M-250-21	21	27	250	1
3117M-250-22	22	29	250	1

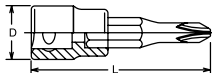

PHILLIPS®

CHIAVI A BUSSOLA A
CROCE PHILLIPS®





Koken articolo		D mm	L mm	
3000-60 (PH)-1	PH1	18	60	1
3000-60 (PH)-2	PH2	18	60	1
3000-60 (PH)-3	PH3	18	60	1
3000-60 (PH)-4	PH4	18	60	1

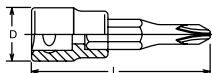

POZIDRIV®

CHIAVI A BUSSOLA A
CROCE POZIDRIV®





Koken articolo		D mm	L mm	
3000-50 (PZ)-1	PZ1	18	50	1
3000-50 (PZ)-2	PZ2	18	50	1
3000-50 (PZ)-3	PZ3	18	50	1

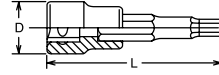

ESAGONO

CHIAVI A BUSSOLA
MASCHIO
ESAGONALE



Koken articolo	 mm	D mm	L mm	
3010M-38-3	3	18	38	1
3010M-38-4	4	18	38	1
3010M-38-5	5	18	38	1
3010M-38-6	6	18	38	1
3010M-38-7	7	18	38	1
3010M-38-8	8	18	38	1
3010M-38-9	9	20	38	1
3010M-38-10	10	20	38	1
3010M-38-11	11	20	38	1
3010M-38-12	12	20	38	1
3010M-38-13	13	22	38	1
3010M-38-14	14	22	38	1
3010M-62-3	3	18	62	1
3010M-62-4	4	18	62	1
3010M-62-5	5	18	62	1
3010M-62-6	6	18	62	1
3010M-62-7	7	18	62	1
3010M-62-8	8	18	62	1
3010M-62-9	9	20	62	1
3010M-62-10	10	20	62	1
3010M-62-11	11	20	62	1
3010M-62-12	12	20	62	1
3010M-62-13	13	22	62	1
3010M-62-14	14	22	62	1
3010M-100-3	3	18	100	1
3010M-100-4	4	18	100	1
3010M-100-5	5	18	100	1
3010M-100-6	6	18	100	1
3010M-100-7	7	18	100	1
3010M-100-8	8	18	100	1
3010M-100-9	9	20	100	1
3010M-100-10	10	20	100	1
3010M-100-11	11	20	100	1
3010M-100-12	12	20	100	1
3010M-100-13	13	22	100	1
3010M-100-14	14	22	100	1
3010M-160-3	3	18	160	1
3010M-160-4	4	18	160	1
3010M-160-5	5	18	160	1
3010M-160-6	6	18	160	1
3010M-160-7	7	18	160	1
3010M-160-8	8	18	160	1
3010M-160-9	9	20	160	1
3010M-160-10	10	20	160	1
3010M-160-11	11	20	160	1
3010M-160-12	12	20	160	1
3010M-160-13	13	22	160	1
3010M-160-14	14	22	160	1



POLLICI

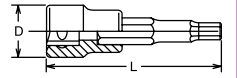

ESAGONO

CHIAVI A BUSSOLA
MASCHIO
ESAGONALE





Koken articolo	 pollici	D mm	L mm	
3010A-50-1/8	1/8"	18	50	1
3010A-50-5/32	5/32"	18	50	1
3010A-50-3/16	3/16"	18	50	1
3010A-50-7/32	7/32"	18	50	1
3010A-50-1/4	1/4"	18	50	1
3010A-50-9/32	9/32"	18	50	1
3010A-50-5/16	5/16"	18	50	1
3010A-50-11/32	11/32"	20	50	1
3010A-50-3/8	3/8"	20	50	1
3010A-50-7/16	7/16"	20	50	1
3010A-50-1/2	1/2"	22	50	1





ESAGONO

SERIE 8 PZ. CHIAVI A BUSSOLA
MASCHIO ESAGONALE

Koken articolo		L mm	
RS 3010M-38/8	3, 4, 5, 6, 7, 8, 10, 12 mm	38	1
RS 3010M-62/8	3, 4, 5, 6, 7, 8, 10, 12 mm	62	1
RS 3010M-100/8	3, 4, 5, 6, 7, 8, 10, 12 mm	100	1
RS 3010A-50/8	1/8", 5/32", 3/16", 7/32", 1/4", 5/16", 3/8", 1/2"	50	1

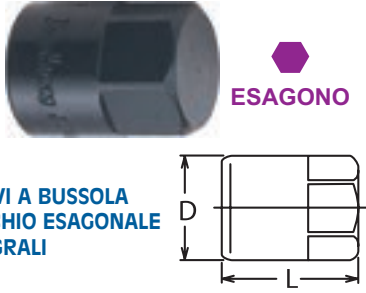
POLLICI



ESAGONO

CHIAVI A BUSSOLA MASCHIO ESAGONALE INTEGRALI

Koken articolo	mm	D mm	L mm	
3012M-25-3	3	18.5	25	1
3012M-25-4	4	18.5	25	1
3012M-25-5	5	18.5	25	1
3012M-25-6	6	18.5	25	1
3012M-25-7	7	18.5	25	1
3012M-25-8	8	18.5	25	1
3012M-25-10	10	18.5	25	1
3012M-25-12	12	19	25	1
3012M-25-14	14	19	25	1
3012M-25-17	17	19	25	1

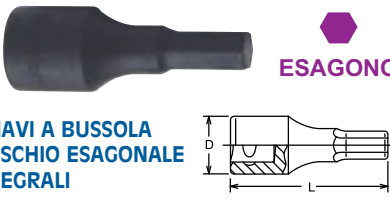

ESAGONO

CHIAVI A BUSSOLA MASCHIO ESAGONALE INTEGRALI

Koken articolo	mm	D mm	L mm	
3012M-52-3	3	18	52	1
3012M-52-4	4	18	52	1
3012M-52-5	5	18	52	1
3012M-52-6	6	18	52	1
3012M-52-7	7	18	52	1
3012M-52-8	8	18.5	52	1
3012M-52-9	9	18.5	52	1
3012M-52-10	10	20	52	1
3012M-52-11	11	20	52	1
3012M-52-12	12	20	52	1
3012M-52-13	13	20	52	1
3012M-52-14	14	20	52	1



POLLICI

ESAGONO

CHIAVI A BUSSOLA MASCHIO ESAGONALE INTEGRALI

Koken articolo	pollici	D mm	L mm	
3012A-52-1/8	1/8"	18	52	1
3012A-52-5/32	5/32"	18	52	1
3012A-52-3/16	3/16"	18	52	1
3012A-52-7/32	7/32"	18	52	1
3012A-52-1/4	1/4"	18	52	1
3012A-52-9/32	9/32"	18	52	1
3012A-52-5/16	5/16"	18.5	52	1
3012A-52-11/32	11/32"	18.5	52	1
3012A-52-3/8	3/8"	20	52	1
3012A-52-7/16	7/16"	20	52	1
3012A-52-1/2	1/2"	20	52	1
3012A-52-9/16	9/16"	20	52	1



TAGLIO

CHIAVI A BUSSOLA A TAGLIO

Koken articolo	mm	D mm	L mm	
3005-60-5	1.0x5.5	18	60	1
3005-60-8	1.2x8	18	60	1
3005-60-10	1.6x10	20	60	1

3012M-62-3	3	18	62	1
3012M-62-4	4	18	62	1
3012M-62-5	5	18	62	1
3012M-62-6	6	18	62	1
3012M-62-7	7	18	62	1
3012M-62-8	8	18.5	62	1
3012M-62-9	9	18.5	62	1
3012M-62-10	10	20	62	1
3012M-62-11	11	20	62	1
3012M-62-12	12	20	62	1
3012M-62-13	13	20	62	1
3012M-62-14	14	20	62	1
3012M-75-3	3	18	75	1
3012M-75-4	4	18	75	1
3012M-75-5	5	18	75	1
3012M-75-6	6	18	75	1
3012M-75-7	7	18	75	1
3012M-75-8	8	18.5	75	1
3012M-75-9	9	18.5	75	1
3012M-75-10	10	20	75	1
3012M-75-11	11	20	75	1
3012M-75-12	12	20	75	1
3012M-75-13	13	20	75	1
3012M-75-14	14	20	75	1

3012A-62-1/8	1/8"	18	62	1
3012A-62-5/32	5/32"	18	62	1
3012A-62-3/16	3/16"	18	62	1
3012A-62-7/32	7/32"	18	62	1
3012A-62-1/4	1/4"	18	62	1
3012A-62-9/32	9/32"	18	62	1
3012A-62-5/16	5/16"	18.5	62	1
3012A-62-11/32	11/32"	18.5	62	1
3012A-62-3/8	3/8"	20	62	1
3012A-62-7/16	7/16"	20	62	1
3012A-62-1/2	1/2"	20	62	1
3012A-62-9/16	9/16"	20	62	1
3012A-75-1/8	1/8"	18	75	1
3012A-75-5/32	5/32"	18	75	1
3012A-75-3/16	3/16"	18	75	1
3012A-75-7/32	7/32"	18	75	1
3012A-75-1/4	1/4"	18	75	1
3012A-75-9/32	9/32"	18	75	1
3012A-75-5/16	5/16"	18.5	75	1
3012A-75-11/32	11/32"	18.5	75	1
3012A-75-3/8	3/8"	20	75	1
3012A-75-7/16	7/16"	20	75	1
3012A-75-1/2	1/2"	20	75	1
3012A-75-9/16	9/16"	20	75	1



ESAGONO

SERIE 8 PZ. CHIAVI A BUSSOLA MASCHIO ESAGONALE

Koken articolo	mm	L mm	
RS 3012M-52/8	3, 4, 5, 6, 7, 8, 10, 12 mm	52	1
RS 3012A-52/8	1/8", 5/32", 3/16", 7/32", 1/4", 5/16", 3/8", 1/2"	52	1

POLLICI





KOKEN 3/8"

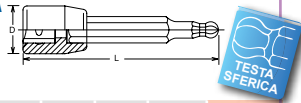

ESAGONO

CHIAVI A BUSSOLA
TESTA SFERICA
MASCHIO
ESAGONALE



Koken articolo	mm	D mm	L mm	
3011M-62-3	3	18	62	1
3011M-62-4	4	18	62	1
3011M-62-5	5	18	62	1
3011M-62-6	6	18	62	1
3011M-62-7	7	18	62	1
3011M-62-8	8	18	62	1
3011M-62-10	10	20	62	1
3011M-62-12	12	20	62	1
3011M-100-3	3	18	100	1
3011M-100-4	4	18	100	1
3011M-100-5	5	18	100	1
3011M-100-6	6	18	100	1
3011M-100-7	7	18	100	1
3011M-100-8	8	18	100	1
3011M-100-10 <small>novità</small>	10	20	100	1
3011M-120-3	3	18	120	1
3011M-120-4	4	18	120	1
3011M-120-5	5	18	120	1
3011M-120-6	6	18	120	1
3011M-120-7	7	18	120	1
3011M-120-8	8	18	120	1
3011M-160-3	3	18	160	1
3011M-160-4	4	18	160	1
3011M-160-5	5	18	160	1
3011M-160-6	6	18	160	1
3011M-160-7	7	18	160	1
3011M-160-8	8	18	160	1



ESAGONO



CHIAVI A BUSSOLA
MASCHIO
ESAGONALE CON
ANELLO DI TENUTA

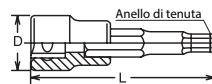



Koken articolo	mm	D mm	L mm	
3015M-62-3	3	18	62	1
3015M-62-4	4	18	62	1
3015M-62-5	5	18	62	1
3015M-62-6	6	18	62	1
3015M-62-7	7	18	62	1
3015M-62-8	8	18	62	1
3015M-62-10	10	20	62	1
3015M-62-12	12	20	62	1
3015M-100-3	3	18	100	1
3015M-100-4	4	18	100	1
3015M-100-5	5	18	100	1
3015M-100-6	6	18	100	1
3015M-100-7	7	18	100	1
3015M-100-8	8	18	100	1
3015M-100-10	10	20	100	1
3015M-100-12	12	20	100	1

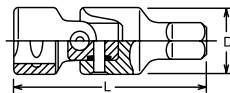

ESAGONO

CHIAVI A BUSSOLA A
MANO SNODATE
MASCHIO ESAGONALE





Koken articolo	mm	D ₁	L mm	
3430M-5	5	19	62	1
3430M-6	6	19	62	1
3430M-7	7	19	62	1
3430M-8	8	19	62	1
3430M-10	10	19	62	1
3430M-12	12	19	62	1

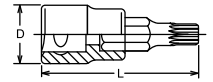

XZN

CHIAVI A BUSSOLA
MASCHIO XZN



Koken articolo		D mm	L mm	
3020-38-M 5	M 5	18	38	1
3020-38-M 6	M 6	18	38	1
3020-38-M 8	M 8	18	38	1
3020-38-M10	M10	20	38	1
3020-38-M12	M12	20	38	1
3020-38-M14	M14	22	38	1
3020-50-M 4	M 4	18	50	1
3020-50-M 5	M 5	18	50	1
3020-50-M 6	M 6	18	50	1
3020-50-M 8	M 8	18	50	1
3020-50-M10	M10	20	50	1
3020-50-M12	M12	20	50	1
3020-50-M14	M14	22	50	1
3020-100-M 4	M 4	18	100	1
3020-100-M 5	M 5	18	100	1
3020-100-M 6	M 6	18	100	1
3020-100-M 8	M 8	18	100	1
3020-100-M10	M10	20	100	1
3020-100-M12	M12	20	100	1
3020-100-M14	M14	22	100	1
3020-120-M 4	M 4	18	120	1
3020-120-M 5	M 5	18	120	1
3020-120-M 6	M 6	18	120	1
3020-120-M 8	M 8	18	120	1
3020-120-M10	M10	20	120	1
3020-120-M12	M12	20	120	1
3020-120-M14	M14	22	120	1

XZN



S

S

	S mm	S mm
M 4	3,60	M12 11,50
M 5	4,80	M14 13,30
M 6	6,10	M16 15,70
M 8	7,30	M18 16,90
M10	9,70	





SERIE CHIAVI A BUSSOLA XZN

Koken articolo	NR CHIAVI		L mm	
RS 3020/6-L38	6	M5, M6, M8, M10, M12, M14	38	1
RS 3020/7-L50	7	M4, M5, M6, M8, M10, M12, M14	50	1

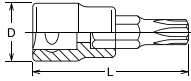

CHIAVI A BUSSOLA MASCHIO TORX®



Koken articolo	TORX	D mm	L mm	
3025-38-T8	TX 8	18	38	1
3025-38-T9	TX 9	18	38	1
3025-38-T10	TX 10	18	38	1
3025-38-T15	TX 15	18	38	1
3025-38-T20	TX 20	18	38	1
3025-38-T25	TX 25	18	38	1
3025-38-T27	TX 27	18	38	1
3025-38-T30	TX 30	18	38	1
3025-38-T40	TX 40	18	38	1
3025-38-T45	TX 45	18	38	1
3025-38-T50	TX 50	20	38	1
3025-38-T55	TX 55	20	38	1
3025-50-T8	TX 8	18	50	1
3025-50-T9	TX 9	18	50	1
3025-50-T10	TX 10	18	50	1
3025-50-T15	TX 15	18	50	1
3025-50-T20	TX 20	18	50	1
3025-50-T25	TX 25	18	50	1
3025-50-T27	TX 27	18	50	1
3025-50-T30	TX 30	18	50	1
3025-50-T35	TX 35	18	50	1
3025-50-T40	TX 40	18	50	1
3025-50-T45	TX 45	18	50	1
3025-50-T50	TX 50	20	50	1
3025-50-T55	TX 55	20	50	1
3025-140-T9	TX 9	18	140	1
3025-140-T10	TX 10	18	140	1
3025-140-T15	TX 15	18	140	1
3025-140-T20	TX 20	18	140	1
3025-140-T25	TX 25	18	140	1
3025-140-T27	TX 27	18	140	1
3025-140-T30	TX 30	18	140	1
3025-140-T40	TX 40	18	140	1
3025-140-T45	TX 45	18	140	1
3025-140-T50	TX 50	20	140	1
3025-140-T55	TX 55	20	140	1





SERIE 8 PZ. CHIAVI A BUSSOLA MASCHIO TORX®

Koken articolo	TORX	L mm	
RS 3025/8-38	TX10, TX15, TX20, TX25, TX27, TX30, TX40, TX45	38	1
RS 3025/8-50	TX10, TX15, TX20, TX25, TX27, TX30, TX40, TX45	50	1
novità RS 3025/8-140 KE	TX20, TX25, TX27, TX30, TX40, TX45, TX50, TX55	140	1

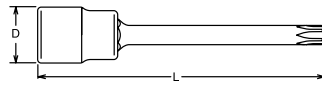

CHIAVI A BUSSOLA MASCHIO TORX®





Koken articolo	TORX	D mm	L mm	
3025-100R-T20	TX 20	18	100	1
3025-100R-T25	TX 25	18	100	1
3025-100R-T27	TX 27	18	100	1
3025-100R-T30	TX 30	18	100	1
3025-100R-T40	TX 40	18	100	1
3025-100R-T45	TX 45	18	100	1
3025-100R-T50	TX 50	20	100	1
3025-100R-T55	TX 55	20	100	1

Albero rotondo per facilitare l'accesso agli spazi stretti.

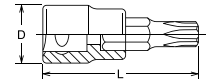

CHIAVI A BUSSOLA MASCHIO TORX® CON FORO



Koken articolo	TORX	D mm	L mm	
3025-50-T10H	TH 10	18	50	1
3025-50-T15H	TH 15	18	50	1
3025-50-T20H	TH 20	18	50	1
3025-50-T25H	TH 25	18	50	1
3025-50-T27H	TH 27	18	50	1
3025-50-T30H	TH 30	18	50	1
3025-50-T40H	TH 40	18	50	1
3025-50-T45H	TH 45	18	50	1
3025-50-T50H	TH 50	20	50	1
3025-50-T55H	TH 55	20	50	1
3025-160-T25H	TH 25	18	160	1
3025-160-T27H	TH 27	18	160	1
3025-160-T30H	TH 30	18	160	1
3025-160-T40H	TH 40	18	160	1
3025-160-T45H	TH 45	18	160	1
3025-160-T50H	TH 50	20	160	1
3025-160-T55H	TH 55	20	160	1



SERIE 4 PZ. CHIAVI A BUSSOLA MASCHIO TORX CON FORO L 160 PER SISTEMI ANTIMANOMISSIONE

Koken articolo	TORX	
3247	TH27, TH30, TH40, TH50	1

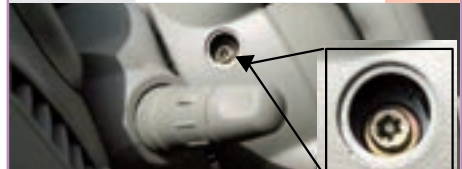

Per riparazioni Airbag

TORX®	S mm	S mm	
T 6	1.70	T 40	6.70
T 7	2.00	T 45	7.90
T 8	2.30	T 50	8.90
T 9	2.50	T 55	11.30
T 10	2.70	T 60	13.30
T 15	3.30	T 70	15.60
T 20	3.90	T 80	17.60
T 25	4.50	T 90	20.00
T 27	5.00	T 100	22.20
T 30	5.60		





TORX[®] CON FORO

CHIAVI A BUSSOLA MASCHIO TORX[®] CON FORO

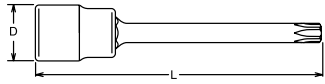

Koken articolo	Icona	D mm	L mm	Box
3025-100R-T20H	TH 20	18	100	1
3025-100R-T25H	TH 25	18	100	1
3025-100R-T27H	TH 27	18	100	1
3025-100R-T30H	TH 30	18	100	1
3025-100R-T40H	TH 40	18	100	1
3025-100R-T45H	TH 45	18	100	1
3025-100R-T50H	TH 50	20	100	1
3025-100R-T55H	TH 55	20	100	1

Albero rotondo per facilitare l'accesso agli spazi stretti.



TORXplus[®]

CHIAVI A BUSSOLA MASCHIO TORX PLUS[®]

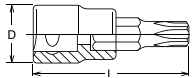

Koken articolo	Icona	D mm	L mm	Box
3025-50-10IP	10IP	18	50	1
3025-50-15IP	15IP	18	50	1
3025-50-20IP	20IP	18	50	1
3025-50-25IP	25IP	18	50	1
3025-50-27IP	27IP	18	50	1
3025-50-30IP	30IP	18	50	1
3025-50-40IP	40IP	18	50	1
3025-50-45IP	45IP	18	50	1
3025-50-50IP	50IP	20	50	1
3025-50-55IP	55IP	20	50	1

TORXplus [®]	S mm	S mm	
8 IP	2.30	30 IP	5.60
9 IP	2.50	40 IP	6.70
10 IP	2.70	45 IP	7.90
15 IP	3.30	50 IP	8.90
20 IP	3.90	55 IP	11.30
25 IP	4.50	60 IP	13.30
27 IP	5.00		



TORXplus[®] CON FORO

CHIAVI A BUSSOLA MASCHIO TORX PLUS[®] CON FORO

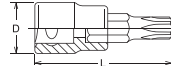

Koken articolo	Icona	D mm	L mm	Box
3025-50-10 IPR	10 IPR	18	50	1
3025-50-15 IPR	15 IPR	18	50	1
3025-50-20 IPR	20 IPR	18	50	1
3025-50-25 IPR	25 IPR	18	50	1
3025-50-27 IPR	27 IPR	18	50	1
3025-50-30 IPR	30 IPR	18	50	1
3025-50-40 IPR	40 IPR	18	50	1
3025-50-45 IPR	45 IPR	18	50	1
3025-50-50 IPR	50 IPR	20	50	1
3025-50-55 IPR	55 IPR	20	50	1



SERIE 9 PZ. CHIAVI A BUSSOLA MASCHIO TORX PLUS[®] CON FORO
MISURE: 10IPR, 15IPR, 20IPR, 25IPR, 27IPR, 30IPR, 40IPR, 45IPR, 50IPR

Koken articolo	Icona	L mm	Box
10 IPR, 15 IPR, 20 IPR, 25 IPR, 27 IPR, 30 IPR, 40 IPR, 45 IPR, 50 IPR		50	1



TORXplus[®] CON FORO

SERIE 11 PZ. CHIAVI A BUSSOLA MASCHIO TORX PLUS[®] CON FORO

Koken articolo	Icona	Box
RSX 025/11-IPR		1

CONTENUTO

- 1/4" 2025-28 IPR 8 IPR, 10 IPR, 15 IPR, 20 IPR, 25 IPR, 27 IPR, 30 IPR
- 3/8" 3025-50 IPR 40 IPR, 45 IPR, 50 IPR, 55 IPR

TORXplus [®] CON FORO	S mm	S mm	
8 IPR	2.20	27 IPR	4.70
9 IPR	2.40	30 IPR	5.20
10 IPR	2.60	40 IPR	6.30
15 IPR	3.10	45 IPR	7.40
20 IPR	3.60	50 IPR	8.40
25 IPR	4.10	55 IPR	10.60



RIBE

CHIAVI A BUSSOLA MASCHIO RIBE

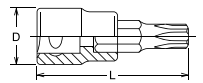

Koken articolo	Icona	D mm	L mm	Box
3027-50-M5	M 5	18	50	1
3027-50-M6	M 6	18	50	1
3027-50-M7	M 7	18	50	1
3027-50-M8	M 8	18	50	1
3027-50-M9	M 9	20	50	1
3027-50-M10	M10	20	50	1
3027-50-M12	M12	20	50	1
3027-100-M5	M 5	18	100	1
3027-100-M6	M 6	18	100	1
3027-100-M8	M 8	18	100	1
3027-100-M10	M10	18	100	1
3027-100-M12	M12	18	100	1

RIBE	S mm	W mm
M 5	5.00	1.20
M 6	6.00	1.30
M 7	7.00	1.40
M 8	8.00	1.80
M 9	9.00	2.00
M 10	10.00	2.30
M 12	12.00	2.60
M 13	13.00	3.10
M 14	14.00	3.20
M 16	16.00	3.60



SERIE 5 PZ. CHIAVI A BUSSOLA RIBE
MISURE: M5, M6, M8, M10, M12,

Koken articolo	Icona	L mm	Box
RS 3027/5-L50	M5, M6, M8, M10, M12,	50	1

KOKEN 3/8"

novità



QUADRO

CHIAVI A BUSSOLA MASCHIO QUADRO

Koken articolo	mm	D mm	L mm	
3110M-6	6	18	28	1
3110M-8	8	18	28	1
3110M-10	10	18	28	1
3110M-12	12	18	28	1

POLLICI



QUADRO

CHIAVI A BUSSOLA MASCHIO QUADRO

Koken articolo	mm	D mm	L mm	
3110A-5/16	5/16	18	28	1
3110A-3/8	3/8	18	28	1
3110A-1/2	1/2	18	28	1



MECCANISMO 24 DENTI



CRICCHETTO PORTABUSSOLA REVERSIBILE

Koken articolo	D mm	T mm	L mm	
2749 PS-3/8	25	21,9	75	1

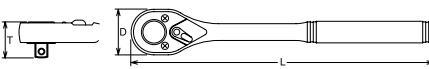
CRICCHETTO PORTABUSSOLA REVERSIBILE

Koken articolo	D mm	T mm	L mm	
2749 P-3/8	25	21,9	125	1



MECCANISMO 24 DENTI



CRICCHETTO PORTABUSSOLA REVERSIBILE

Koken articolo	D mm	T mm	L mm	
3749 S	34	24,8	110	1



MECCANISMO 24 DENTI



CRICCHETTO PORTABUSSOLA REVERSIBILE CON PULSANTE DI SBLOCCAGGIO RAPIDO

Koken articolo	D mm	T mm	L mm	
3749 SB	34	24,8	110	1



MECCANISMO 24 DENTI



CRICCHETTO PORTABUSSOLA REVERSIBILE

Koken articolo	D mm	T mm	L mm	
3752 J	33	34,3	200	1



MECCANISMO 24 DENTI



CRICCHETTO PORTABUSSOLA REVERSIBILE MULTIFUNZIONE

Koken articolo	D mm	T mm	L mm	
3753 SM	30,5	26,4	81	1



MECCANISMO 24 DENTI



CRICCHETTO PORTABUSSOLA REVERSIBILE MULTIFUNZIONE CON PULSANTE DI SBLOCCAGGIO RAPIDO

Koken articolo	D mm	T mm	L mm	
3753 SMB	30,5	26,4	81	1



MECCANISMO 24 DENTI



CRICCHETTO PORTABUSSOLA REVERSIBILE

Koken articolo	D mm	T mm	L mm	
3753 J	30,5	26,4	200	1



MECCANISMO 24 DENTI



CRICCHETTO PORTABUSSOLA REVERSIBILE

Koken articolo	D mm	T mm	L mm	
3753 P	30,5	26,4	200	1
3753 P-250	30,5	26,4	250	1



MECCANISMO 24 DENTI



CRICCHETTO PORTABUSSOLA REVERSIBILE CON PULSANTE DI SBLOCCAGGIO RAPIDO

Koken articolo	D mm	T mm	L mm	
3753 JB	30,5	26,4	200	1



MECCANISMO 24 DENTI

CRICCHETTO PORTABUSSOLA REVERSIBILE CON PULSANTE DI SBLOCCAGGIO RAPIDO

Koken articolo	D mm	T mm	L mm	
3753 PB	30,5	26,4	200	1



MECCANISMO 24 DENTI

CRICCHETTO PORTABUSSOLA REVERSIBILE SNODATO

Koken articolo	D mm	T mm	L mm	
3774 P	30,5	26,4	265	1



MECCANISMO 24 DENTI

CRICCHETTO PORTABUSSOLA REVERSIBILE SNODATO CON PULSANTE DI BLOCCAGGIO TESTA E PULSANTE DI SBLOCCAGGIO RAPIDO

Koken articolo	D mm	T mm	L mm	
3774 JBL	30,5	26,4	285	1



MECCANISMO 24 DENTI

CRICCHETTO PORTABUSSOLA REVERSIBILE SNODATO

Koken articolo	D mm	T mm	L mm	
2774 JS-3/8	25	21,9	120	1



MECCANISMO 24 DENTI

CRICCHETTO PORTABUSSOLA REVERSIBILE SNODATO CON PULSANTE DI SBLOCCAGGIO RAPIDO

Koken articolo	D mm	T mm	L mm	
3774 JB	30,5	26,4	285	1



MECCANISMO 45 DENTI

CRICCHETTO PORTABUSSOLA REVERSIBILE CON TESTA GIREVOLE

Koken articolo	D mm	T mm	L mm	
3776 J	44	34,3	280	1



MECCANISMO 24 DENTI

CRICCHETTO PORTABUSSOLA REVERSIBILE SNODATO

Koken articolo	D mm	T mm	L mm	
2774 PS-3/8	25	21,9	120	1



MECCANISMO 24 DENTI

CRICCHETTO PORTABUSSOLA REVERSIBILE SNODATO CON PULSANTE DI SBLOCCAGGIO RAPIDO

Koken articolo	D mm	T mm	L mm	
3774 PB	30,5	26,4	285	1



MECCANISMO 45 DENTI

CRICCHETTO PORTABUSSOLA REVERSIBILE CON TESTA GIREVOLE

Koken articolo	D mm	T mm	L mm	
3776 P	44	34,3	280	1



MECCANISMO 24 DENTI

CRICCHETTO PORTABUSSOLA REVERSIBILE SNODATO

Koken articolo	D mm	T mm	L mm	
3774 PS	30,5	26,4	175	1



MECCANISMO 24 DENTI

CRICCHETTO PORTABUSSOLA REVERSIBILE SNODATO CON PULSANTE DI BLOCCAGGIO TESTA

Koken articolo	D mm	T mm	L mm	
3774 JL	30,5	26,4	285	1



MECCANISMO 24 DENTI

CRICCHETTO PORTABUSSOLA REVERSIBILE SNODATO

Koken articolo	D mm	T mm	L mm	
3774 J	30,5	26,4	175	1



MECCANISMO 24 DENTI

CRICCHETTO PORTABUSSOLA REVERSIBILE SNODATO CON PULSANTE DI BLOCCAGGIO TESTA

Koken articolo	D mm	T mm	L mm	
3774 PL	30,5	26,4	265	1



MECCANISMO 24 DENTI

CRICCHETTO PORTABUSSOLA REVERSIBILE SNODATO DISASSATO

Koken articolo	D mm	T mm	L mm	
3774 P-SR	30,5	26,4	310	1

KOKEN 3/8"



MECCANISMO 45 DENTI

ADATTATORE A CRICCHETTO REVERSIBILE SX/DX

Koken articolo	D mm	L mm	
3755 K	30,5	55	1



ADATTATORE DINAMOMETRICO

Koken articolo	Nm	L mm	
3701-20 NM	20	75	1
3701-30 NM	30	75	1



ADATTATORE A MANOPOLA PORTABUSSOLA

SFERA

Koken articolo	D mm	L mm	
3756	35	26	1



MECCANISMO 45 DENTI

ADATTATORE A MANOPOLA PORTABUSSOLA CON CRICCHETTO REVERSIBILE SX/DX

Koken articolo	D mm	L mm	
3757	50	35	1

Cod. 3756 - 3757

- Ideale per lavorare in spazi ristretti.
- La zigrinatura dell'anello esterno aumenta la presa.
- Indicatori sulla testa per identificare direzione dx/sx

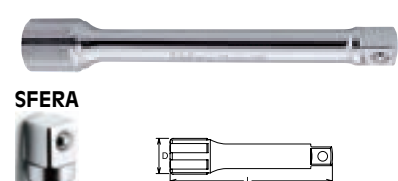

SFERA

PROLUNGA

Koken articolo	D mm	L mm	
3760-32	18	32	1
3760-50	18	50	1
3760-75	18	75	1
3760-125	18	125	1
3760-150	18	150	1
3760-250	18	250	1
3760-300	18	300	1
3760-400	18	400	1
3760-500	18	500	1
3760-600	18	600	1
3760-900	18	900	1
3760-1000	18	1000	1



Koken articolo

DESCRIZIONE

PK 3760/6 Set 6 prolunghine con attacco quadro

CARATTERISTICHE

3760   32, 50, 75, 125, 150, 250 mm

FLEX

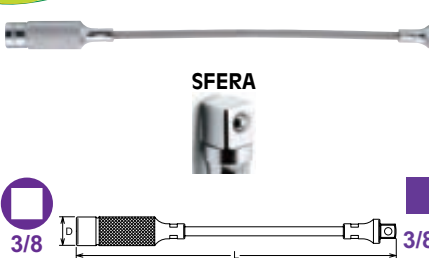

SFERA

PROLUNGA FLESSIBILE

Koken articolo	D mm	L mm	
3762	19,3	300	1



TESTA SFERICA

PROLUNGA CON TESTA SFERICA SISTEMA WOBBLE-FIX CON DUE MODALITÀ DI UTILIZZO:

Wobble

Fix

- PROLUNGA TESTA SFERICA ANGOLO 15°

- PROLUNGA TRADIZIONALE

Koken articolo	D mm	L mm	
3763-32	18	32	1
3763-50	18	50	1
3763-75	18	75	1
3763-125	18	125	1
3763-150	18	150	1
3763-250	18	250	1
3763-300	18	300	1



TESTA SFERICA

SISTEMA WOBBLE-FIX CON DUE MODALITÀ DI UTILIZZO:

Wobble

Fix

- PROLUNGA TESTA SFERICA ANGOLO 15°

- PROLUNGA TRADIZIONALE

Koken articolo	DESCRIZIONE
PK 3763/6	Set 6 prolunghine con attacco quadro

CARATTERISTICHE

3763   32, 50, 75, 125, 150, 250 mm



QUADRO MASCHIO SNODATO CON IMPUGNATURA

Koken articolo	D mm	L mm	
3768 J-250	20,5	250	1

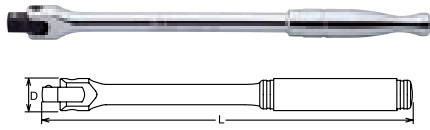

**QUADRO MASCHIO SNODATO CON
IMPUGNATURA IN METALLO**

Kokken articolo	D mm	L mm	
3768 P-250	20,5	250	1
3768 P-380	20,5	380	1



SFERA

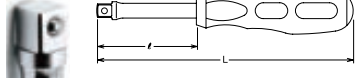

QUADRO MASCHIO CON IMPUGNATURA

Kokken articolo	ℓ mm	L mm	
3769 N-160	50	160	1
3769 N-230	120	230	1

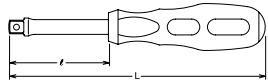

**QUADRO MASCHIO CON IMPUGNATURA
A TESTA SFERICA**

**SISTEMA WOBBLE-FIX
CON DUE MODALITÀ DI
UTILIZZO:**

- PROLUNGA TESTA SFERICA ANGOLO 15°
- PROLUNGA TRADIZIONALE

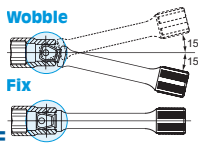

Kokken articolo	ℓ mm	L mm	
3769 NWF-160	50	160	1
3769 NWF-230	120	230	1

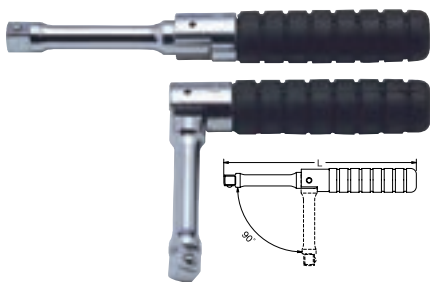

**QUADRO MASCHIO PIEGHEVOLE 90°
CON IMPUGNATURA**

Kokken articolo	L mm	
3769 H	170	1



SFERA

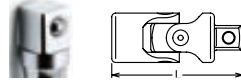

SNODO

Kokken articolo	L mm	
3770	50	1



SFERA

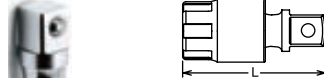

SNODO

Kokken articolo	L mm	
3771	43	1



SFERA



QUADRO MASCHIO CON MANOVELLA

Kokken articolo	H mm	L mm	
3780	100	400	1

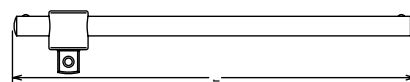

L'innovativa barra a forma ovale offre una maggiore durata e impedisce al quadro scorrevole di ruotare attorno l'asta.



QUADRO MASCHIO CON ASTA SCORREVOLE

Kokken articolo	L mm	
3785	200	1

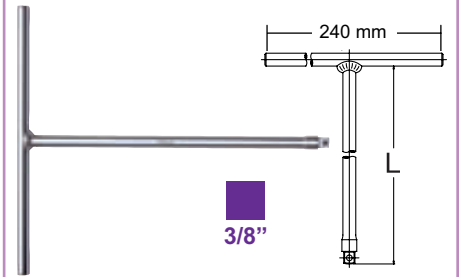

**CHIAVI A "T" MASCHIO QUADRO 3/8"
LARGHEZZA IMPUGNATURA 240 MM**

Kokken articolo	pollici	L mm	
3715 S-3/8	3/8"	268	1

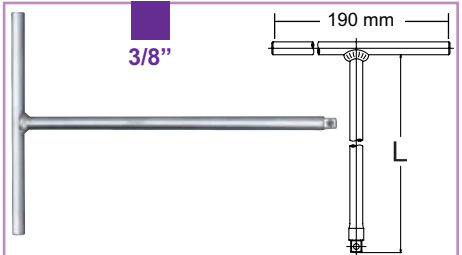

**CHIAVI A "T" MASCHIO QUADRO 3/8"
LARGHEZZA IMPUGNATURA 190 MM**

Kokken articolo	pollici	L mm	
3715 S-3/8	3/8"	268	1

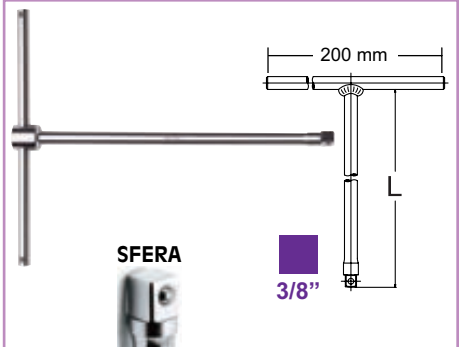

**CHIAVI A "T" MASCHIO QUADRO 3/8" CON
ASTA SCORREVOLE LARGHEZZA 200 MM**

Kokken articolo	pollici	L mm	
3715 SL-3/8	3/8"	237	1



CHIavi A "T" MASCHIO QUADRO 3/8" CON ASTA SCORREVOLE E CANOTTO DI ROTAZIONE LARGHEZZA 200 MM

Koken articolo	pollici	L mm	
3715 SLK-3/8	3/8"	236	1

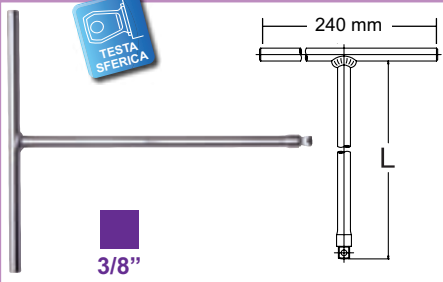



CHIavi A "T" MASCHIO QUADRO 3/8" TESTA SFERICA CON IMPUGNATURA LARGHEZZA 240 MM

Koken articolo	pollici	L mm	
3716-3/8	3/8"	268	1

RACCORDO DI RIDUZIONE MASCHIO/FEMMINA CON SFERA DI TENUTA NEL QUADRO MASCHIO

SFERA

F  M 

JAPAN

Koken articolo	F	M	L mm	
2233 A	1/4"	3/8"	22	1
3322 A	3/8"	1/4"	24	1
3344 A	3/8"	1/2"	35	1
4433 A-35	1/2"	3/8"	35	1
4433 A-75	1/2"	3/8"	75	1
4433 A-125	1/2"	3/8"	125	1
4433 A-250	1/2"	3/8"	250	1
4433 A-600	1/2"	3/8"	600	1
4466 A	1/2"	3/4"	42	1
6644 A	3/4"	1/2"	47	1
6688 A	3/4"	1"	60	1
8866 A	1"	3/4"	60	1



RIDUZIONI A SCOMPARSA CON SFERA NEL QUADRO MASCHIO

SFERA

Koken articolo	F	M	D mm	L mm	
3756 Z-1/2	3/8"	1/2"	28	29	1



SERIE 14 PZ. CHIAVI A BUSSOLA BOCCA ESAGONALE / POLIGONALE CASSETTA METALLICA 163 X 52 X H 33 MM





Koken articolo	DESCRIZIONE	
3217M-00	ESAGONO 9, 10, 11, 12, 13, 14, 15, 16, 17, 18, 19, 20, 21, 22 MM	1
3217M-05	POLIGONALE 9, 10, 11, 12, 13, 14, 15, 16, 17, 18, 19, 20, 21, 22 MM	1
3217M-10	SURFACE DRIVE 9, 10, 11, 12, 13, 14, 15, 16, 17, 18, 19, 20, 21, 22 MM	1





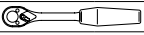



Koken articolo	DESCRIZIONE
ESH 3001	Cassetta metallica 17 Pz. 415 x 120 x h 50 mm
RICAMBI	
BUSSOLE	
 3410M	8, 9, 10, 11, 12, 13, 14, 15, 16, 17, 18, 19
3753J	
3763-125	
ACCESSORI	
3760-250	
3770	
3785	









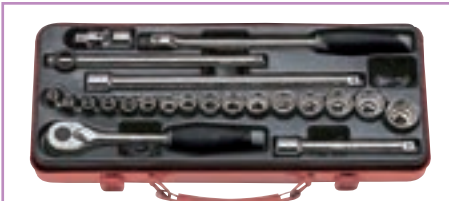

Koken articolo	DESCRIZIONE	
3250M-00	Cassetta metallica 17 Pz. 415 x 120 x h 50 mm	
RICAMBI		
BUSSOLE 	3400M	7, 8, 10, 11, 12 13, 14, 15, 16, 17 18, 19
ACCESSORI	3753J	
	3763-125	
	3760-250	
	3770	
3785		



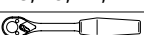

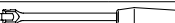



Koken articolo	DESCRIZIONE	
3250M-05	Cassetta metallica 17 Pz. 415 x 120 x h 50 mm	
RICAMBI		
BUSSOLE 	3405M	7, 8, 10, 11, 12 13, 14, 15, 16, 17 18, 19
ACCESSORI	3753J	
	3763-125	
	3760-250	
	3770	
3785		





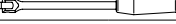



Koken articolo	DESCRIZIONE	
3210M-00	Cassetta metallica 22 Pz. 360 x 150 x h 50 mm	
RICAMBI		
BUSSOLE 	3400M	6, 7, 8, 9, 10, 11, 12 13, 14, 15, 16, 17 18, 19, 21, 22
ACCESSORI	3753J	
	3760-125	
	3760-250	
	3768J-250	
	3770	
3785		







Koken articolo	DESCRIZIONE	
3210M-05	Cassetta metallica 22 Pz. 360 x 150 x h 50 mm	
RICAMBI		
BUSSOLE 	3405M	6, 7, 8, 9, 10, 11, 12 13, 14, 15, 16, 17 18, 19, 21, 22
ACCESSORI	3753J	
	3760-125	
	3760-250	
	3768J-250	
	3770	
	3785	

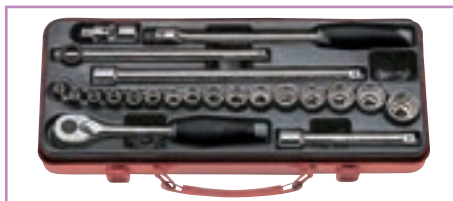

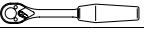

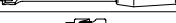

Koken articolo	DESCRIZIONE	
ETH 3001	Cassetta metallica 22 Pz. 310 x 86 x h 40 mm	
RICAMBI		
BUSSOLE 	3425 	E4, E5, E6, E7, E8
	4425 	E10, E11, E12, E14 E16, E18
BUSSOLE 	3025.50 	T10, T15, T20 T25, T27
	4025.60 	T30, T40, T45 T50, T55
ACCESSORI	4433A-35	

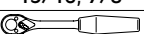

Koken articolo	DESCRIZIONE	
3210M-10	Cassetta metallica 22 Pz. 360 x 150 x h 50 mm	
RICAMBI		
BUSSOLE 	3410M	6, 7, 8, 9, 10, 11, 12, 13, 14, 15 16, 17, 18, 19, 21 22
ACCESSORI	3753J	
	3760-125	
	3760-250	
	3768J-250	
	3770	
3785		

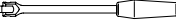
POLLICI

Koken articolo	DESCRIZIONE	
3210A-00	Cassetta metallica 22 Pz. 360 x 150 x h 50 mm	
RICAMBI		
BUSSOLE 	3400A	1/4, 5/16, 11/32 3/8, 7/16, 1/2, 9/16 5/8, 11/16, 3/4, 13/16, 7/8
ACCESSORI	3753J	
	3760-125	
	3760-250	
	3768J-250	
	3770	
3785		



**NUOVA SERIE Z KO-KEN
MADE IN JAPAN**

Progettata per soddisfare le crescenti esigenze del settore automotive dove si presentano design di motori più complessi e compatti.

KO-KEN ha studiato questa serie speciale di bussole con lunghezze e diametri ridotti ma mantenendo invariata l'eccellenza dei prodotti Made in Japan

Il design dei cricchetti a 72 denti permette di lavorare in modo efficiente in spazi ristretti e punti difficili da raggiungere senza rinunciare alla capacità di erogare una coppia elevata in spazi ristretti.



Koken articolo	mm	D ₁ mm	L mm	
3400MZ-5.5	5.5	8.5	19	1
3400MZ-6	6	9.1	19	1
3400MZ-7	7	10.3	19	1
3400MZ-8	8	11.5	20	1
3400MZ-10	10	14	20	1
3400MZ-11	11	15.3	21	1
3400MZ-12	12	16.5	21	1
3400MZ-13	13	17.8	21	1
3400MZ-14	14	19	21	1
3400MZ-15	15	20.2	21	1
3400MZ-16	16	21.3	21	1
3400MZ-17	17	22.5	21	1
3400MZ-18	18	23.6	22	1
3400MZ-19	19	24.8	22	1
3400MZ-21	21	27	23	1
3400MZ-22	22	28.3	23	1



Koken articolo	mm	D ₁ mm	L mm	
3300 XZ-7	7	10.3	35	1
3300 XZ-8	8	11.5	35	1
3300 XZ-10	10	14	35	1
3300 XZ-11	11	15.3	35	1
3300 XZ-12	12	16.5	35	1
3300 XZ-13	13	17.8	35	1
3300 XZ-14	14	19	35	1
3300 XZ-15	15	20.2	35	1
3300 XZ-16	16	21.3	35	1
3300 XZ-17	17	22.5	35	1
3300 XZ-18	18	23.6	35	1
3300 XZ-19	19	24.8	35	1



Koken articolo	mm	D mm	L mm	
3010 MZ-50-3	3	17	50	1
3010 MZ-50-4	4	17	50	1
3010 MZ-50-5	5	17	50	1
3010 MZ-50-6	6	17	50	1
3010 MZ-50-7	7	17	50	1
3010 MZ-50-8	8	17	50	1
3010 MZ-50-10	10	17	50	1
3010 MZ-50-12	12	19	50	1
3010 MZ-75-3	3	17	75	1
3010 MZ-75-4	4	17	75	1
3010 MZ-75-5	5	17	75	1
3010 MZ-75-6	6	17	75	1
3010 MZ-75-7	7	17	75	1
3010 MZ-75-8	8	17	75	1
3010 MZ-75-10	10	17	75	1
3010 MZ-75-12	12	19	75	1





Koken articolo	mm	D ₁ mm	L mm	
3441 MZ-8	8	12	41.5	1
3441 MZ-10	10	14.5	41.5	1
3441 MZ-12	12	16.8	42.5	1
3441 MZ-13	13	17.8	42.5	1
3441 MZ-14	14	19.5	44	1
3441 MZ-17	17	23.4	45.5	1

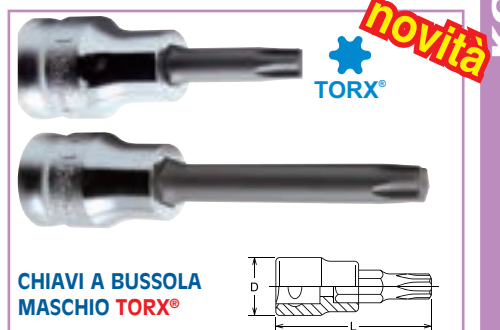

Koken articolo	mm	D ₁ mm	L mm	
3300 MZ-7	7	10.3	55	1
3300 MZ-8	8	11.5	55	1
3300 MZ-10	10	14	55	1
3300 MZ-11	11	15.3	55	1
3300 MZ-12	12	16.5	55	1
3300 MZ-13	13	17.8	55	1
3300 MZ-14	14	19	55	1
3300 MZ-15	15	20.2	55	1
3300 MZ-16	16	21.3	55	1
3300 MZ-17	17	22.5	55	1
3300 MZ-18	18	23.6	55	1
3300 MZ-19	19	24.8	55	1



Koken articolo		D mm	L mm	
3025 Z-50-T10	TX 10	17	50	1
3025 Z-50-T15	TX 15	17	50	1
3025 Z-50-T20	TX 20	17	50	1
3025 Z-50-T25	TX 25	17	50	1
3025 Z-50-T27	TX 27	17	50	1
3025 Z-50-T30	TX 30	17	50	1
3025 Z-50-T40	TX 40	17	50	1
3025 Z-50-T45	TX 45	17	50	1
3025 Z-50-T50	TX 50	17	50	1
3025 Z-50-T55	TX 55	19	50	1
3025 Z-75-T20	TX 20	17	75	1
3025 Z-75-T25	TX 25	17	75	1
3025 Z-75-T27	TX 27	17	75	1
3025 Z-75-T30	TX 30	17	75	1
3025 Z-75-T40	TX 40	17	75	1
3025 Z-75-T45	TX 45	17	75	1
3025 Z-75-T50	TX 50	17	75	1
3025 Z-75-T55	TX 55	19	75	1

KOKEN 3/8"

novità



MECCANISMO 72 DENTI

CRICCHETTO PORTABUSSOLA REVERSIBILE

Koken	D	T	L	
articolo	mm	mm	mm	
2725 Z-3/8	20,5	20,5	114	1

novità



MECCANISMO 72 DENTI

CRICCHETTO PORTABUSSOLA REVERSIBILE CON PULSANTE DI SBLOCCAGGIO RAPIDO

Koken	D	T	L	
articolo	mm	mm	mm	
2725 ZB-3/8	20,5	20,5	114	1

novità



MECCANISMO 72 DENTI

CRICCHETTO PORTABUSSOLA REVERSIBILE SNODATO

Koken	D	T	L	
articolo	mm	mm	mm	
2726 Z-3/8	20,5	20,5	114	1

novità



MECCANISMO 72 DENTI

CRICCHETTO PORTABUSSOLA REVERSIBILE

Koken	D	T	L	
articolo	mm	mm	mm	
2725 Z-3/8 (L160)	20,5	20,5	160	1

novità



MECCANISMO 72 DENTI

CRICCHETTO PORTABUSSOLA REVERSIBILE CON PULSANTE DI SBLOCCAGGIO RAPIDO

Koken	D	T	L	
articolo	mm	mm	mm	
2725 ZB-3/8 (L160)	20,5	20,5	160	1

novità



MECCANISMO 72 DENTI

CRICCHETTO PORTABUSSOLA REVERSIBILE SNODATO

Koken	D	T	L	
articolo	mm	mm	mm	
2726 Z-3/8 (L160)	20,5	20,5	160	1

novità



MECCANISMO 72 DENTI

CRICCHETTO PORTABUSSOLA REVERSIBILE

Koken	D	T	L	
articolo	mm	mm	mm	
3725 ZS	28	24,5	100	1

novità



MECCANISMO 72 DENTI

CRICCHETTO PORTABUSSOLA REVERSIBILE CON PULSANTE DI SBLOCCAGGIO RAPIDO

Koken	D	T	L	
articolo	mm	mm	mm	
3725 ZSB	28	24,5	100	1

novità



MECCANISMO 72 DENTI

CRICCHETTO PORTABUSSOLA REVERSIBILE SNODATO

Koken	D	T	L	
articolo	mm	mm	mm	
3726 ZS	28	24,5	120	1

novità



MECCANISMO 72 DENTI

CRICCHETTO PORTABUSSOLA REVERSIBILE

Koken	D	T	L	
articolo	mm	mm	mm	
3725 Z	28	24,5	178	1

novità



MECCANISMO 72 DENTI

CRICCHETTO PORTABUSSOLA REVERSIBILE CON PULSANTE DI SBLOCCAGGIO RAPIDO

Koken	D	T	L	
articolo	mm	mm	mm	
3725 ZB	28	24,5	178	1

novità



MECCANISMO 72 DENTI

CRICCHETTO PORTABUSSOLA REVERSIBILE SNODATO

Koken	D	T	L	
articolo	mm	mm	mm	
3726 Z	28	24,5	178	1

novità



MECCANISMO 72 DENTI

CRICCHETTO PORTABUSSOLA REVERSIBILE

Koken	D	T	L	
articolo	mm	mm	mm	
3725 Z-280	28	24,5	280	1

novità



MECCANISMO 24 DENTI

CRICCHETTO PORTABUSSOLA REVERSIBILE CON PULSANTE DI SBLOCCAGGIO RAPIDO

Koken	D	T	L	
articolo	mm	mm	mm	
3725 ZB-280	28	24,5	280	1

novità



CRICCHETTO PORTABUSSOLA REVERSIBILE SNODATO

Koken articolo	D mm	T mm	L mm	
3726 Z-280	28	24.5	280	1

novità



CRICCHETTO PORTABUSSOLA REVERSIBILE SNODATO CON PULSANTE DI SBLOCCAGGIO RAPIDO

Koken articolo	D mm	T mm	L mm	
3726 ZB	28	24.5	178	1

novità

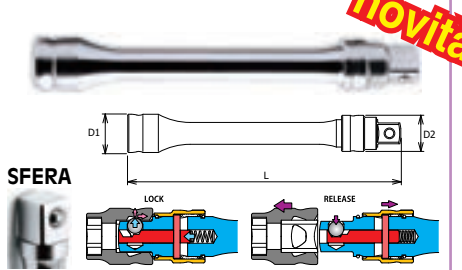

PROLUNGA CON SBLOCCAGGIO RAPIDO

Koken articolo	D1 mm	D2 mm	L mm	
3760 LZ-75	17.5	16.5	75	1
3760 LZ-125	17.5	16.5	125	1
3760 LZ-250	17.5	16.5	250	1

novità



CRICCHETTO PORTABUSSOLA REVERSIBILE SNODATO CON PULSANTE DI SBLOCCAGGIO RAPIDO

Koken articolo	D mm	T mm	L mm	
2726 ZB-3/8	20.5	20.5	114	1

novità



CRICCHETTO PORTABUSSOLA REVERSIBILE SNODATO CON PULSANTE DI SBLOCCAGGIO RAPIDO

Koken articolo	D mm	T mm	L mm	
3726 ZB-280	28	24.5	280	1

novità

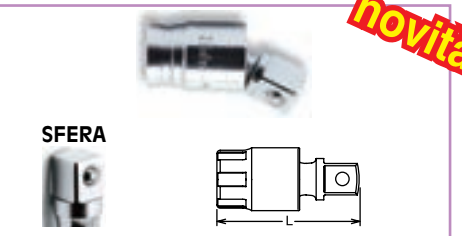

SFERA

SNODO

Koken articolo	L mm	
3771 Z	42.5	1

novità



CRICCHETTO PORTABUSSOLA REVERSIBILE SNODATO CON PULSANTE DI SBLOCCAGGIO RAPIDO

Koken articolo	D mm	T mm	L mm	
2726 ZB-3/8 (L160)	20.5	20.5	160	1

novità

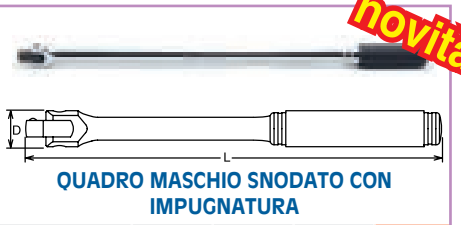

QUADRO MASCHIO SNODATO CON IMPUGNATURA

Koken articolo	D mm	L mm	
3768 Z-250	20,5	250	1
3768 Z-400	20,5	400	1

novità

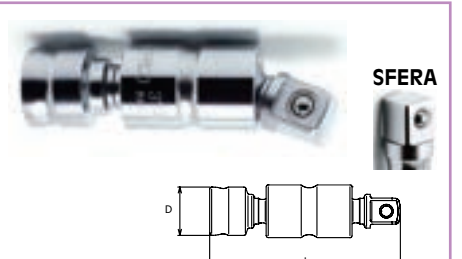

SFERA

DOPPIO SNODO

Koken articolo	D mm	L mm	
3772 Z	17	65	1

novità



CRICCHETTO PORTABUSSOLA REVERSIBILE SNODATO CON PULSANTE DI SBLOCCAGGIO RAPIDO

Koken articolo	D mm	T mm	L mm	
3726 ZSB	28	24.5	120	1

novità



SFERA

PROLUNGA

Koken articolo	D mm	L mm	
3760 Z-75	17.5	75	1
3760 Z-125	17.5	125	1
3760 Z-250	17.5	250	1

novità



SFERA

RACCORDO DI RIDUZIONE QUADRO FEMMINA 3/8" E MASCHIO 1/4"

Koken articolo	D mm	L mm	
3322 AZ-75	17.5	75	1

KOKEN 3/8"



3/8"



ESAGONO

BUSSOLE CHROM-VANADIUM - SATINATE

Attacco: 3/8"

impronta: ESAGONO

BGS articolo	mm	L mm	
3815-0060	6	28	1
3815-0070	7	28	1
3815-0080	8	28	1
3815-0090	9	28	1
BGS 10610	10	28	1
BGS 10611	11	28	1
BGS 10612	12	28	1
BGS 10613	13	28	1
BGS 10614	14	28	1
BGS 10615	15	28	1
BGS 10616	16	28	1
BGS 10617	17	28	1
BGS 10618	18	28	1
BGS 10619	19	28	1
3815-0200	20	28	1
3815-0210	21	28	1
3815-0220	22	28	1
3815-0240	24	28	1
BGS 10627	27	28	1



3/8"

SURFACE
DRIVE

PRO+

CV

**BUSSOLE CHROM-VANADIUM - SATINATE
SURFACE DRIVE**

Attacco: 3/8"

impronta: SURFACE-DRIVE

BGS articolo	mm	L mm	
BGS 2366	6	28	1
BGS 2367	7	28	1
BGS 2368	8	28	1
BGS 2369	9	28	1
BGS 2370	10	28	1
BGS 2371	11	28	1
BGS 2372	12	28	1
BGS 2373	13	28	1
BGS 2374	14	28	1
BGS 2375	15	28	1
BGS 2376	16	28	1
BGS 2377	17	28	1
BGS 2378	18	28	1
BGS 2379	19	28	1
BGS 2380	20	28	1
BGS 2381	21	28	1
BGS 2382	22	28	1
BGS 2384	24	28	1



3/8"





TORX®

BUSSOLE CHROM-VANADIUM - SATINATE

Attacco: 3/8"

impronta: TORX®

BGS articolo		L mm	
BGS 2710	E 4	28	1
BGS 2711	E 5	28	1
BGS 2712	E 6	28	1
BGS 2713	E 7	28	1
BGS 2714	E 8	28	1
BGS 6410	E 10	28	1
BGS 6411	E 11	28	1
BGS 6412	E 12	28	1
BGS 6414	E 14	28	1
BGS 6416	E 16	28	1
BGS 6417	E 18	28	1
BGS 2715	E 20	28	1

TORX®

S
mmS
mm

E 4

3.70

E 16

14.60

E 5

4.60

E 18

16.50

E 6

5.60

E 20

18.30

E 7

6.10

E 22

20.10

E 8

7.40

E 24

22.00

E 10

9.30

E 26

23.70

E 11

9.90

E 28

25.50

E 12

11.00

E 30

27.30

E 14

12.80

E 32

29.00

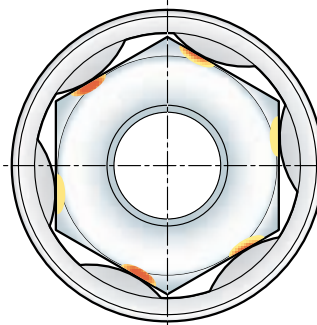

S

BUSSOLE SURFACE DRIVE

3/8"



POLIGONALE

1000 V

**CHIAVI A BUSSOLA A MANO BOCCA
POLIGONALE, ATTACCO 3/8"**

#FERMEC articolo	mm
FM 315-6	6
FM 315-7	7
FM 315-8	8
FM 315-9	9
FM 315-10	10
FM 315-11	11
FM 315-12	12
FM 315-13	13
FM 315-14	14
FM 315-15	15
FM 315-16	16
FM 315-17	17
FM 315-18	18
FM 315-19	19

CARATTERISTICHE

- IEC 60900
- 1000 V

**BUSSOLE
MULTIMPRONTA
SPLINE DRIVE**

3/8"

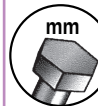
**MULTIMPRONTA
SPLINE DRIVE**

mm



Pollici



Torx®



XZN®

**BUSSOLE CHROM-VANADIUM
MULTIMPRONTA "SPLINE DRIVE"**

Attacco: 3/8"

impronta: SPLINE DRIVE

BGS articolo	mm	L mm	
BGS 10310	10	25	1
BGS 10311	11	25	1
BGS 10312	12	25	1
BGS 10313	13	25	1
BGS 10314	14	25	1
BGS 10315	15	25	1
BGS 10316	16	25	1
BGS 10317	17	25	1
BGS 10318	18	25	1
BGS 10319	19	25	1

POLLICI



3/8" **PRO+** **CV** **ESAGONO**

BGS articolo	DESCRIZIONE
BGS 9104	SERIE 12 PEZZI, BUSSOLE ESAGONALI 8-19 MM, ATT. 3/8"

CARATTERISTICHE

- misure: 8-9-10-11-12-13-14-15-16-17-18-19 mm
- finitura cromata satinata
- zigrinate
- su guida metallica
- peso: 500 g

POLLICI



3/8" **PRO+** **CV** **POLIGONALE**

BGS articolo	DESCRIZIONE
BGS 9112	SERIE 11 PEZZI, BUSSOLE POLIGONALI IN POLLICI 5/16" - 7/8", ATT. 3/8"

CARATTERISTICHE

- misure: 5/16" - 11/32" - 3/8" - 7/16" - 1/2" - 9/16" - 5/8" - 11/16" - 3/4" - 13/16" - 7/8"
- finitura cromata satinata
- zigrinate
- su guida metallica
- peso: 500 g



1/4"-3/8" **CV** **PRO+** **TORX®**

BGS articolo	DESCRIZIONE
BGS 2038	SERIE 12 PEZZI, BUSSOLE TORX ATT. 1/4" - 3/8"

CARATTERISTICHE

- finitura cromata satinata
- attacco 1/4": E 4-5-6-7-8
- attacco 3/8": E 10-11-12-14-16-18-20
- peso: 370 g

POLLICI



3/8" **PRO+** **CV** **ESAGONO**

BGS articolo	DESCRIZIONE
BGS 9110	SERIE 11 PEZZI, BUSSOLE ESAGONALI IN POLLICI 5/16" - 7/8", ATT. 3/8"

CARATTERISTICHE

- misure: 5/16" - 11/32" - 3/8" - 7/16" - 1/2" - 9/16" - 5/8" - 11/16" - 3/4" - 13/16" - 7/8"
- finitura cromata satinata
- zigrinate
- su guida metallica
- peso: 480 g



1/4" **3/8"** **TORX®** **CV** **PRO+**

BGS articolo	DESCRIZIONE
BGS 9548	SERIE 10 PEZZI, BUSSOLE TORX FEMMINA, E4 - E16, ATT. 1/4" - 3/8"

CARATTERISTICHE

- zigrinate
- su guida metallica
- finitura cromata satinata
- misure:
 - attacco 1/4": E4 - E5 - E6 - E7 - E8
 - attacco 3/8": E10 - E11 - E12 - E14 - E16
- peso: 250 g



1/4" **3/8"** **1/2"** **TORX®** **PRO+**

BGS articolo	DESCRIZIONE
BGS 70099	SET 28 PEZZI, BUSSOLE TORX FEMMINA, E4 - E24, ATT. 1/4" - 3/8" - 1/2"

CARATTERISTICHE

- zigrinato
- finitura cromata satinata
- impronta Torx Femmina
- comprende:
 - attacco 1/4": E4 - E5 - E6 - E7 - E8 - E10 - E11
 - attacco 3/8": E4 - E5 - E6 - E7 - E8 - E10 - E11 - E12 - E14 - E16 - E18 - E20
 - attacco 1/2": E10 - E11 - E12 - E14 - E16 - E18 - E20 - E22 - E24
- peso: 1,3 kg



3/8" **PRO+** **CV** **POLIGONALE**

BGS articolo	DESCRIZIONE
BGS 9105	SERIE 12 PEZZI, BUSSOLE POLIGONALI 8-19 MM, ATT. 3/8"

CARATTERISTICHE

- misure: 8-9-10-11-12-13-14-15-16-17-18-19 mm
- finitura cromata satinata
- zigrinate
- su guida metallica
- peso: 490 g



1/4"-3/8" **CV** **PRO+** **TORX®**

BGS articolo	DESCRIZIONE
BGS 2027	SERIE 7 PEZZI, BUSSOLE TORX, ATT. 1/4" - 3/8"

CARATTERISTICHE

- attacco 1/4": E 6-7-8
- attacco 3/8": E 10-12-14-16
- finitura cromata satinata
- peso: 200 g

TORX®	S mm	S mm	
E 4	3.70	E 16	14.60
E 5	4.60	E 18	16.50
E 6	5.60	E 20	18.30
E 7	6.10	E 22	20.10
E 8	7.40	E 24	22.00
E 10	9.30	E 26	23.70
E 11	9.90	E 28	25.50
E 12	11.00	E 30	27.30
E 14	12.80	E 32	29.00

3/8"



BGS articolo	DESCRIZIONE
BGS 9587	SERIE 7 PEZZI , BUSSOLE TORX PLUS, 10EPL - 20EPL, ATT. 3/8"

CARATTERISTICHE

- misure: 10 EPL - 11 EPL - 12 EPL - 14 EPL - 16 EPL - 18 EPL - 20 EPL
- su guida metallica
- peso: 450 g

TORX PLUS®		S mm	S mm
E 4	3.70	E 16	14.60
E 5	4.60	E 18	16.50
E 6	5.60	E 20	18.30
E 7	6.10	E 22	20.10
E 8	7.40	E 24	22.00
E 10	9.30	E 26	23.70
E 11	9.90	E 28	25.50
E 12	11.00	E 30	27.30
E 14	12.80	E 32	29.00



**BUSSOLE CHROM-VANADIUM - SATINATE
LUNGHE - SURFACE DRIVE
PROFONDITÀ IMPRONTA 28 MM**

Attacco: 3/8"
impronta: SURFACE-DRIVE

BGS articolo	mm	L mm	
BGS 2610	8	63	1
BGS 2611	9	63	1
BGS 2600	10	63	1
BGS 2601	11	63	1
BGS 2602	12	63	1
BGS 2603	13	63	1
BGS 2604	14	63	1
BGS 2605	15	63	1
BGS 2606	16	63	1
BGS 2607	17	63	1
BGS 2608	18	63	1
BGS 2609	19	63	1

BUSSOLE SURFACE DRIVE

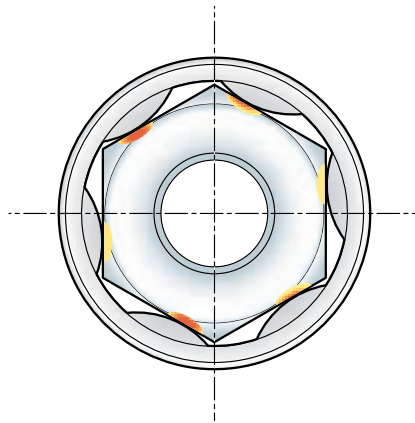

TORX® LUNGHE

Attacco: 3/8"
impronta: TORX®

FERMEC articolo		L mm	
3827-0555	E 5	55	1
3827-0655	E 6	55	1
3827-0755	E 7	55	1
3827-0863	E 8	63	1
3827-1063	E 10	63	1
3827-1163	E 11	63	1
3827-1263	E 12	63	1
3827-1463	E 14	63	1
3827-1663	E 16	63	1
3827-1863	E 18	63	1

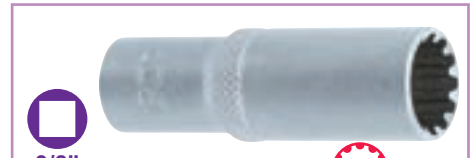

**BUSSOLE CHROM-VANADIUM
MULTIMPRONTA "SPLINE DRIVE" - LUNGHE**

Attacco: 3/8"
impronta: SPLINE DRIVE

BGS articolo	mm	L mm	
BGS 10350	10	63	1
BGS 10351	11	63	1
BGS 10352	12	63	1
BGS 10353	13	63	1
BGS 10354	14	63	1
BGS 10355	15	63	1

MILLIMETRI E POLLICI



PRO+  **CV**

BUSSOLA UNIVERSALE

BGS articolo	PER MISURE	
BGS 2533	3/8" 9-19 MM	1
BGS 2531	1/2" 11-30 MM	1
BGS 2833	3/4" 12-38 MM	1

CARATTERISTICHE

- adatta a tutte le impronte esagonali anche in pollici
- i perni a molla consentono un perfetto adattamento sulla maggior parte dei dadi, viti, viti a gancio, dadi ad alette e gommini

POLLICI



3/8"  **PRO+** **ESAGONO**

BGS articolo	DESCRIZIONE
BGS 9501	SERIE 7 PEZZI, BUSSOLE ESAGONALI IN POLLICI SNODATE 3/8" - 3/4", ATT. 3/8"

CARATTERISTICHE

- misure: 3/8" - 7/16" - 1/2" - 9/16" - 5/8" - 11/16" - 3/4"
- su guida metallica
- peso: 500 g

POLLICI



3/8"  **POLIGONALE**  **PRO+** **CV**

BGS articolo	DESCRIZIONE
BGS 6859	SERIE 11 PEZZI, BUSSOLE POLIGONALI IN POLLICI LUNGHE, 5/16" - 7/8", ATT. 3/8"

CARATTERISTICHE

- finitura satinata cromata
- su guida metallica
- misure: 5/16" - 11/32" - 3/8" - 7/16" - 1/2" - 9/16" - 5/8" - 11/16" - 3/4" - 13/16" - 7/8"
- peso: 1,0 kg

3/8"   **ESAGONO**



PRO+  **CV**

BUSSOLA ESAGONALE SNODATA CROMATA LUCIDATA

BGS articolo	mm	
BGS 2450	10	1
BGS 2452	12	1
BGS 2453	13	1
BGS 2454	14	1
BGS 2455	15	1
BGS 2456	16	1
BGS 2457	17	1
BGS 2458	18	1
BGS 2459	19	1

POLLICI



3/8"  **ESAGONO**  **PRO+** **CV**

BGS articolo	DESCRIZIONE
BGS 2756	SERIE 11 PEZZI, BUSSOLE ESAGONALI IN POLLICI LUNGHE, ATT. 3/8"

CARATTERISTICHE

- esagonali
- 5/16", 11/32", 3/8", 7/16", 1/2", 9/16", 5/8", 11/16", 3/4", 13/16", 7/8"
- finitura satinata cromata
- peso: 1,0 kg

3/8"   **ESAGONO**  **PRO+** **CV**

BGS articolo	DESCRIZIONE
BGS 2222	SERIE 11 PEZZI, BUSSOLE ESAGONALI LUNGHE, 8-19 MM, ATT. 3/8"

CARATTERISTICHE

- finitura cromata satinata
- esagonali
- 8-10-11-12-13-14-15-16-17-18-19 mm
- peso: 1,0 kg



3/8"   **ESAGONO**  **PRO+** **CV**

BGS articolo	DESCRIZIONE
BGS 205	SERIE 10 PEZZI, BUSSOLE ESAGONALI SNODATE, ATT. 3/8"

CARATTERISTICHE

- finitura cromata lucida
- 10-11-12-13-14-15-16-17-18-19 mm
- peso: 710 g





PRO+



POLIGONALE

BGS
articolo

DESCRIZIONE

BGS 5252

**SERIE 11 PEZZI,
 BUSSOLE TIPO LUNGO,
 POLIGONALI, ATT. 3/8"**

CARATTERISTICHE

- misure: 8-10-11-12-13-14-15-16-17-18-19 mm
- finitura satinata cromata
- zigrinate
- su supporto in plastica
- peso: 950 g

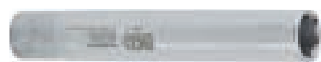

PRO+

BGS
articolo

DESCRIZIONE

BGS 9863

**SET 5 PEZZI,
 BUSSOLE
 ESAGONALI 8-14 MM,
 ATT. 3/8",
 EXTRA LUNGHE**

CARATTERISTICHE

- misure: 8-10-12-13-14 mm
- finitura cromata lucida
- attacco quadro 3/8"
- esagonali
- **lunghezza: 120 mm**
- peso: 870 g

RICAMBI

BGS
articolo

DESCRIZIONE

BGS 9863-8	8 MM
BGS 9863-10	10 MM
BGS 9863-12	12 MM
BGS 9863-13	13 MM
BGS 9863-14	14 MM



PRO+

BGS
articolo

DESCRIZIONE

BGS 70026

**SERIE 10 PEZZI,
 BUSSOLE TORX
 FEMMINA XXL,
 E6 - E20, ATT. 3/8"**

CARATTERISTICHE

- extra lungo, lunghezza: 200 mm
- su guida metallica in alluminio
- impronta: torx femmina
- finitura: satinata cromata
- comprende:
E6, E7, E8, E10, E11, E12, E14, E14, E16, E18, E20
- attacco: quadro femmina 3/8"
- peso: 2,0 kg



PRO+

BGS
articolo

DESCRIZIONE

BGS 1756

**SERIE 10 PEZZI,
 CHIAVI APERTE A
 ZAMPA DI GALLO,
 10-19 MM, ATT. 3/8"**

CARATTERISTICHE

- finitura cromata satinata
- su guida metallica
- misure: 10-11-12-13-14-15-16-17-18-19 mm
- peso: 700 g





PRO+



CHIAVI APERTE A ZAMPA DI GALLO

attacco: 3/8"



BGS articolo	mm	
BGS 1756-10	10	1
BGS 1756-11	11	1
BGS 1756-12	12	1
BGS 1756-13	13	1
BGS 1756-14	14	1
BGS 1756-15	15	1
BGS 1756-16	16	1
BGS 1756-17	17	1
BGS 1756-18	18	1
BGS 1756-19	19	1





3/8" 

PHILLIPS®

attacco: 3/8"
impronta: PHILLIPS®



BGS articolo		L mm	
BGS 2553	PH 1	48	1
BGS 2554	PH 2	48	1
BGS 2556	PH 3	48	1



3/8" 

POZIDRIV®

attacco: 3/8"
impronta: POZIDRIV®

BGS articolo		L mm	
BGS 2550	PZ 1	48	1
BGS 2551	PZ 2	48	1



3/8" 

TAGLIO

attacco: 3/8"
impronta: TAGLIO

BGS articolo		L mm	
BGS 2568	7	48	1



3/8" 

ESAGONO

CHIAVI A BUSSOLA MASCHIO ESAGONALI

Attacco: 3/8"
impronta: ESAGONO

BGS articolo		L mm	
BGS 2576	3	48	1
BGS 2577	4	48	1
BGS 2578	5	48	1
BGS 2579	6	48	1
BGS 2580	7	48	1
BGS 2581	8	48	1
BGS 2583	9	48	1
BGS 2582	10	48	1
BGS 2584	12	48	1

POLLICI





3/8"  **ESAGONO**

MISURE IN POLLICI

Attacco: 3/8"
impronta: ESAGONO



BGS articolo		L mm	
BGS 2720	1/8"	48	1
BGS 2721	5/32"	48	1
BGS 2722	3/16"	48	1
BGS 2723	7/32"	48	1
BGS 2725	1/4"	48	1
BGS 2730	9/32"	48	1
BGS 2727	5/16"	48	1
BGS 2729	3/8"	48	1





3/8"  **ESAGONO**

CHIAVI A BUSSOLA MASCHIO ESAGONALI TESTA SFERICA

Attacco: 3/8"
impronta: ESAGONO



BGS articolo		L mm	
BGS 5110	3	48	1
BGS 5111	4	48	1
BGS 5112	5	48	1
BGS 5113	5,5	48	1
BGS 5114	6	48	1
BGS 5115	8	48	1
3858-0310	3	100	1
3858-0410	4	100	1
3858-0510	5	100	1
3858-0610	6	100	1
3858-0710	7	100	1
3858-0810	8	100	1
3858-1010	10	100	1





3/8" 

CHIAVI A BUSSOLA MASCHIO TORX

Attacco: 3/8"
impronta: TORX®



BGS articolo		L mm	
BGS 2760	TX 10	48	1
BGS 2541	TX 15	48	1
BGS 2542	TX 20	48	1
BGS 2543	TX 25	48	1
BGS 2544	TX 27	48	1
BGS 2545	TX 30	48	1
BGS 2546	TX 40	48	1
BGS 2547	TX 45	48	1
BGS 2548	TX 50	48	1
BGS 2549	TX 55	48	1
BGS 2761	TX 60	48	1
3868-4080	TX 40	80	1
3870-4514	TX 45	140	1



3/8"  **TORX® CON FORO**

CHIAVI A BUSSOLA MASCHIO TORX C/ FORO

Attacco: 3/8"
impronta: TORX® C/FORO

BGS articolo		L mm	
3872-1050	TH 10	50	1
3872-1550	TH 15	50	1
BGS 2571	TH 20	50	1
BGS 2572	TH 25	50	1
BGS 2573	TH 27	50	1
BGS 2574	TH 30	50	1
BGS 2575	TH 40	50	1
BGS 2597	TH 45	50	1
3872-5050	TH 50	50	1
BGS 2599	TH 55	50	1

TORX®	S mm	S mm	
T 6	1.70	T 40	6.70
T 7	2.00	T 45	7.90
T 8	2.30	T 50	8.90
T 9	2.50	T 55	11.30
T 10	2.70	T 60	13.30
T 15	3.30	T 70	15.60
T 20	3.90	T 80	17.60
T 25	4.50	T 90	20.00
T 27	5.00	T 100	22.20
T 30	5.60		

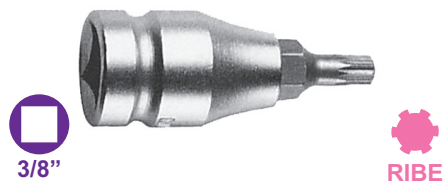

3/8" **RIBE**

CHIAVI A BUSSOLA MASCHIO RIBE

Attacco: 3/8"
impronta: RIBE

FEIMEC articolo	M	L mm	1
3890-0550	M 5	50	1
3890-0650	M 6	50	1
3890-0850	M 8	50	1
3890-1050	M 10	50	1
BGS 4141	M 6	100	1
BGS 4142	M 7	100	1
BGS 4143	M 8	100	1
BGS 4145	M 10	100	1

RIBE	S mm	W mm
M 5	5.00	1.20
M 6	6.00	1.30
M 7	7.00	1.40
M 8	8.00	1.80
M 9	9.00	2.00
M 10	10.00	2.30
M 12	12.00	2.60
M 13	13.00	3.10
M 14	14.00	3.20
M 16	16.00	3.60



3/8" **XZN**

CHIAVI A BUSSOLA MASCHIO XZN

Attacco: 3/8"
impronta: XZN

BGS articolo	M	L mm	1
3880-0550	M 5	50	1
3880-0650	M 6	50	1
BGS 5105-M8	M 8	48	1
3880-1050	M 10	50	1
BGS 2587	M 12	48	1
3882-0890	M 8	90	1
3882-1090	M 10	90	1

XZN	S mm	S mm
M 4	3,60	M12 11,50
M 5	4,80	M14 13,30
M 6	6,10	M16 15,70
M 8	7,30	M18 16,90
M10	9,70	



3/8" **ESAGONO**

CHIAVI A BUSSOLA MASCHIO ESAGONALI

Attacco: 3/8"
impronta: ESAGONO

FEIMEC articolo	mm	L mm
FM 350-100-4	4	100
FM 350-100-5	5	100
FM 350-100-6	6	100
FM 350-100-8	8	100
FM 350-100-10	10	100
FM 350-100-12	12	100



3/8" **TORX**

CHIAVI A BUSSOLA MASCHIO TORX

Attacco: 3/8"
impronta: TORX®

FEIMEC articolo	mm	L mm
FM 351-65-TX10	TX 10	65
FM 351-65-TX15	TX 15	65
FM 351-65-TX20	TX 20	65
FM 351-65-TX25	TX 25	65
FM 351-65-TX27	TX 27	65
FM 351-65-TX30	TX 30	65
FM 351-65-TX40	TX 40	65
FM 351-100-TX10	TX 10	100
FM 351-100-TX15	TX 15	100
FM 351-100-TX20	TX 20	100
FM 351-100-TX25	TX 25	100
FM 351-100-TX27	TX 27	100
FM 351-100-TX30	TX 30	100
FM 351-100-TX40	TX 40	100

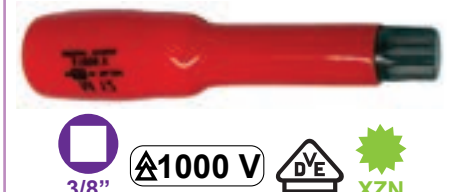

3/8" **XZN**

CHIAVI A BUSSOLA MASCHIO XZN

Attacco: 3/8"
impronta: XZN

FEIMEC articolo	M	L mm
FM 354-100-M8	M 8	100
FM 354-100-M10	M 10	100
FM 354-100-M12	M 12	100

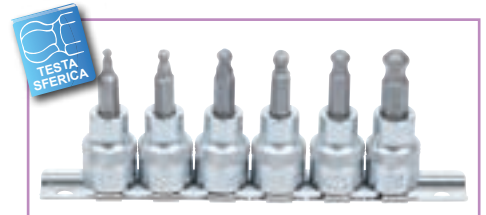

3/8" **PRO+ CV ESAGONO**

BGS articolo	DESCRIZIONE
BGS 5109	SERIE 6 PEZZI, CHIAVI A BUSSOLA ESAGONO MASCHIO CON TESTA SFERICA, 3-8 MM, ATT. 3/8"

- CARATTERISTICHE**
- con testa sferica
 - 3 - 4 - 5 - 5.5 - 6 - 8 mm, lunghezza 50 mm
 - in acciaio al cromo vanadio
 - satinata
 - zigrinate
 - su guida
 - peso: 250 g



3/8" **CV PRO+ ESAGONO**

BGS articolo	DESCRIZIONE
BGS 5107	SERIE 7 PEZZI, CHIAVI A BUSSOLA ESAGONO MASCHIO, ATT. 3/8"

- CARATTERISTICHE**
- misure: 3-4-5-6-7-8-10 mm
 - su guida metallica
 - peso: 340 g

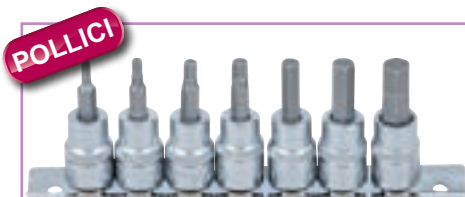

POLLICI



BGS articolo

DESCRIZIONE

BGS 5104

SERIE 7 PEZZI, CHIAVI A BUSSOLA ESAGONO MASCHIO IN POLLICI, ATT. 3/8"

CARATTERISTICHE

- finitura cromata satinata
- misure in pollici: 1/8", 5/32", 3/16", 7/32", 1/4", 5/16", 3/8"
- ideali per auto e moto inglesi ed americane
- su guida metallica
- peso: 310 g

MILLIMETRI E POLLICI **novità**



BGS articolo

DESCRIZIONE

BGS 74258

SET 32 PEZZI, CHIAVI A BUSSOLA ESAGONALI, METRICHE 2-19 MM & IN POLLICI 1/4 - 9/16", ATT. 1/4"-3/8"-1/2"

CARATTERISTICHE

- per uso a mano
- zigrinate
- impronta: esagonale
- attacco: 1/4", 3/8", 1/2"
- materiale: acciaio al cromo vanadio (S2)
- comprende:
 - bussole attacco 1/4", esagonali metriche: 2 mm (BGS 5153), 2,5 mm (BGS 5154), 3 mm (BGS 2497), 4 mm (BGS 2498), 5 mm (BGS 2499), 5,5 mm (BGS 9466), 6 mm (BGS 2500)
 - bussole attacco 1/4", esagonali in pollici: 5/64", 3/32" (BGS 2740), 1/8" (BGS 2741), 5/32" (BGS 2742), 3/16" (BGS 2743), 7/32" (BGS 2744), 1/4" (BGS 2745)
 - bussole attacco 3/8", esagonali metriche: 7 mm (BGS 2580), 8 mm (BGS 2581), 9 mm (BGS 2583), 10 mm (BGS 2582), 12 mm (BGS 2584)
 - bussole attacco 3/8", esagonali in pollici: 9/32" (BGS 2730), 5/16" (BGS 2727), 3/8" (BGS 2729), 7/16", 1/2"
 - bussole attacco 1/2", esagonali metriche: 14 mm (BGS 4257), 15 mm, 17 mm (BGS 5184-H17), 19 mm (BGS 5184-H19)
 - bussole attacco 1/2", esagonali in pollici: 9/16" (BGS 2738), 5/8" (BGS 2751), 11/16" (BGS 2752), 3/4" (BGS 2754)
- peso 2,6 kg



BGS articolo

DESCRIZIONE

BGS 5108

SERIE 7 PEZZI, CHIAVI A BUSSOLA TORX, ATT. 3/8"

CARATTERISTICHE

- Tx: 15- 20-25-30-40-45-50
- finitura cromata satinata
- su guida metallica
- peso: 340 g



1/4"-3/8"-1/2" **ESAGONO**



BGS articolo

DESCRIZIONE

BGS 5099

SERIE 10 PEZZI, CHIAVI A BUSSOLA ESAGONALI EXTRA CORTE, 4 - 19 MM, ATT. 1/4" - 3/8" - 1/2"

CARATTERISTICHE

- attacco 1/4", lunghezza 30 mm: 4 - 5 - 6 - 7 - 8 mm
- attacco 3/8", lunghezza 38 mm: 10 - 12 - 14 mm
- attacco 1/2", lunghezza 48 mm: 17 - 19 mm
- zigrinate
- finitura cromata satinata
- su guida metallica
- peso: 580 g



1/4"-3/8"-1/2" **TORX**



BGS articolo

DESCRIZIONE

BGS 5098

SERIE 12 PEZZI, CHIAVI A BUSSOLA TORX EXTRA CORTE, T8 - T60, ATT. 1/4" - 3/8" - 1/2"

CARATTERISTICHE

- att. 1/4", lungh. 30 mm: T8-T10-T15-T20-T25-T27
- att. 3/8", lungh. 38 mm : T30-T40-T45-T50-T55
- attacco 1/2", lunghezza 48 mm: T60
- zigrinate
- finitura cromata satinata
- su guida metallica
- peso: 400 g

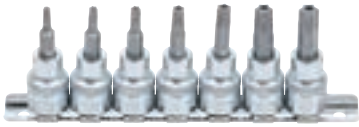

BGS articolo	DESCRIZIONE
BGS 9341	SERIE 7 PEZZI, CHIAVI A BUSSOLA TORX CON FORO, TH15-TH50, ATT. 3/8"

CARATTERISTICHE

- misure: TH15-TH20-TH25-TH30-TH40-TH45-TH50
- lunghezza: 48 mm
- zigriate, finitura satinata cromata
- su guida metallica
- peso: 290 g



BGS articolo	DESCRIZIONE
BGS 5185	SERIE 7 PEZZI, CHIAVI A BUSSOLA RIBE, TIPO LUNGO, ATT. 3/8" - 1/2"

CARATTERISTICHE

- attacco 3/8": M6, M7, M8, M10
- attacco 1/2": M12, M13, M14
- **profilo a cuneo**
- in acciaio al cromo vanadio
- satinare, zigriate
- lunghezza: 75 mm
- su guida
- peso: 640 g



BGS articolo	DESCRIZIONE
BGS 9756	SERIE 5 PEZZI, CHIAVI A BUSSOLA MORTORQ, MTS0-MTS4, ATT. 3/8"

CARATTERISTICHE

- attacco quadro femmina 3/8"
- finitura: satinata cromata
- su guida metallica
- chiavi a bussola per MTS-Mortorq, misure: #0, #1, #2, #3, #4
- peso: 290 g



BGS articolo	DESCRIZIONE
BGS 5105	SERIE 8 PEZZI, CHIAVI A BUSSOLA XZN, ATT. 1/4" - 3/8" - 1/2"

CARATTERISTICHE

- comprende:
 - attacco 1/4": M4-M5-M6
 - attacco 3/8": M8-10-12
 - attacco 1/2": M-14-16
- finitura cromata satinata
- su guida metallica
- peso: 470 g



FERMEC articolo	DESCRIZIONE
TM-200601	SERIE 6 PEZZI, CHIAVI A BUSSOLA MORTORQ, ATT. 3/8"

CARATTERISTICHE

- misure: MTS 00 - MTS 0 - MTS 1 - MTS 2 - MTS 3 - MTS 4
- lunghezza: 50 mm
- finitura cromata satinata
- in chrome vanadium
- su guida metallica
- per Jeep e FCA





ADATTATORI DOPPIO QUADRO MASCHIO

articolo		L mm
2841	1/4"	20
3841	3/8"	30
4841	1/2"	37
BGS 9623	3/4"	53
8841	1"	68



CARATTERISTICHE

- con doppia sfera

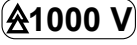

3/8"  **3/8"**

PROLUNGHE

1000 V  

FEWMEC articolo	L mm	
FM 285-3/8-125	125	
FM 285-3/8-250	250	

CARATTERISTICHE

- IEC 60900
- 1000 V





3/8"  **3/8"**

TESTA SFERICA 

PROLUNGHE TESTA SFERICA

BGS articolo	L mm	
BGS 242	75	1
BGS 246	125	1
BGS 243	150	1
BGS 244	250	1
BGS 247	450	1



3/8"  **3/8"**

PROLUNGHE

attacco: 3/8"

BGS articolo	L mm	
BGS 296	50	1
BGS 294	75	1
BGS 295	150	1
BGS 3133	375	1
BGS 3136	450	1
BGS 3137	600	1
BGS 3132	610	1





3/8"  **3/8"**

TESTA SFERICA  

BGS articolo	DESCRIZIONE
BGS 6111	SET 5 PEZZI, PROLUNGHE TESTA SFERICA, ATT. 3/8"

CARATTERISTICHE

- comprende le seguenti misure:
 - att. 3/8", lunghezza: 38, 75, 150, 250, 450 mm
- finitura cromata lucida
- in supporto in plastica
- peso: 920 g



3/8"  **3/8"**

 

BGS articolo	DESCRIZIONE
BGS 92236	SET 3 PEZZI PROLUNGHE

CARATTERISTICHE

- lunghezze: 375-450-600 mm
- acciaio al carbonio
- lucide
- peso: 1,3 kg







1/4"-3/8"-1/2"   

BGS articolo	DESCRIZIONE
BGS 6113	SET 9 PEZZI, PROLUNGHE TESTA SFERICA, ATT. 1/4" - 3/8" - 1/2"

CARATTERISTICHE

- comprende le seguenti misure:
 - att. 1/4", lunghezza: 50, 100, 225 mm;
 - att. 3/8", lunghezza: 75, 150, 225 mm;
 - att. 1/2", lunghezza: 50, 125, 250 mm.
- finitura cromata lucida
- in supporto in plastica
- peso: 1,3 kg



1/4"-3/8"-1/2" PRO+

BGS articolo	DESCRIZIONE
BGS 2253	SET 9 PEZZI, PROLUNGHE TESTA SFERICA, ATT. 1/4" - 3/8" - 1/2"

- CARATTERISTICHE**
- comprende le seguenti misure:
 - att. 1/4", lunghezza: 50 mm, 100 mm, 250 mm;
 - att. 3/8", lunghezza: 75 mm, 150 mm, 250 mm;
 - att. 1/2", lunghezza: 50 mm, 125 mm, 250 mm.
 - peso: 18 kg

RICAMBI			
BGS articolo	1/4"	L mm	
BGS 2232	1/4"	50	
BGS 2231	1/4"	100	
BGS 2219	1/4"	250	
BGS 242	3/8"	75	
BGS 243	3/8"	150	
BGS 244	3/8"	250	
BGS 233	1/2"	50	
BGS 234	1/2"	125	
BGS 235	1/2"	250	



3/8" PRO+ CV 3/8"

BGS articolo	DESCRIZIONE
BGS 2239	SET 3 PEZZI, PROLUNGHE, ATT. 3/8"

- CARATTERISTICHE**
- lunghezze: 75-150-250 mm
 - testa sferica
 - finitura cromata satinata
 - zigrinate
 - peso: 470 g



FEMMINA MASCHIO

PROLUNGA FLESSIBILE MASCHIO - FEMMINA PER BUSSOLE

Koken articolo	MASCHIO	FEMMINA	L mm	
3762	3/8"	3/8"	300	1



1/4"-3/8"-1/2" 1/4"-3/8"-1/2"

PRO+ CV

BGS articolo	DESCRIZIONE
BGS 198	SET 3 PEZZI, PROLUNGHE MAGNETICHE

- CARATTERISTICHE**
- per trattenerne viti e bulloni nella bussola
 - peso: 400 g



3/8" SNODO attacco: 3/8"

BGS articolo	L mm	
BGS 299	55	1



1/4"-3/8"-1/2" 1/4"-3/8"-1/2"

PRO+ CV

BGS articolo	DESCRIZIONE
BGS 252	SET 3 PEZZI, SNODO CON MOLLA

- CARATTERISTICHE**
- cromati
 - peso: 280 g



F SFERA M

PRO+ CV 1000 V DVE

FERMEC articolo	FEMMINA	MASCHIO
FM 312-3/8-1/2	3/8"	1/2"
FM 312-1/2-3/8	1/2"	3/8"

- CARATTERISTICHE**
- conformi DIN EN 60900
 - isolati VDE fino a 1000 V



1/4"-3/8"-1/2"-3/4" 1/4"-3/8"-1/2"-3/4"

**RACCORDI DI RIDUZIONE
CHROM-VANADIUM**

attacco: 1/4" - 3/8" - 1/2" - 3/4"

BGS articolo	FEMMINA	MASCHIO	
BGS 271	1/4"	3/8"	1
BGS 269	3/8"	1/4"	1
BGS 280	3/8"	1/2"	1
BGS 270	1/2"	3/8"	1
BGS 272	1/2"	3/4"	1
BGS 274	3/4"	1/2"	1



BGS articolo	DESCRIZIONE
BGS 199	SET 6 PEZZI, ADATTATORI

CARATTERISTICHE

- cromati satinati

CONTENUTO

- 1/4" F X 3/8" M, coppia massima 60 Nm
- 3/8" F X 1/4" M, coppia massima 60 Nm
- 3/8" F X 1/2" M, coppia massima 200 Nm
- 1/2" F X 3/8" M, coppia massima 200 Nm
- 1/2" F X 3/4" M, coppia massima 500 Nm
- 3/4" F X 1/2" M, coppia massima 500 Nm
- peso: 620 g

RICAMBI









BGS articolo	DESCRIZIONE
BGS 199-LEER	CASSETTA VUOTA



1/4"-3/8"-1/2"

BGS articolo	DESCRIZIONE
BGS 8808	SET 4 PEZZI, RIDUZIONI

CARATTERISTICHE

- comprende 4 riduzioni:
 -  1/4" F -  3/8" M
 -  3/8" F -  1/4" M
 -  3/8" F -  1/2" M
 -  1/2" F -  3/8" M
- finitura cromata satinata
- peso: 140 g

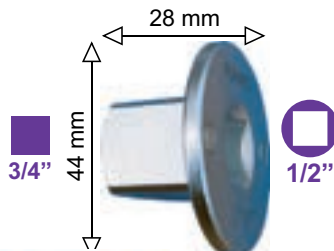
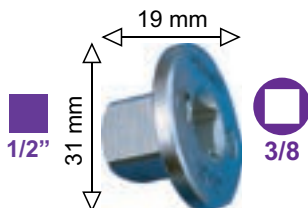
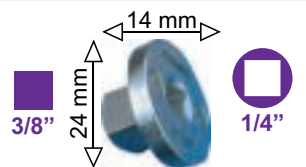

**RACCORDI DI RIDUZIONE MAGNETICI
A SCOMPARSA IDEALI PER CHIAVI
DINAMOMETRICHE E SPAZI RIDOTTI**

attacco: 1/4"-3/8"-1/2"

FEIMEC articolo	FEMMINA	MASCHIO	
1434-1/4	1/4"	3/8"	1
1434-3/8	3/8"	1/2"	1
1434-1/2	1/2"	3/4"	1



SFERA



**RIDUZIONI A SCOMPARSA
CON SFERA NEL QUADRO MASCHIO**

Kokon articolo	F	M	D mm	L mm	
2756 Z-3/8	1/4"	3/8"	20.3	21.5	1
2756 Z-1/2	1/4"	1/2"	20.3	26	1
3756 Z-1/2	3/8"	1/2"	28	29	1



**RACCORDI DI RIDUZIONE MAGNETICI
"POWER IMPACT"
A SCOMPARSA - SPAZI RIDOTTI**

FEIMEC articolo	F	M	L mm	
698-00	1/4"	3/8"	17	1
698-0	1/4"	1/2"	22	1
698-1	3/8"	1/2"	22	1
698-11	1/2"	3/4"	30	1
698-8	3/4"	1"	35	1
698-13	1"	1 1/2"	50	1
698-15	1 1/2"	2 1/2"	60	1

698	CASSETTA 4 PZ. CONTENUTO: 1 PZ. 698-00 1 PZ. 698-1 1 PZ. 698-11 1 PZ. 698-8			1
-----	--	--	--	---

3/8"

BGS
articolo

DESCRIZIONE

BGS 288

**ADATTATORE
SCORREVOLE PER
BARRE ATT. 3/8"**

CARATTERISTICHE

- cromata, satinata
- per impiego con prolunghe
- peso: 70 g

**ASTA CON QUADRO MASCHIO 3/8"
SCORREVOLE**
BGS
articoloL
mm

BGS 277

200

1

CARATTERISTICHE

- cromata, satinata
- peso: 180 g



BGS 9880-REP

BGS
articolo

DESCRIZIONE

BGS 9880

**IMPUGNATURA
SNODATA 3/8",
450 MM**

CARATTERISTICHE

- lunghezza: 450 mm
- coppia massima: 740 Nm
- peso: 750 g

RICAMBI

BGS
articolo

DESCRIZIONE

BGS 9880-REP

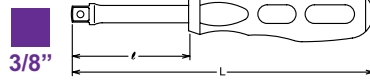
SET RIPARAZIONE

IMPUGNATURE PORTA BUSSOLE

Koken

articolo

3769 N-160

3/8"

L
mm

160



1

3769 N-230

3/8"

230

1

**IMPUGNATURE A TESTA SFERICA PORTA
BUSSOLE**
SISTEMA WOBBLE-FIX CON

Wobble

DUE MODALITÀ DI UTILIZZO:

- PROLUNGA TESTA SFERICA ANGOLO 15°
- PROLUNGA TRADIZIONALE

Fix

15°

15°

attacco: 3/8"

Koken

articolo

3769 NWF-160

3/8"

L
mm

160



1

3769 NWF-230

3/8"

230

1

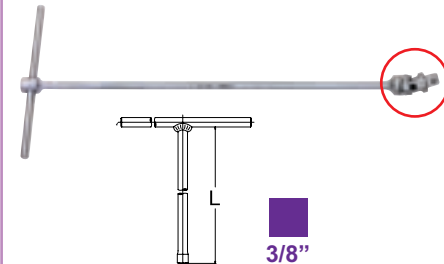
**CHIAVE A "T" QUADRO MASCHIO SNODATA
CROMATA ASTA SCORREVOLE
CHROM-VANADIUM**

FERMEC

articolo

581-3/8

3/8"

L
mm

500

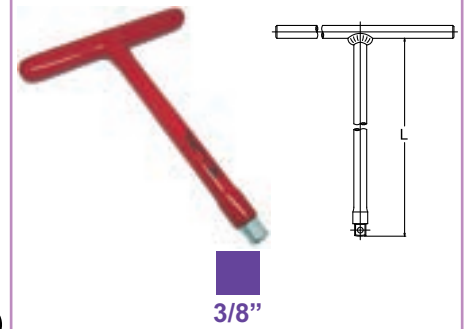

1

1000 V

CHIAVI A "T"

FERMEC

articolo

FM 290-3/8

M

L
mm

3/8"

200

CARATTERISTICHE

- IEC 60900
- 1000 V

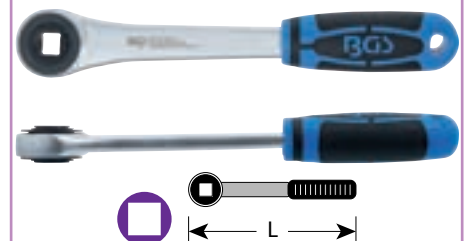
**CRICCHETTO REVERSIBILE CON QUADRO
FEMMINA PASSANTE**

FERMEC

articolo

BGS 9160

L
mm

1/4"

115

BGS 312

1/2"

270

BGS 9622

3/4"

500

CARATTERISTICHE

- quadro passante
- impugnatura rivestita



BGS articolo **3/8" PRO+**

DESCRIZIONE
CRICCHETTO REVERSIBILE, ATT. 3/8", LUNGH. 200 MM

- CARATTERISTICHE**
- modello dritto
 - cricchetto reversibile 72 denti
 - con pulsante di sgancio rapido
 - impugnatura in materiale bi-componente
 - finitura: cromato satinato
 - lunghezza: 200 mm
 - peso: 330 g



3/8"

NUOVO CRICCHETTO REVERSIBILI A 72 DENTI CON PULSANTE DI SBLOCCAGGIO DELLA BUSSOLA ED IMPUGNATURA ERGONOMICA BICOMPONENTE ANTISCIVOLO E FORMA OVALE

articolo	L mm	1
672	3/8"	190



3/8" CV  **MECCANISMO 72 DENTI**

DESCRIZIONE
CRICCHETTO REVERSIBILE, ATT. 3/8", LUNGH. 215 MM, 72 DENTI

- CARATTERISTICHE**
- impugnatura in materiale bi-componente
 - con sgancio rapido
 - lunghezza 215 mm
 - peso: 310 g



novità

CV **3/8" PRO+**

DESCRIZIONE
CRICCHETTO REVERSIBILE, ATT. 3/8", LUNGH. 205 MM, 90 DENTI

- CARATTERISTICHE**
- cricchetto reversibile 90 denti
 - con pulsante di sgancio rapido
 - impugnatura in materiale bi-componente
 - finitura: cromata satinata
 - lunghezza: 205 mm
 - peso: 310 g



novità

CV **3/8" PRO+**

DESCRIZIONE
CRICCHETTO REVERSIBILE, ATT. 3/8", LUNGH. 205 MM, 90 DENTI

- CARATTERISTICHE**
- cricchetto reversibile 90 denti
 - con pulsante di sgancio rapido
 - impugnatura in materiale bi-componente
 - finitura: cromata satinata
 - lunghezza: 255 mm
 - peso: 310 g



MECCANISMO 72 DENTI

3/8" PRO+

DESCRIZIONE
CRICCHETTO REVERSIBILE, ATT. 3/8", LUNGH. 254 MM, 72 DENTI

- CARATTERISTICHE**
- 72 denti
 - lunghezza: 254 mm
 - impugnatura ergonomica antiscivolo in materiale bi-componente
 - peso: 360 g



BGS 303-1

MECCANISMO 72 DENTI

3/8" PRO+

DESCRIZIONE
CRICCHETTO IN NYLON E FIBRA DI VETRO, ATT. 3/8", LUNGH. 205 MM, 72 DENTI

- CARATTERISTICHE**
- comodo utilizzo grazie ai materiali ultra-leggeri, nessun affaticamento
 - i test su questo attrezzo hanno ottenuto risultati per capacità massima decisamente superiori ai limiti DIN
 - lunghezza: circa 205 mm
 - in polipropilene rivestito in acciaio CR-V con impugnatura in materiale bi-componente
 - peso 230 g

RICAMBI

articolo	DESCRIZIONE
BGS 303-1	SET RIPARAZIONE CRICCHETTO



3/8" PRO+

DESCRIZIONE
CRICCHETTO REVERSIBILE, ATT. 3/8", LUNGH. 135 MM, EXTRA CORTO

- CARATTERISTICHE**
- modello extra corto
 - con pulsante di sgancio rapido
 - impugnatura in materiale bi-componente
 - finitura: cromato satinato
 - lunghezza: 135 mm
 - peso: 250 g

3/8"

**novità**

3/8"

PRO+

BGS
articolo

DESCRIZIONE

BGS 643

**MINI-CRICCHETTO
REVERSIBILE,
ATT. 3/8",
LUNGH. 135 MM,
EXTRA CORTO**

CARATTERISTICHE

- design compatto
- reversibile
- con pulsante di sgancio rapido
- attacco quadro maschio: 3/8"
- numero di denti testa del cricchetto: 90
- impugnatura in materiale bi-componente
- materiale: acciaio al cromo vanadio
- finitura: cromata satinata
- lunghezza: 135 mm
- peso: 310 g



3/8"

CV

PRO+

BGS
articolo

DESCRIZIONE

BGS 611

**CRICCHETTO
REVERSIBILE,
ATT. 3/8",
LUNGH. 195 MM,
"EXTRA SLIM"**

CARATTERISTICHE

- cricchetto reversibile 72 denti
- modello dritto "extra slim"
- con pulsante di sgancio rapido
- acciaio al Cromo Vanadio
- lunghezza: 195 mm
- impugnatura in materiale bi-componente
- peso: 220 g

TESTA SNODATA
+
ESTENSIBILEMECCANISMO
72
DENTI

BGS 177



3/8"

PRO+

CV

BGS
articolo

DESCRIZIONE

BGS 25106

**CRICCHETTO
REVERSIBILE
ESTENSIBILE SNODATO,
ATT. 3/8", 240-340 MM,
72 DENTI**

CARATTERISTICHE

- regolabile in 4 posizioni da 240 a 340 mm
- testa snodata regolabile in 10 posizioni
- cricchetto 72 denti
- con pulsante di sgancio rapido
- acciaio al cromo vanadio, satinato
- peso: 630 g

RICAMBI

BGS
articolo

DESCRIZIONE

BGS 177

**SET RIPARAZIONE
CRICCHETTO**

QUANDO MANCA
LO SPAZIO**novità**

3/8"

PRO+

CV

BGS
articolo

DESCRIZIONE

BGS 106

**CRICCHETTO
REVERSIBILE, AD
IMPUGNATURA
ROTATIVA,
ATT. 3/8",
LUNGH. 245 MM**

CARATTERISTICHE

- dentatura fine
- reversibile
- doppia funzione:
 - ruotando l'impugnatura si ottiene un movimento rotatorio del quadro
 - azione a "cricchetto tradizionale"
- attacco quadro maschio: 3/8"
- impugnatura ergonomica
- materiale: acciaio al cromo vanadio
- finitura: cromata satinata
- lunghezza: 245 mm
- larghezza: 38 mm
- peso: 430 g



3/8"

PRO+

MECCANISMO
72
DENTIBGS
articolo

DESCRIZIONE

BGS 113

**CRICCHETTO
REVERSIBILE,
ATT. 3/8",
LUNGH. 230 MM,
72 DENTI,
TESTA SNODATA**

CARATTERISTICHE

- testa snodata 180°
- finitura cromata
- cricchetto reversibile 72 denti
- con pulsante di sgancio rapido
- lunghezza 230 mm
- peso: 380 g

MECCANISMO
45
DENTI

3/8"

PRO+

CV

BGS
articolo

DESCRIZIONE

BGS 286

**CRICCHETTO
REVERSIBILE,
ATT. 3/8",
LUNGH. 270 MM,
45 DENTI, TESTA
SNODATA REGOLABILE**

CARATTERISTICHE

- finitura satinata cromata
- testa snodata regolabile in 5 posizioni
- 45 denti
- con pulsante di sgancio rapido
- impugnatura con occhio
- lunghezza 270 mm
- peso: 410 g



novità

M

PRO+ CV Δ 1000 V 

CRICCHETTO REVERSIBILE, ISOLATI VDE, 1000 V

BGS articolo	Nr. denti	L mm
BGS 701	3/8" 72	200

CARATTERISTICHE

- conformi DIN EN 60900
- isolati VDE fino a 1000 V
- con pulsante di sgancio rapido
- peso: 400 g



novità

3 IN 1

1/4" 3/8" 1/2" 

BGS articolo

DESCRIZIONE

BGS 71015 CRICCHETTO REVERSIBILE, DENTE FINE, 3 IN 1, 1/4" / 3/8" / 1/2"

CARATTERISTICHE

- in acciaio
- per bussole con attacco quadro 1/4", 3/8", 1/2"
- 72 denti
- tutti gli attacchi integrati in un unico profilo quadrato di uscita
- con leva di inversione
- materiale: acciaio al carbonio
- finitura: lucidatura a specchio
- lunghezza: 190 mm
- peso: 360 g



novità

3/8" Δ 1000 V  PRO+

BGS articolo

DESCRIZIONE

BGS 625 CRICCHETTO REVERSIBILE ISOLATO VDE, ATT. 3/8", 1000 V

CARATTERISTICHE

- ideale per l'utilizzo su impianti elettrici o per i lavori di riparazione e manutenzione di veicoli ibridi ed elettrici
- riduce il rischio di cortocircuiti
- ideale per elettricisti e specialisti del settore elettrico
- con pulsante di sgancio rapido
- reversibile
- conforme DIN EN/IEC 60900
- isolato VDE fino a 1000 V
- attacco quadro: 3/8"
- numero di denti: 36
- Standard DIN: EN 60900
- lunghezza: 200 mm
- materiale: acciaio al cromo vanadio
- finitura superficiale: Isolamento VDE
- impugnatura in materiale bi-componente
- peso: 400 g



novità

ESTENSIBILI & SNODATI

1/4" 3/8" 1/2" PRO+

CRICCHETTI REVERSIBILI ESTENSIBILI, SNODATI

BGS articolo	DESC	DESCRIZIONE
BGS 25125	1/4"	210 - 250 MM
BGS 25126	3/8"	260 - 365 MM
BGS 25127	1/2"	350 - 490 MM

CARATTERISTICHE

- leva lunga estensibile e snodata
- bloccabile in varie posizioni mediante un anello autobloccante
- con pulsante di sgancio rapido
- impugnatura in materiale bi-componente antiscivolo ed ergonomica
- cricchetti reversibili 72 denti, snodati 180°
- attacco quadro
- materiale: acciaio al cromo vanadio
- finitura: cromata satinata



novità

ESTENSIBILI

1/4" 3/8" 1/2" CV PRO+

CRICCHETTI REVERSIBILI ESTENSIBILI

BGS articolo	DESC	DESCRIZIONE
BGS 25120	1/4"	190 - 225 MM
BGS 25121	3/8"	240 - 345 MM
BGS 25122	1/2"	305 - 445 MM

CARATTERISTICHE

- leva lunga estensibile e snodata
- bloccabile in varie posizioni mediante un anello autobloccante
- con pulsante di sgancio rapido
- impugnatura in materiale bi-componente antiscivolo ed ergonomica
- cricchetti reversibili 72 denti
- attacco quadro
- materiale: acciaio al cromo vanadio
- finitura: cromata satinata

3/8"



novità

EXTRA-LUNGHE



BGS 635-REPAIR BGS 636-REPAIR BGS 637-REPAIR

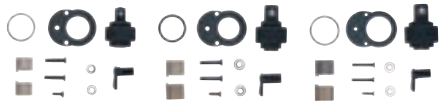

CRICCHETTI REVERSIBILI, EXTRA LUNGHI

BGS articolo	LUNGHEZZA mm
BGS 635	300
BGS 636	455
BGS 637	605

CARATTERISTICHE

- sforzo ridotto grazie alla leva più lunga
- dritte
- 72 denti
- con pulsante di sgancio rapido
- con cricchetto reversibile
- attacco quadro maschio
- impugnatura in materiale bi-componente
- materiale: acciaio al cromo vanadio
- finitura: cromato satinato

RICAMBI

BGS articolo	DESCRIZIONE
BGS 635-REPAIR	PER BGS 635 & BGS 638
BGS 636-REPAIR	PER BGS 636 & BGS 639
BGS 637-REPAIR	PER BGS 637 & BGS 640



novità

SNODATE



BGS 635-REPAIR BGS 636-REPAIR BGS 637-REPAIR



CRICCHETTI REVERSIBILI, EXTRA LUNGHI

BGS articolo	LUNGHEZZA mm
BGS 638	304
BGS 639	457
BGS 640	609

CARATTERISTICHE

- testa a cricchetto snodata 180°
- sforzo ridotto grazie alla leva più lunga
- dritte
- 72 denti
- con pulsante di sgancio rapido
- con cricchetto reversibile
- attacco quadro maschio
- impugnatura in materiale bi-componente
- materiale: acciaio al cromo vanadio
- finitura: cromato satinato

RICAMBI

BGS articolo	DESCRIZIONE
BGS 635-REPAIR	PER BGS 635 & BGS 638
BGS 636-REPAIR	PER BGS 636 & BGS 639
BGS 637-REPAIR	PER BGS 637 & BGS 640



novità

ESTENSIBILI & SNODATI



BGS articolo	DESCRIZIONE
BGS 25128	SET 3 PEZZI, CRICCHETTI REVERSIBILI ESTENSIBILI, SNODATI, ATTACCO 1/4" - 3/8" - 1/2"

CARATTERISTICHE

- leva lunga estensibile e snodata
- bloccabile in varie posizioni mediante un anello autobloccante
- con pulsante di sgancio rapido
- impugnatura in materiale bi-componente antiscivolo ed ergonomica
- cricchetti reversibili 72 denti, snodati 180°
- attacco quadro
- materiale: acciaio al cromo vanadio
- finitura: cromata satinata
- comprende:
 - 1 cricchetto reversibile, estensibile, snodato, attacco 1/4", 210 - 250 mm (BGS 25125)
 - 1 cricchetto reversibile, estensibile, snodato, attacco 3/8", 260 - 365 mm (BGS 25126)
 - 1 cricchetto reversibile, estensibile, snodato, attacco 1/2", 350 - 490 mm (BGS 25127)
- peso 2,7 kg



novità

ESTENSIBILI

1/4" 3/8" 1/2" **CV** PRO+

BGS articolo	DESCRIZIONE
BGS 25123	SET 3 PEZZI, CRICCHETTI REVERSIBILI ESTENSIBILI, ATTACCO 1/4" - 3/8" - 1/2"

CARATTERISTICHE

- leva lunga estensibile e snodata
- bloccabile in varie posizioni mediante un anello autobloccante
- con pulsante di sgancio rapido
- impugnatura in materiale bi-componente antiscivolo ed ergonomica
- cricchetti reversibili 72 denti
- attacco quadro
- materiale: acciaio al cromo vanadio
- finitura: cromata satinata
- comprende:
 - 1 cricchetto reversibile, estensibile, attacco 1/4", 190 - 225 mm (BGS 25120)
 - 1 cricchetto reversibile, estensibile, attacco 3/8", 240 - 345 mm (BGS 25121)
 - 1 cricchetto reversibile, estensibile, attacco 1/2", 305 - 445 mm (BGS 25122)
- peso 2,5 kg



novità

ESTENSIBILI

1/4" 3/8" 1/2"

BGS articolo	DESCRIZIONE
BGS 72113	SET 3 PEZZI, CRICCHETTI REVERSIBILI ESTENSIBILI, ATTACCO 1/4" - 3/8" - 1/2"

CARATTERISTICHE

- braccio di leva lungo e telescopico per applicare facilmente coppie elevate
- bloccabile in varie fasi mediante anello autoserrante
- con sgancio rapido
- impugnatura in materiale bi-componente antiscivolo ed ergonomica
- 72 denti
- cricchetti reversibili con leva di inversione
- quadro con sfera di bloccaggio
- materiale: acciaio al cromo vanadio
- finitura: cromata satinata
- comprende:
 - 1 cricchetto reversibile estensibile, attacco 1/4", regolabile in 4 lunghezze, lunghezza massima 200 mm
 - 1 cricchetto reversibile estensibile, attacco 3/8", regolabile in 5 lunghezze, lunghezza massima 320 mm
 - 1 cricchetto reversibile estensibile, attacco 1/2", regolabile in 6 lunghezze, lunghezza massima 445 mm
- peso: 2,7 kg



novità

KIT DI RIPARAZIONE PER TESTA A CRICCHETTO

BGS articolo	
BGS 72115	1/4"
BGS 72116	3/8"
BGS 72117	1/2"

CARATTERISTICHE

- tutte le parti di usura per la testa del cricchetto in un unico set
- per BGS 72113 e BGS 72114



MECCANISMO 72 DENTI

1/4"-3/8"-1/2"

PRO+ **CV**

BGS articolo	DESCRIZIONE
BGS 215	SET 3 PEZZI, CRICCHETTI REVERSIBILI COMPATTI 1/4"-3/8"-1/2"

CARATTERISTICHE

- formato extra-small per spazi ridotti e angusti
- 72 denti
- lunghezza cricchetti:
 - attacco 1/4": 110 mm
 - attacco 3/8": 140 mm
 - attacco 1/2": 170 mm
- peso: 1,2 kg

SET 3/8"



1/4"-3/8"-1/2" **CV** **PRO+**

BGS articolo	DESCRIZIONE
BGS 621	SET 3 PEZZI, CRICCHETTI REVERIBILI, 1/4"-3/8"-1/2"

CARATTERISTICHE

- impugnatura ergonomica antiscivolo in materiale bi-componente
- stelo sfasato
- con pulsante di sgancio rapido
- cricchetto reversibile 72 denti
- lunghezza:
 - cricchetto reversibile attacco 1/4" (BGS 618): 150 mm
 - cricchetto reversibile attacco 3/8" (BGS 619): 200 mm
 - cricchetto reversibile attacco 1/2" (BGS 620): 250 mm
- peso: 1,4 kg

RICAMBI

BGS articolo	DESCRIZIONE
BGS 618	CRICCHETTO REVERIBILE, ATTACCO 1/4"
BGS 618-1	SET RIPARAZIONE CRICCHETTO, ATTACCO 1/4"
BGS 619	CRICCHETTO REVERIBILE, ATTACCO 3/8"
BGS 619-1	SET RIPARAZIONE CRICCHETTO, ATTACCO 3/8"
BGS 620	CRICCHETTO REVERIBILE, ATTACCO 1/2"
BGS 620-1	SET RIPARAZIONE CRICCHETTO, ATTACCO 1/2"



MECCANISMO 45 DENTI

BGS articolo	DESCRIZIONE
BGS 15112	SET 7 PEZZI, BUSSOLE ATT. 3/8"

CARATTERISTICHE

- chiave a cricchetto, reversibile con pulsante di sgancio rapido
- bussole da 8 - 10 - 13 - 15 - 17 e 19 mm
- peso: 620 g



BUSSOLE ESAGONALI

BGS articolo	DESCRIZIONE
BGS 9366	SET 44 PEZZI, BUSSOLE PASSANTI

CARATTERISTICHE

- ideale per avvitare dadi con fuoriuscita del filetto
- materiale:
 - bussole in acciaio Chrome-Vanadium
 - inserti in acciaio Chrome-Vanadium S2
- comprende:
 - cricchetto passante, 72 denti, misura interna 12 mm
 - bussole esagonali passanti, attacco speciale 12 mm: 6-7-8-9-10-11-12-13-14 mm
 - adattatore attacco speciale 12 mm-quadro maschio 3/8"
 - 33 inserti in acciaio S2, attacco speciale 12 mm
 - XZN: M4 - M5 - M6 - M8 - M10 - M12
 - RIBE: M5 - M6 - M7 - M8 - M10 - M12 - M13
 - Torx: TX15-TX20-TX25-TX27-TX30-TX40-TX45
 - Torx c/Foro: TH15-TH20-TH25-TH27-TH30-TH40-TH45
 - Esagonali: 4 - 5 - 6 - 7 - 8 - 10 mm
- peso: 1,2 kg



SURFACE DRIVE

BGS articolo	DESCRIZIONE
BGS 2227	SET 26 PEZZI, BUSSOLE ATT. 3/8"

CARATTERISTICHE

- durezza e coppia in conformità con le norme DIN
- bussole "surface drive"
- 18 bussole: 6-7-8-9-10-11-12-13-14-15-16-17-18-19-20-21-22-24 mm
- bussole zigrinate, finitura satinata cromata
- 3 barre di prolunga 45-75-150 mm c/esagono
- 2 bussole per candele 16+21 mm
- 1 snodo
- chiave a cricchetto reversibile con pulsante di sgancio rapido
- adattatore 3/8" M - 1/2" F
- peso: 2,3 kg

RICAMBI

BGS articolo	DESCRIZIONE
BGS 2227-LEER	CASSETTA VUOTA

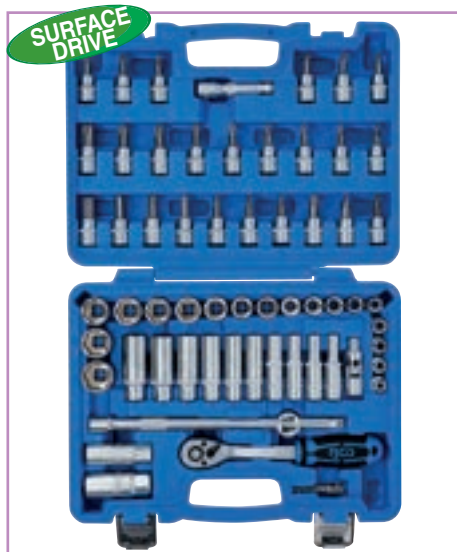

SURFACE DRIVE



3/8"



PRO+

BGS articolo

DESCRIZIONE

BGS 2229

**SET 61 PEZZI,
BUSSOLE ATT. 3/8"**

CARATTERISTICHE

- durezza e coppia in conformità con DIN
- chiavi a bussola: TX15-20-25-27-30-40-45-50-55
- PH 1-3
- PZ 1-3
- Taglio 5,5 - 7-8 mm
- Esagono 3-7, 8, 10 mm
- 18 bussole "Surface drive", 6-24 mm
- 10 bussole lunghe "Surface drive" 8-19 mm
- 2 bussole per candele 21 e 16 mm
- 1 snodo da 3/8" con molla
- 1 barra scorrevole a T/barra su prolunga 250 mm
- 1 barra di prolunga c/testa sferica 75 mm
- 1 chiave a cricchetto reversibile a 72 denti
- 1 adattatore da attacco quadro 3/8" x 5/16" mm esagonale
- peso: 4,2 kg

RICAMBI

BGS articolo

DESCRIZIONE

BGS 2229-1

**ADATTATORE
ESAG. 5/16
QUADRO 3/8"**

BGS 2229-LEER

CASSETTA VUOTA

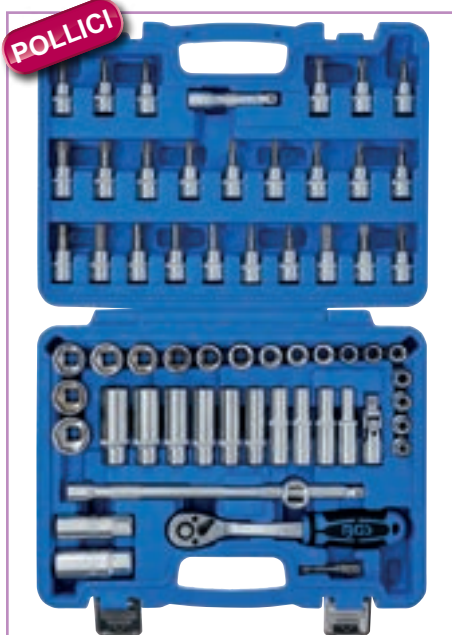

POLLICI



3/8"



PRO+

BGS articolo

DESCRIZIONE

BGS 2215

**SET 61 PEZZI,
BUSSOLE IN POLLICI,
ATT. 3/8 "**

CARATTERISTICHE

- durezza e coppia in conformità con DIN
- chiavi a bussola: TX15-20-25-27-30-40-45-50-55
- PH 1-3,
- PZ 1-3
- inserti Taglio 7/32"-15/16"
- inserti esagonali 1/8"-3/8"
- 18 bussole esagonali 1/4"-15/16"
- 10 bussole lunghe esagonali 5/16"-3/4"
- 2 bussole per candele 5/8" + 13/16"
- 1 snodo da 3/8" con molla
- 1 barra scorrevole a T/barra di prolunga 250 mm
- 1 barra di prolunga c/testa sferica 75 mm
- 1 chiave a cricchetto reversibile a 72 denti
- 1 adattatore da attacco quadro 3/8" x 8 mm esagonale
- peso: 4,2 kg

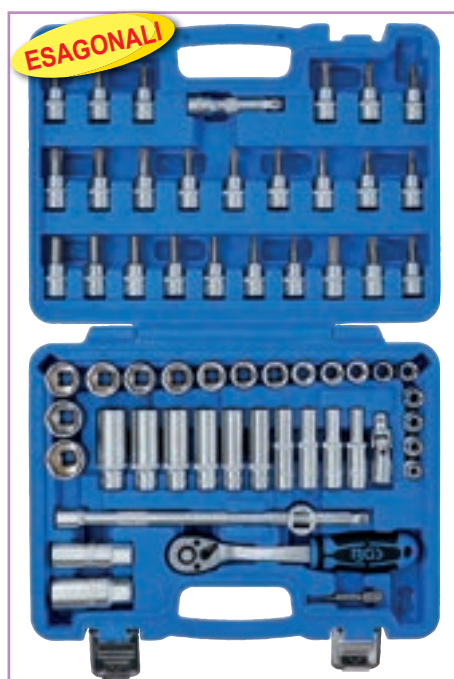

ESAGONALI



3/8"

PRO+



BGS articolo

DESCRIZIONE

BGS 2218

**SET 61 PEZZI,
UTENSILI ATT. 3/8"**

CARATTERISTICHE

- comprende i seguenti utensili attacco quadro 3/8":
 - cricchetto reversibile, 72 denti
 - prolunga, 75 mm
 - chiave a T con quadro scorrevole
 - snodo
 - adattatore esagonale 8 mm
 - bussole per candele 16 e 21 mm
 - 18 bussole esagonali: 6-8-9-10-11-12-13-14-15-17-19-20-21-22-24 mm
 - 10 bussole esagonali lunghe: 8-9-10-11-12-13-14-15-17-19 mm
 - 25 bussole maschio:
 - taglio: 5.5 - 7 - 8 mm
 - PH: 1 - 2 - 3
 - PZ: 1 - 2 - 3
 - esagonali: 3-4-5-6-7-8-10 mm
 - Torx: Tx15 - Tx20 - Tx27 - Tx25 - Tx30 - Tx40 - Tx45 - Tx50 - Tx55
- peso: 4,2 kg

SET 3/8"

BUSSOLE ESAGONALI
CV
 S2

CV

 1/4"-3/8"

PRO +
BGS
 articolo

DESCRIZIONE
BGS 2289
SET 92 PEZZI, BUSSOLE E ACCESSORI ATT. 1/4" - 3/8"
CARATTERISTICHE

- comprende i seguenti utensili attacco 1/4": - cricchetto reversibile 72 denti - bussole esagonali: 4 - 4,5 - 5 - 6 - 7 - 8 - 9 - 10 - 11 - 13 mm - bussole esagonali lunghe: 6 - 8 - 10 - 11 - 13 mm - 1 adattatore portainseriti - 1 impugnatura 150 mm - 1 snodo - 1 prolunga - 1 leva con quadro scorrevole
- comprende i seguenti utensili attacco 3/8": - cricchetto reversibile 72 denti - bussole esagonali: 14 - 15 - 16 - 17 - 19 - 20 - 21 - 22 - 23 - 24 mm - bussole esagonali lunghe: 14 - 16 - 17 - 19 mm - 1 adattatore portainseriti - 1 snodo - 1 prolunga - 3 bussole per candele: 16 - 18 - 21 mm - 1 riduzione quadro 3/8" Femmina - quadro 1/4" Maschio
- 29 inserti (S2): - Taglio: 2 - 2,5 - 3 - 4 - 5 - 6 - 7 mm - PH: PH0, PH1, PH2, PH3 - PZ: PZ0, PZ1, PZ2, PZ3 - Esagonali: 1,5 - 2 - 2,5 - 3 - 4 - 5 - 7 mm - Torx: TX10 - TX15 - TX20 - TX25 - TX27 - TX30 - TX40
- 9 chiavi combinate: 6 - 8 - 10 - 11 - 13 - 14 - 16 - 17 - 19 mm
- 9 chiavi a L esagonali: 1,5 - 2 - 2,5 - 3 - 4 - 5 - 6 - 8 - 10 mm
- peso: 5,6 kg

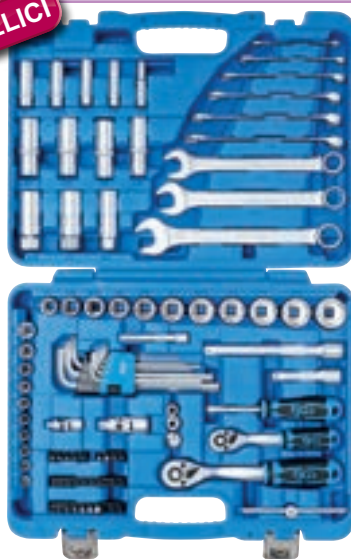
POLLICI

ideale per AUTO & MOTO inglesi e americane

 1/4"-3/8"

CV
PRO +
BGS
 articolo

DESCRIZIONE
BGS 2299
SET 92 PEZZI, BUSSOLE IN POLLICI, ATT. 1/4" - 3/8"
CARATTERISTICHE

- con bussole esagonali
- 2 chiavi a cricchetto a 72 denti 1/4" + 3/8"
- bussole corte, attacco 1/4": 5/32", 3/16", 7/32", 1/4", 9/32", 5/16", 11/32", 3/8", 7/16", 1/2"
- bussole lunghe, attacco 1/4": 1/4", 5/16", 3/8", 7/16", 1/2"
- adattatore inserto 1/4"
- 1 impugnatura con quadro 1/4" (6,3)
- 1 snodo 1/4"
- 1 barra di prolunga con esagono esterno, 1/4"
- 1 impugnatura scorrevole a T con adattatore 1/4"
- bussole corte, attacco da 3/8": 1/2", 9/16", 19/32", 5/8", 11/16", 3/4", 25/32", 13/16", 7/8", 15/16", 1"
- bussole lunghe, attacco da 3/8": 9/16", 5/8", 11/16", 3/4"
- adattatore inserto da 3/8"
- 1 snodo da 3/8"
- 1 barra di prolunga da 3/8"
- 3 bussole per candele: 5/8", 3/4", 13/16"
- assortimento di 29 pz. con Taglio, PH, PZ, Esagono, Torx
- set chiavi combinate da 9 pz.: 1/4", 5/16", 3/8", 7/16", 1/2", 9/16", 5/8", 11/16", 3/4"
- chiavi a Esagono: 1/16", 5/64", 3/32", 1/8", 5/32", 3/16", 1/4", 5/16", 3/8"
- 1 adattatore 1/4" M - 3/8" F
- peso: 4,9 kg

PRO +

1000 V
CV

 3/8"

BGS
 articolo

DESCRIZIONE
BGS 7130
SET 26 PEZZI, UTENSILI ISOLATI VDE, ATT. 3/8", IN VALIGETTA IN PLASTICA
CARATTERISTICHE

- conformi DIN EN 60900
- isolati VDE fino a 1000 V
- comprende i seguenti utensili isolati: - cricchetto reversibile, attacco 3/8" (BGS 701) - bussole, attacco quadro femmina 3/8", lunghezza 72 mm, Esagono: 7 - 8 - 10 - 12 - 14 - 15 - 17 - 19 - 22 mm - chiave a T, attacco quadro maschio 3/8", lunghezza 210 mm - prolunga, 100 mm - chiavi a forchetta: 7 x lung. 90 mm - 8 x lung. 100 mm - 10 x lung. 105 mm - 12 x lung. 125 mm - 14 x lung. 145 mm - 17 x lung. 190 mm - coltello per cavi - cacciaviti taglio: 4,0 X 100 - 5,5 X 125 - cacciaviti PH: PH1 X 100 - PH2 X 100 - tronchese taglio diagonale, 160 mm - pinze professionali, 180 mm
- peso: 4,3 kg



TORX® CON FORO TORX®

3/8" **ESAGONO 5/16" C** **PRO+** **CV**

BGS articolo	DESCRIZIONE
BGS 5021	SET 34 PEZZI, CHIAVI A BUSSOLA TORX, ATT. 3/8"

CARATTERISTICHE

- satinare cromate
- 11 chiavi a bussola attacco 3/8": T10 - T60
- 10 inserti Torx c/foro attacco 5/16": T10 - T55
- 1 adattatore per inserti attacco da 3/8"
- 12 bussole Torx E4 - E20
- peso: 1,3 kg



1/4" **3/8"** **1/2"** **TORX®** **PRO+**

BGS articolo	DESCRIZIONE
BGS 70099	SET 28 PEZZI, BUSSOLE TORX FEMMINA, E4 - E20, ATT. 1/4" - 3/8" - 1/2"

CARATTERISTICHE

- zigrinato
- finitura cromata satinata
- impronta Torx Femmina
- comprende:
 - attacco 1/4": E4 - E5 - E6 - E7 - E8 - E10 - E11
 - attacco 3/8": E4 - E5 - E6 - E7 - E8 - E10 - E11 E12 - E14 - E16 - E18 - E20
 - attacco 1/2": E4 - E5 - E6 - E7 - E8 - E10 - E11 E12 - E14 - E16 - E18 - E20
- peso: 1,3 kg



1/4"-3/8" **ESAGONO 5/16" C** **TORX® CON FORO** **PRO+** **CV**

BGS articolo	DESCRIZIONE
BGS 5023	SET 17 PEZZI, BUSSOLE E INSERTI TORX, ATT. 3/8"

CARATTERISTICHE

- bussole
 - attacco 1/4": E 6-7-8
 - attacco 3/8": E 10-12-14-16
- 9 inserti Torx c/foro attacco esagonale 5/16": TH 10-15-20-25-30-40-45-50-55
- adattatore portainseri attacco quadro 3/8" x 5/16" esagonale
- peso: 500 g

RICAMBI

BGS articolo	DESCRIZIONE
BGS 5023-LEER	CASSETTA VUOTA



1/4" **3/8"** **1/2"**

EPR 5 PT **TORXplus®** **TESLA**

FERMEC articolo	DESCRIZIONE
FM 16 EPR	SET 16 PEZZI, BUSSOLE TORX PLUS EPR 5 PT, 6 EPR - 32 EPR, ATT. 1/4" - 3/8" - 1/2"

CARATTERISTICHE

- zigrinato
- finitura cromata satinata
- impronta Torx Plus EPR 5 PT
- per Tesla
- comprende:
 - attacco 1/4", lunghezza 25 mm: 6 EPR - 7 EPR - 8 EPR - 10 EPR - 11 EPR
 - attacco 3/8", lunghezza 37 mm: 12 EPR - 14 EPR - 16 EPR - 18 EPR - 20 EPR
 - attacco 1/2", lunghezza 45 mm: 22 EPR - 24 EPR - 26 EPR - 28 EPR - 30 EPR - 32 EPR



SET 3/8"



3/8

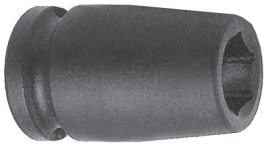

ESAGONO

BUSSOLE POWER IMPACT
 attacco: 3/8"
 impronta: ESAGONO

FEFMEC articolo	mm	L mm	
196-6	6	30	1
196-7	7	30	1
196-8	8	30	1
196-9	9	30	1
196-10	10	30	1
196-11	11	30	1
196-12	12	30	1
196-13	13	30	1
196-14	14	30	1
196-15	15	30	1
196-16	16	30	1
196-17	17	30	1
196-18	18	30	1
196-19	19	30	1
196-20	20	30	1
196-21	21	30	1
196-22	22	30	1
196-24	24	30	1

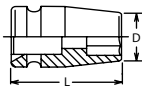

ESAGONO

**CHIAVI A BUSSOLA
 A MACCHINA
 BOCCA ESAGONALE**

Koken articolo	mm	D mm	L mm	
13400M-6	6	10.8	32	1
13400M-7	7	12	32	1
13400M-8	8	13.3	32	1
13400M-9	9	14.5	32	1
13400M-10	10	15.8	32	1
13400M-11	11	17	32	1
13400M-12	12	18.3	32	1
13400M-13	13	19.5	32	1
13400M-14	14	20.8	32	1
13400M-15	15	22	32	1
13400M-16	16	23.3	32	1
13400M-17	17	24.5	32	1
13400M-18	18	25.8	32	1
13400M-19	19	27	32	1
13400M-20	20	28.3	32	1
13400M-21	21	29.5	32	1
13400M-22	22	30.8	32	1
13400M-23	23	32	32	1
13400M-24	24	33.3	32	1



Koken articolo	DESCRIZIONE
13241 M	Set chiavi a bussola 11 Pezzi in cassetta metallica
RICAMBI	
BUSSOLE ESAGONO	13400M 9, 10, 11, 12, 13, 14, 15, 16, 17, 18, 19

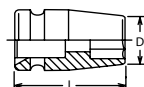

Koken articolo	DESCRIZIONE
13242 M	Set chiavi a bussola 11 Pezzi in cassetta metallica 310 x 90 x h 48 mm con scomparto portautensili vuoto
RICAMBI	
BUSSOLE ESAGONO	13400M 9, 10, 11, 12, 13, 14, 15, 16, 17, 18, 19

CON RIVESTIMENTO ANTI-GRAFFIO
**CHIAVI A BUSSOLA
 A MACCHINA
 BOCCA ESAGONALE
 CON RIVESTIMENTO**

Koken articolo	mm	D mm	L mm	
13400M-8FR	8	15.7	32	1
13400M-10FR	10	18.2	32	1
13400M-12FR	12	20.8	32	1
13400M-13FR	13	23.6	32	1
13400M-14FR	14	21.8	32	1
13400M-16FR	16	26.1	32	1
13400M-17FR	17	27.3	32	1

POLLICI

JAPAN

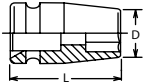

ESAGONO

**CHIAVI A BUSSOLA
 A MACCHINA
 BOCCA ESAGONALE**

Koken articolo	pollici	D mm	L mm	
13400A-1/4	1/4"	10.8	32	1
13400A-5/16	5/16"	13.3	32	1
13400A-3/8	3/8"	15.8	32	1
13400A-7/16	7/16"	17	32	1
13400A-1/2	1/2"	19.5	32	1
13400A-9/16	9/16"	20.8	32	1
13400A-5/8	5/8"	23.3	32	1
13400A-11/16	11/16"	24.5	32	1
13400A-3/4	3/4"	27	32	1
13400A-13/16	13/16"	29.5	32	1
13400A-7/8	7/8"	30.8	32	1

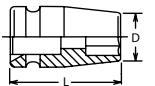

ESAGONO

**CHIAVI A BUSSOLA
 A MACCHINA
 BOCCA ESAGONALE
 PARETI SOTTILI**

Koken articolo	mm	D mm	L mm	
13401M-6	6	9.8	32	1
13401M-7	7	11	32	1
13401M-8	8	12.3	32	1
13401M-9	9	13.5	32	1
13401M-10	10	14.8	32	1
13401M-11	11	16	32	1
13401M-12	12	17.3	32	1
13401M-13	13	18.5	32	1
13401M-14	14	19.8	32	1
13401M-15	15	21	32	1
13401M-16	16	22.3	32	1
13401M-17	17	23.5	32	1
13401M-18	18	24.8	32	1
13401M-19	19	26	32	1
13401M-20	20	27.3	32	1
13401M-21	21	28.5	32	1
13401M-22	22	29.8	32	1
13401M-23	23	31	32	1
13401M-24	24	32.3	32	1

JAPAN



ESAGONO

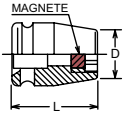

CHIAVI A BUSSOLA A MACCHINA BOCCA ESAGONALE CON MAGNETE

Koken articolo	mm	D mm	L mm	
13400MG-6	6	10.8	32	1
13400MG-7	7	12	32	1
13400MG-8	8	13.3	32	1
13400MG-9	9	14.5	32	1
13400MG-10	10	15.8	32	1
13400MG-11	11	17	32	1
13400MG-12	12	18.3	32	1
13400MG-13	13	19.5	32	1
13400MG-14	14	20.8	32	1
13400MG-15	15	22	32	1
13400MG-16	16	23.3	32	1
13400MG-17	17	24.5	32	1
13400MG-18	18	25.8	32	1
13400MG-19	19	27	32	1
13400MG-21	21	29.5	32	1
13400MG-22	22	30.8	32	1

JAPAN



ESAGONO

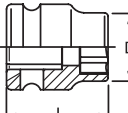

CHIAVI A BUSSOLA A MACCHINA EXTRA CORTE RIBASSATE BOCCA ESAGONALE

Koken articolo	mm	D mm	L mm	
13401MS-8	8	12.3	22	1
13401MS-10	10	14.8	22	1
13401MS-11	11	16	22	1
13401MS-12	12	17.3	22	1
13401MS-13	13	18.5	22	1
13401MS-14	14	19.8	22	1
13401MS-15	15	20.9	25	1
13401MS-16	16	22.3	25	1
13401MS-17	17	23.5	25	1
13401MS-18	18	24.8	25	1
13401MS-19	19	26	25	1

JAPAN

POLLICI



POLIGONALE

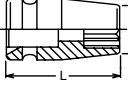

CHIAVI A BUSSOLA A MACCHINA BOCCA POLIGONALE

Koken articolo	pollici	D mm	L mm	
13405A-1/4	1/4"	10.8	32	1
13405A-5/16	5/16"	13.3	32	1
13405A-3/8	3/8"	15.8	32	1
13405A-7/16	7/16"	17	32	1
13405A-1/2	1/2"	19.5	32	1
13405A-9/16	9/16"	20.8	32	1
13405A-5/8	5/8"	23.3	32	1
13405A-11/16	11/16"	24.5	32	1
13405A-3/4	3/4"	27	32	1
13405A-13/16	13/16"	29.5	32	1
13405A-7/8	7/8"	30.8	32	1

POLLICI

JAPAN



ESAGONO



CHIAVI A BUSSOLA A MACCHINA BOCCA ESAGONALE CON MAGNETE

novità

Koken articolo	pollici	D mm	L mm	
13400AG-1/4	1/4"	10.8	32	1
13400AG-5/16	5/16"	13.3	32	1
13400AG-11/32	11/32"	14.5	32	1
13400AG-3/8	3/8"	15.8	32	1
13400AG-7/16	7/16"	17	32	1
13400AG-1/2	1/2"	19.5	32	1
13400AG-9/16	9/16"	20.8	32	1
13400AG-5/8	5/8"	23.3	32	1
13400AG-11/16	11/16"	24.5	32	1
13400AG-3/4	3/4"	27	32	1

JAPAN



POLIGONALE

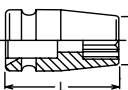

CHIAVI A BUSSOLA A MACCHINA BOCCA POLIGONALE

Koken articolo	mm	D mm	L mm	
13405M-8	8	13.3	32	1
13405M-9	9	14.5	32	1
13405M-10	10	15.8	32	1
13405M-11	11	17	32	1
13405M-12	12	18.3	32	1
13405M-13	13	19.5	32	1
13405M-14	14	20.8	32	1
13405M-15	15	22	32	1
13405M-16	16	23.3	32	1
13405M-17	17	24.5	32	1
13405M-18	18	25.8	32	1
13405M-19	19	27	32	1

JAPAN

PARETI SOTTILI



POLIGONALE

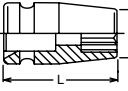

CHIAVI A BUSSOLA A MACCHINA BOCCA POLIGONALE PARETI SOTTILI

Koken articolo	mm	D mm	L mm	
13406M-6	6	9.8	32	1
13406M-7	7	11	32	1
13406M-8	8	12.3	32	1
13406M-9	9	13.5	32	1
13406M-10	10	14.8	32	1
13406M-11	11	16	32	1
13406M-12	12	17.3	32	1
13406M-13	13	18.5	32	1
13406M-14	14	19.8	32	1
13406M-15	15	21	32	1
13406M-16	16	22.3	32	1
13406M-17	17	23.5	32	1
13406M-18	18	24.8	32	1
13406M-19	19	26	32	1
13406M-20	20	27.3	32	1
13406M-21	21	28.5	32	1
13406M-22	22	29.8	32	1
13406M-23	23	31	32	1
13406M-24	24	32.3	32	1

IMPACT 3/8"

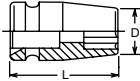

**CHIAVI A BUSSOLA
A MACCHINA BOCCA
SURFACE DRIVE**

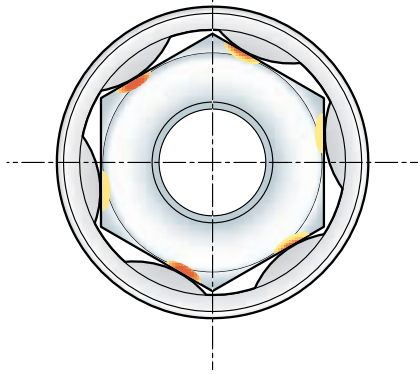
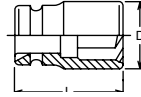
<i>Kokon</i> articolo	mm	D mm	L mm	
13410M-6	6	10.8	32	1
13410M-7	7	12	32	1
13410M-8	8	13.3	32	1
13410M-9	9	14.5	32	1
13410M-10	10	15.8	32	1
13410M-11	11	17	32	1
13410M-12	12	18.3	32	1
13410M-13	13	19	32	1
13410M-14	14	20.8	32	1
13410M-15	15	22	32	1
13410M-16	16	23.3	32	1
13410M-17	17	24.5	32	1
13410M-18	18	25.8	32	1
13410M-19	19	27	32	1
13410M-22	22	30.8	32	1

BUSSOLE SURFACE DRIVE

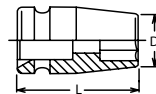
**CHIAVI A BUSSOLA
A MACCHINA BOCCA
FAST LEAD**



<i>Kokon</i> articolo	mm	D mm	L mm	
13465M-8	8	13.3	32	1
13465M-10	10	15.8	32	1
13465M-11	11	17	32	1
13465M-12	12	18.3	32	1
13465M-13	13	19.5	32	1
13465M-14	14	20.8	32	1
13465M-15	15	22	32	1
13465M-16	16	23.3	32	1
13465M-17	17	24.5	32	1
13465M-18	18	25.8	32	1
13465M-19	19	27	32	1

**CHIAVI A BUSSOLA
A MACCHINA BOCCA
LHSTIX®**

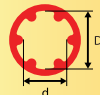
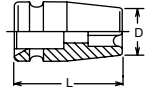

<i>Kokon</i> articolo	mm	D mm	L mm	
13401LH-5S	5S	11	32	1
13401LH-6S	6S	12.3	32	1
13401LH-8S	8S	16	32	1
13401LH-10S	10S	18.5	32	1
13401LH-12S	12S	22.3	32	1
13401LH-14S	14S	24.8	32	1
13401LH-16S	16S	28.5	32	1

LHSTIX®	d mm	D mm
LH 3 S	3.80	4.70
LH 4 S	4.50	6.00
LH 5 S	5.60	7.50
LH 6 S	6.80	9.00
LH 7 S	7.90	10.50
LH 8 S	9.00	12.00
LH 10 S	11.30	15.00
LH 12 S	13.60	18.00
LH 14 S	15.80	21.00
LH 16 S	18.10	24.00



**CHIAVI A BUSSOLA
A MACCHINA BOCCA
TORX®**

<i>Kokon</i> articolo	mm	D mm	L mm	
13425-E 4	E 4	9.7	32	1
13425-E 5	E 5	10.2	32	1
13425-E 6	E 6	10.7	32	1
13425-E 7	E 7	11.2	32	1
13425-E 8	E 8	11.7	32	1
13425-E10	E 10	12.2	32	1
13425-E11	E 11	13.2	32	1
13425-E12	E 12	14.2	32	1
13425-E14	E 14	17.2	32	1
13425-E16	E 16	18.2	32	1

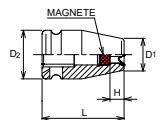

FEARMEC articolo	DESCRIZIONE
611092	Set chiavi a bussola 9 Pezzi in cassetta metallica
CARATTERISTICHE	
	E 5-6-7-8-10-11-12-14-16

**CHIAVI A BUSSOLA
A MACCHINA BOCCA
TORX®
CON MAGNETE**

<i>Kokon</i> articolo	mm	D mm	L mm	
13425EG-E8	E 8	11.7	32	1
13425EG-E10	E 10	12.2	32	1
13425EG-E12	E 12	14.2	32	1
13425EG-E14	E 14	17.2	32	1

JAPAN



TORXplus

CHIAVI A BUSSOLA A MACCHINA BOCCA TORX PLUS®

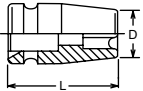

Koken articolo	D mm	L mm	1
13425-8EPL	E 8 12	32	1
13425-10EPL	E 10 13.3	32	1
13425-12EPL	E 12 15.8	32	1
13425-14EPL	E 14 18.3	32	1
13425-16EPL	E 16 19.5	32	1



FERMEC FM15TPE

1/4" 3/8" 1/2" **TORXplus**

articolo	DESCRIZIONE
FM 15 TPE	SET 15 PEZZI, BUSSOLE TORX PLUS, IMPACT ATT. 1/4" - 3/8" - 1/2", 6 EPL - 32 EPL

- CARATTERISTICHE**
- impact
 - impronta Torx Plus
 - comprende:
 - attacco 1/4", lunghezza 25 mm: 6 EPL - 7 EPL - 8 EPL
 - attacco 3/8", lunghezza 37 mm: 10 EPL - 12 EPL - 14 EPL - 16 EPL
 - attacco 1/2", lunghezza 45 mm: 18 EPL - 20 EPL - 22 EPL - 24 EPL - 26 EPL - 28 EPL - 30 EPL - 32 EPL

TORX PLUS®		S mm	S mm
E 4	E 16	3.70	14.60
E 5	E 18	4.60	16.50
E 6	E 20	5.60	18.30
E 7	E 22	6.10	20.10
E 8	E 24	7.40	22.00
E 10	E 26	9.30	23.70
E 11	E 28	9.90	25.50
E 12	E 30	11.00	27.30
E 14	E 32	12.80	29.00

JAPAN



CHIAVI A BUSSOLA A MACCHINA BOCCA QUADRA

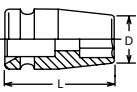

Koken articolo	mm	D mm	L mm	1
13400WN-6	6	15.8	32	1
13400WN-8	8	18.3	32	1
13400WN-9	9	19.5	32	1
13400WN-10	10	20.8	32	1
13400WN-12	12	24.5	32	1
13400WN-14	14	27	32	1
13400WN-17	17	32	32	1

JAPAN

PARETI SOTTILI SU TUTTO IL CORPO



ESAGONO

CHIAVI A BUSSOLA POWER BOCCA ESAGONALE

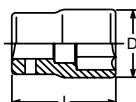

Koken articolo	mm	D mm	L mm	1
23400M-6	6	9.9	26	1
23400M-7	7	10.8	26	1
23400M-8	8	13.9	26	1
23400M-10	10	14.5	26	1
23400M-11	11	15.8	26	1
23400M-12	12	16.8	26	1
23400M-13	13	18	26	1
23400M-14	14	19.5	27	1
23400M-15	15	20.8	28	1
23400M-16	16	22	28	1
23400M-17	17	23.4	29	1
23400M-18	18	24.5	30	1
23400M-19	19	25.8	30	1
23400M-21	21	28	32	1

JAPAN

PARETI SOTTILI SU TUTTO IL CORPO

POLLICI



ESAGONO

CHIAVI A BUSSOLA POWER BOCCA ESAGONALE



Koken articolo	pollici	D mm	L mm	1
23400A-5/16	5/16"	12	26	1
23400A-3/8	3/8"	13.9	26	1
23400A-7/16	7/16"	15.8	26	1
23400A-1/2	1/2"	18	26	1
23400A-9/16	9/16"	19.5	27	1
23400A-11/16	11/16"	24.5	30	1
23400A-3/4	3/4"	25.8	30	1

JAPAN

PARETI SOTTILI SU TUTTO IL CORPO



POLIGONALE

CHIAVI A BUSSOLA POWER BOCCA POLIGONALE



Koken articolo	mm	D mm	L mm	1
23405M-8	8	12	26	1
23405M-10	10	14.5	26	1
23405M-12	12	16.8	26	1
23405M-14	14	19.5	27	1

JAPAN

PARETI SOTTILI SU TUTTO IL CORPO



SURFACE DRIVE

CHIAVI A BUSSOLA POWER BOCCA SURFACE DRIVE

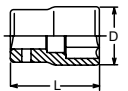

Koken articolo	mm	D mm	L mm	1
23410M-8	8	12	26	1
23410M-10	10	14.5	26	1
23410M-12	12	16.8	26	1
23410M-13	13	18	26	1
23410M-14	14	19.5	27	1
23410M-15	15	21	28	1
23410M-16	16	22	28	1
23410M-17	17	23.5	29	1
23410M-18	18	24.6	30	1
23410M-19	19	26	30	1

BUSSOLE SURFACE DRIVE

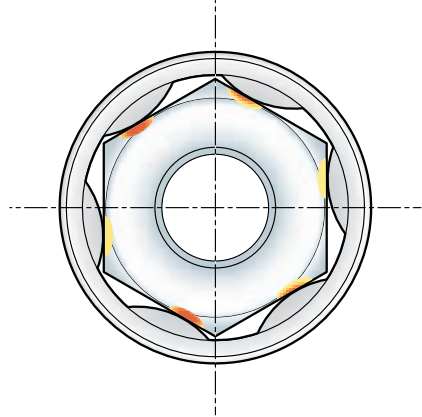



IMPACT 3/8"

PARETI SOTTILI
 SU TUTTO IL CORPO

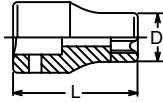
JAPAN

 CHIAVI A BUSSOLA
 POWER
 BOCCA TORX®

Koken articolo		D mm	L mm	
23425-E 5	E 5	10.2	26	1
23425-E 6	E 6	10.7	26	1
23425-E 7	E 7	11.2	26	1
23425-E 8	E 8	11.7	26	1
23425-E10	E 10	12.2	26	1
23425-E11	E 11	13.3	26	1
23425-E12	E 12	14.2	26	1
23425-E14	E 14	17.2	26	1
23425-E16	E 16	18.2	26	1

TORX®

	S mm	S mm	
E 4	3.70	E 16	14.60
E 5	4.60	E 18	16.50
E 6	5.60	E 20	18.30
E 7	6.10	E 22	20.10
E 8	7.40	E 24	22.00
E 10	9.30	E 26	23.70
E 11	9.90	E 28	25.50
E 12	11.00	E 30	27.30
E 14	12.80	E 32	29.00



S





3/8



ESAGONO

LUNGHE



 attacco: 3/8"
 impronta: ESAGONO

#FERMEC articolo		L mm	
196-8 L	8	65	1
196-9 L	9	65	1
196-10 L	10	65	1
196-11 L	11	65	1
196-12 L	12	65	1
196-13 L	13	65	1
196-14 L	14	65	1
196-15 L	15	65	1
196-16 L	16	65	1
196-17 L	17	65	1
196-18 L	18	65	1
196-19 L	19	65	1
196-20 L	20	65	1
196-21 L	21	65	1
196-22 L	22	65	1

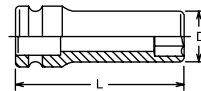

ESAGONO

 CHIAVI A BUSSOLA
 A MACCHINA BOCCA
 ESAGONALE
 TIPO LUNGO



Koken articolo		D mm	L mm	
13300M-6	6	10.8	80	1
13300M-7	7	12	80	1
13300M-8	8	13.3	80	1
13300M-9	9	14.5	80	1
13300M-10	10	15.8	80	1
13300M-11	11	17	80	1
13300M-12	12	18.3	80	1
13300M-13	13	19.5	80	1
13300M-14	14	20.8	80	1
13300M-15	15	22	80	1
13300M-16	16	23.3	80	1
13300M-17	17	24.5	80	1
13300M-18	18	25.8	80	1
13300M-19	19	27	80	1
13300M-20	20	28.3	80	1
13300M-21	21	29.5	80	1
13300M-22	22	30.8	80	1
13300M-23 <small>novità</small>	23	31.9	80	1
13300M-24	24	33.2	80	1

POLLICI

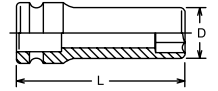

ESAGONO



 CHIAVI A BUSSOLA
 A MACCHINA BOCCA
 ESAGONALE
 TIPO LUNGO

Koken articolo		D mm	L mm	
13300A-1/4	1/4"	10.8	80	1
13300A-5/16	5/16"	13.3	80	1
13300A-3/8	3/8"	15.8	80	1
13300A-7/16	7/16"	17	80	1
13300A-1/2	1/2"	19.5	80	1
13300A-9/16	9/16"	20.8	80	1
13300A-5/8	5/8"	23.3	80	1
13300A-11/16	11/16"	24.5	80	1
13300A-3/4	3/4"	27	80	1
13300A-13/16	13/16"	29.5	80	1
13300A-7/8	7/8"	30.8	80	1

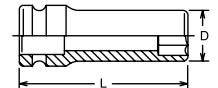

ESAGONO

 CHIAVI A BUSSOLA
 A MACCHINA BOCCA
 ESAGONALE
 TIPO LUNGO
 PARETI SOTTILI

Koken articolo		D mm	L mm	
13301M-6	6	10	80	1
13301M-7	7	11	80	1
13301M-8	8	12.3	80	1
13301M-9	9	13.5	80	1
13301M-10	10	14.8	80	1
13301M-11	11	16	80	1
13301M-12	12	17.3	80	1
13301M-13	13	18.5	80	1
13301M-14	14	19.8	80	1
13301M-15	15	21	80	1
13301M-16	16	22.3	80	1
13301M-17	17	23.5	80	1
13301M-18	18	24.8	80	1
13301M-19	19	26	80	1
13301M-20	20	23.7	80	1
13301M-21	21	28.5	80	1
13301M-22	22	29.8	80	1
13301M-24	24	32.3	80	1



JAPAN

ESAGONO

CON RIVESTIMENTO ANTI-GRAFFIO

CHIAVI A BUSSOLA
A MACCHINA
BOCCA ESAGONALE
TIPO LUNGO
CON RIVESTIMENTO
IN PLASTICA
ANTIGRAFFIO

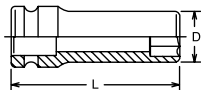

Koken articolo	mm	D mm	L mm	
13300M-8FR	8	16.1	81.3	1
13300M-10FR	10	18.6	81.3	1
13300M-12FR	12	21.1	81.3	1
13300M-13FR	13	22.3	81.3	1
13300M-14FR	14	23.6	81.3	1
13300M-16FR	16	26.0	81.3	1
13300M-17FR	17	27.2	81.3	1

PARETI SOTTILI

SEMI-LUNGA



JAPAN

ESAGONO

CHIAVI A BUSSOLA
A MACCHINA
BOCCA ESAGONALE
PARETI SOTTILI
TIPO SEMI-LUNGO

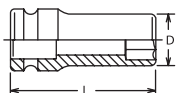

Koken articolo	mm	D mm	L mm	
13301X-6 <i>novità</i>	6	9.8	50	1
13301X-7	7	11	50	1
13301X-8	8	12.3	50	1
13301X-10	10	14.8	50	1
13301X-11	11	16	50	1
13301X-12	12	17.3	50	1
13301X-13	13	18.5	50	1
13301X-14	14	19.8	50	1
13301X-15	15	21	50	1
13301X-16	16	22.3	50	1
13301X-17	17	23.5	50	1
13301X-18	18	24.8	50	1
13301X-19	19	26	50	1
13301X-21	21	28.5	50	1
13301X-22	22	29.8	50	1
13301X-23	23	31	50	1
13301X-24	24	32.3	50	1



JAPAN

ESAGONO



CHIAVI A BUSSOLA
A MACCHINA BOCCA
ESAGONALE
CON MAGNETE
RETRATTILE

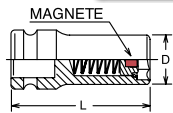

Koken articolo	mm	D mm	L mm	
13300XC-7	7	12	50	1
13300XC-8	8	13.3	50	1
13300XC-10	10	15.8	50	1
13300XC-11	11	17	50	1
13300XC-12	12	18.3	50	1
13300XC-13	13	19.5	50	1
13300XC-14	14	20.8	50	1
13300XC-16	16	23.2	50	1
13300XC-17	17	24.4	50	1
13300G-8	8	13.3	80	1
13300G-10	10	15.8	80	1
13300G-12	12	18.3	80	1
13300G-13	13	19.5	80	1
13300G-14	14	20.8	80	1
13300G-15	15	22	80	1
13300G-16	16	23.3	80	1
13300G-17	17	24.5	80	1
13300G-19	19	27	80	1



JAPAN

SURFACE
DRIVE

CHIAVI A BUSSOLA
A MACCHINA BOCCA
SURFACE DRIVE
TIPO LUNGO

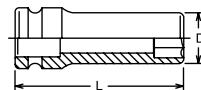

Koken articolo	mm	D mm	L mm	
13310M-7	7	11	80	1
13310M-8	8	13.3	80	1
13310M-9	9	14.5	80	1
13310M-10	10	15.8	80	1
13310M-11	11	17	80	1
13310M-12	12	18.3	80	1
13310M-13	13	19.5	80	1
13310M-14	14	20.8	80	1
13310M-15	15	22	80	1
13310M-16	16	23.3	80	1
13310M-17	17	24.5	80	1
13310M-18	18	25.8	80	1
13310M-19	19	27	80	1

BUSSOLE SURFACE DRIVE

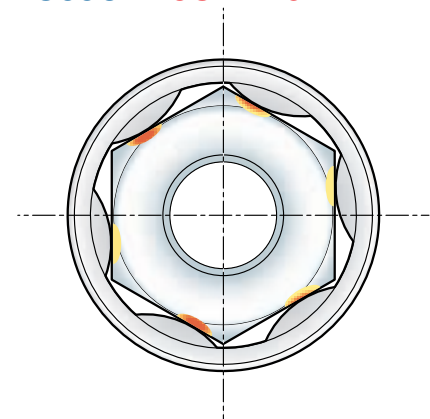

JAPAN

ESAGONO



CON RIVESTIMENTO ANTI-GRAFFIO

CHIAVI A BUSSOLA
A MACCHINA
BOCCA ESAGONALE
TIPO LUNGO
CON MAGNETE
RETRATTILE
CON RIVESTIMENTO
IN PLASTICA
ANTIGRAFFIO

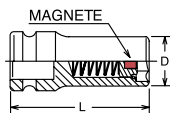

Koken articolo	mm	D mm	L mm	
13300G-8FR	8	16.1	81.3	1
13300G-10FR	10	18.6	81.3	1
13300G-12FR	12	21.1	81.3	1
13300G-13FR	13	22.3	81.3	1
13300G-14FR	14	23.6	81.3	1
13300G-16FR	16	26.0	81.3	1
13300G-17FR	17	27.2	81.3	1

IMPACT 3/8"



FAST LEAD

CHIAVI A BUSSOLA
A MACCHINA BOCCA
FAST LEAD
TIPO LUNGO

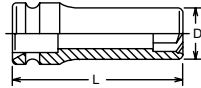

Koken articolo	mm	D mm	L mm		
13365M-8	8	13.3	80	1	
13365M-10	10	15.8	80	1	
13365M-11	11	17	80	1	
13365M-12	12	18.3	80	1	
13365M-13	13	19.5	80	1	
13365M-14	14	20.8	80	1	
13365M-15	15	22	80	1	
13365M-16	16	23.3	80	1	
13365M-17	17	24.5	80	1	
13365M-18	18	25.8	80	1	
13365M-19	19	27	80	1	

JAPAN
PARETI SOTTILI



POLIGONALE

CHIAVI A BUSSOLA
A MACCHINA
BOCCA POLIGONALE
TIPO LUNGO
PARETI SOTTILI

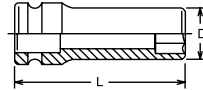

Koken articolo	mm	D mm	L mm		
13306M-8	8	12.3	80	1	
13306M-10	10	14.8	80	1	
13306M-11	11	16	80	1	
13306M-12	12	17.3	80	1	
13306M-13	13	18.5	80	1	
13306M-14	14	19.8	80	1	
13306M-17	17	23.5	80	1	

JAPAN
PARETI SOTTILI
SU TUTTO IL CORPO



ESAGONO

CHIAVI A BUSSOLA
POWER
BOCCA ESAGONALE
TIPO LUNGO

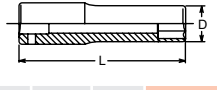

Koken articolo	mm	D mm	L mm		
23300M-7	7	10.6	55	1	
23300M-8	8	12	55	1	
23300M-10	10	14.5	55	1	
23300M-11	11	16	55	1	
23300M-12	12	16.8	55	1	
23300M-13	13	18	55	1	
23300M-14	14	20	55	1	
23300M-15	15	21	55	1	
23300M-16	16	22	55	1	
23300M-17	17	23.5	55	1	
23300M-18	18	24.5	55	1	
23300M-19	19	25	55	1	



POLIGONALE

CHIAVI A BUSSOLA
A MACCHINA BOCCA
POLIGONALE
TIPO LUNGO

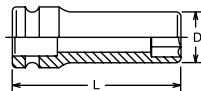

Koken articolo	mm	D mm	L mm		
13305M-8	8	13.3	80	1	
13305M-10	10	15.8	80	1	
13305M-11	11	17	80	1	
13305M-12	12	18.3	80	1	
13305M-13	13	19.5	80	1	
13305M-14	14	20.8	80	1	
13305M-17	17	24.5	80	1	



TORX®

CHIAVI A BUSSOLA
A MACCHINA
BOCCA TORX®
TIPO LUNGO

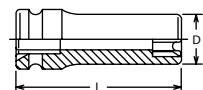

Koken articolo		D mm	L mm		
13325-E7	E 7	11.2	80	1	
13325-E8	E 8	11.7	80	1	
13325-E10	E 10	12.2	80	1	
13325-E12	E 12	14.2	80	1	
13325-E14	E 14	17.2	80	1	
13325-E16	E 16	18.2	80	1	

JAPAN
PARETI SOTTILI
SU TUTTO IL CORPO



ESAGONO

CHIAVI A BUSSOLA
POWER BOCCA
ESAGONALE
TIPO LUNGO

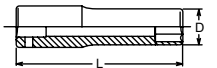

Koken articolo	pollici	D mm	L mm		
23300A-5/16	5/16"	12	55	1	
23300A-3/8	3/8"	14	55	1	
23300A-7/16	7/16"	16	55	1	
23300A-1/2	1/2"	18	55	1	
23300A-9/16	9/16"	20	55	1	
23300A-11/16	11/16"	23.5	55	1	
23300A-3/4	3/4"	25	55	1	

POLLICI

JAPAN

PARETI SOTTILI
SU TUTTO IL CORPO

JAPAN



POLIGONALE

CHIAVI A BUSSOLA
POWER
BOCCA POLIGONALE
TIPO LUNGO

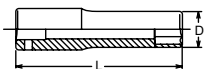

Koken articolo	mm	D mm	L mm	
23305M-8	8	12	55	1
23305M-10	10	14.5	55	1
23305M-12	12	16.8	55	1
23305M-14	14	20	55	1

PARETI SOTTILI
SU TUTTO IL CORPO

JAPAN



**SURFACE
DRIVE**

CHIAVI A BUSSOLA
POWER
BOCCA SURFACE
DRIVE TIPO LUNGO

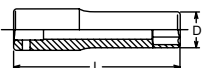

Koken articolo	mm	D mm	L mm	
23310M-8	8	12	55	1
23310M-10	10	14.5	55	1
23310M-12	12	16.8	55	1
23310M-13	13	18	55	1
23310M-14	14	19.5	55	1
23310M-15	15	21	55	1
23310M-17	17	23.5	55	1

BUSSOLE SURFACE DRIVE

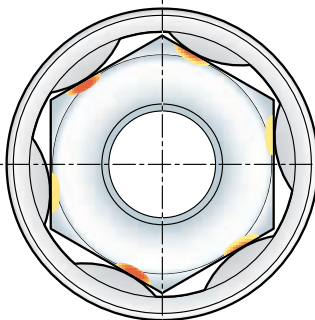

PARETI SOTTILI
SU TUTTO IL CORPO

JAPAN



TORX®

CHIAVI A BUSSOLA
POWER
BOCCA TORX®
TIPO LUNGO

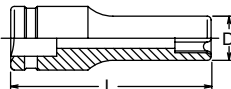

Koken articolo		D mm	L mm	
23325-E 5	E 5	10.2	55	1
23325-E 6	E 6	10.7	55	1
23325-E 7	E 7	11.2	55	1
23325-E 8	E 8	11.7	55	1
23325-E10	E 10	12.2	55	1
23325-E12	E 12	14.2	55	1
23325-E14	E 14	17.2	55	1
23325-E16	E 16	18.2	55	1



ESAGONO

CHIAVI A BUSSOLA
A MACCHINA BOCCA
ESAGONALE
TIPO EXTRA LUNGO



Koken articolo	mm	D mm	L mm	
13145M-100-8	8	13.3	100	1
13145M-100-10	10	15.8	100	1
13145M-100-12	12	18.3	100	1
13145M-100-13	13	19.5	100	1
13145M-100-14	14	20.8	100	1
13145M-100-17	17	24.5	100	1
13145M-150-6	6	10.8	150	1
13145M-150-8	8	13.3	150	1
13145M-150-10	10	15.8	150	1
13145M-150-12	12	18.3	150	1
13145M-150-13	13	19.5	150	1
13145M-150-14	14	20.8	150	1
13145M-150-15	15	22	150	1
13145M-150-17	17	24.5	150	1
13145M-200-6	6	10.8	200	1
13145M-200-8	8	13.3	200	1
13145M-200-10	10	15.8	200	1
13145M-200-12	12	18.3	200	1
13145M-200-13	13	19.5	200	1
13145M-200-14	14	20.8	200	1
13145M-200-15	15	22	200	1
13145M-200-17	17	24.5	200	1
13145M-250-6	6	10.8	250	1
13145M-250-8	8	13.3	250	1
13145M-250-10	10	15.8	250	1
13145M-250-12	12	18.3	250	1
13145M-250-13	13	19.5	250	1
13145M-250-14	14	20.8	250	1
13145M-250-15	15	22	250	1
13145M-250-17	17	24.5	250	1
13145A-150-9/16	9/16"	20	150	1

POLLICI



ESAGONO



JAPAN

CHIAVI A
BUSSOLA
A MACCHINA
BOCCA
ESAGONALE
TIPO EXTRA
LUNGO CON
MAGNETE

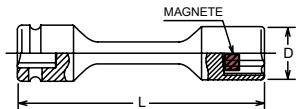

Koken articolo	mm	D mm	L mm	
13145MG-100-8	8	13.3	100	1
13145MG-100-10	10	15.8	100	1
13145MG-100-12	12	18.3	100	1
13145MG-100-13	13	20.8	100	1
13145MG-100-14	14	20.8	100	1
13145MG-150-8	8	13.3	150	1
13145MG-150-10	10	15.8	150	1
13145MG-150-12	12	18.3	150	1
13145MG-150-13	13	20.8	150	1
13145MG-150-14	14	24.5	150	1
13145MG-200-10	10	15.8	200	1
13145MG-200-12	12	18.3	200	1
13145MG-200-13	13	20.8	200	1
13145MG-200-14	14	24.5	200	1



POLIGONALE

CHIAVI A
BUSSOLA
A MACCHINA
BOCCA
POLIGONALE 12
PUNTI
EXTRA LUNGHE

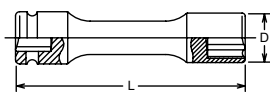

Koken articolo	mm	D mm	L mm	
13145M-100-12P-10	10	15.8	100	1
13145M-100-12P-12	12	18.3	100	1
13145M-150-12P-10	10	15.8	150	1
13145M-150-12P-12	12	18.3	150	1
13145M-200-12P-10	10	15.8	200	1
13145M-200-12P-12	12	18.3	200	1

JAPAN

IMPACT 3/8"



ESAGONO

JAPAN

CHIAVI A BUSSOLA
A MACCHINA
BOCCA
ESAGONALE
TIPO EXTRA
LUNGO SNODATA



Koken articolo	mm	D mm	L mm	
13146M-150-8	8	12	150	1
13146M-150-10	10	14.3	150	1
13146M-150-12	12	18	150	1
13146M-150-13	13	19.3	150	1
13146M-150-14	14	20	150	1
13146M-200-8	8	12	200	1
13146M-200-10	10	14.3	200	1
13146M-200-12	12	18	200	1
13146M-200-13	13	19.3	200	1
13146M-200-14	14	20	200	1
13146M-250-8	8	12	250	1
13146M-250-10	10	14.3	250	1
13146M-250-12	12	18	250	1
13146M-250-13	13	19.3	250	1
13146M-250-14	14	20	250	1

POLLICI



ESAGONO

JAPAN

CHIAVI A BUSSOLA
A MACCHINA
SNODATE
BOCCA ESAGONALE

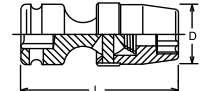

Koken articolo	pollici	D mm	L mm	
13440A-3/8	3/8"	15.8	57	1
13440A-7/16	7/16"	17	57	1
13440A-1/2	1/2"	19.5	57	1
13440A-9/16	9/16"	20.8	59	1
13440A-5/8	5/8"	23.3	59	1
13440A-11/16	11/16"	24.5	59	1
13440A-3/4	3/4"	27	61	1



3/8"

JAPAN

CHIAVE A BUSSOLA PER VITI E DADI CON
ALLETTE - GALLETTO

Koken articolo	T mm	φ mm	L mm	
BD 018	7,3	21	45	1

IMPACT 3/8"



ESAGONO

JAPAN

CHIAVI A BUSSOLA
A MACCHINA
SNODATE
BOCCA ESAGONALE

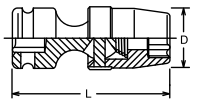

Koken articolo	mm	D mm	L mm	
13440M-10	10	15.8	57	1
13440M-11	11	17	57	1
13440M-12	12	18.3	57	1
13440M-13	13	19.5	57	1
13440M-14	14	20.8	59	1
13440M-15	15	22	59	1
13440M-16	16	23.3	59	1
13440M-17	17	24.5	59	1
13440M-18	18	25.8	61	1
13440M-19	19	27	61	1
13440M-20	20	29.5	65	1
13440M-21	21	30.7	65	1
13440M-22	22	32	65	1
13440M-24	24	34.5	67	1



TORX®

JAPAN

CHIAVI A BUSSOLA
A MACCHINA
SNODATE
BOCCA TORX

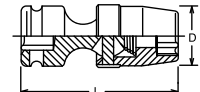

Koken articolo		D mm	L mm	
13440T-E10	E 10	13.3	57.7	1
13440T-E12	E 12	15.8	57.7	1
13440T-E14	E 14	17	57.7	1

TORX®	S mm	S mm	
E 4	3.70	E 16	14.60
E 5	4.60	E 18	16.50
E 6	5.60	E 20	18.30
E 7	6.10	E 22	20.10
E 8	7.40	E 24	22.00
E 10	9.30	E 26	23.70
E 11	9.90	E 28	25.50
E 12	11.00	E 30	27.30
E 14	12.80	E 32	29.00



3/8

ESAGONO

BUSSOLE ESAGONALI MASCHIO INTEGRALI
attacco: 3/8"
impronta: ESAGONO MASCHIO

FEEMEC articolo	mm	L mm	
182R - 3/8" - 5 - 25 novita	5	25	1
182 - 3/8" - 4 - 36	4	36	1
182 - 3/8" - 5 - 36	5	36	1
182 - 3/8" - 6 - 36	6	36	1
182 - 3/8" - 8 - 36	8	36	1
182 - 3/8" - 10 - 36	10	36	1
182 - 3/8" - 4	4	50	1
182 - 3/8" - 5	5	50	1
182 - 3/8" - 6	6	50	1
182 - 3/8" - 7	7	50	1
182 - 3/8" - 8	8	50	1
182 - 3/8" - 10	10	50	1
182 - 3/8" - 12	12	50	1
182 - 3/8" - 14	14	50	1
1182 - 3/8" - 4	4	90	1
1182 - 3/8" - 5	5	90	1
1182 - 3/8" - 6	6	90	1
1182 - 3/8" - 8	8	90	1
2182 - 3/8" - 8	8	125	1
3182 - 3/8" - 6 novita	6	150	1

JAPAN



ESAGONO

CHIAVI A BUSSOLA A MACCHINA MASCHIO ESAGONALE - INTEGRALI

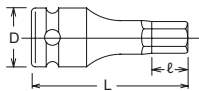

Koken articolo	mm	D mm	l mm	L mm	
13012M-52-3	3	18	10	52	1
13012M-52-4	4	18	15.5	52	1
13012M-52-5	5	18	15.5	52	1
13012M-52-6	6	18	15.5	52	1
13012M-52-7	7	18	15.5	52	1
13012M-52-8	8	21	15.5	52	1
13012M-52-10	10	21	15.5	52	1
13012M-52-12	12	21	15.5	52	1
13012M-52-14	14	21	15.5	52	1



3/8" ESAGONO

BUSSOLE IMPACT BRUGOLA MM 4-5-6-7-8-10-12, LUNGH. 50 MM

attacco: 3/8"
impronta: ESAGONO MASCHIO

FEIMEC articolo	Descrizione	
511071	CASSETTA METALLICA 7 PEZZI	1

JAPAN



ESAGONO

CHIAVI A BUSSOLA A MACCHINA SNODATE MASCHIO ESAGONALE



Koken articolo	mm	D mm	l mm	L mm	
13430M-5	5	24	15	74	1
13430M-6	6	24	15	74	1
13430M-8	8	24	20	74	1
13430M-10	10	24	20	74	1
13430M-17	17	24	7	53	1

JAPAN



ESAGONO

SERIE 8 PZ. CHIAVI A BUSSOLA A MACCHINA MASCHIO ESAGONALE - INTEGRALI

Koken articolo	mm	
RS 13012M/8-L52	4, 5, 6, 7, 8, 10, 12, 14	1

POLLICI



3/8" ESAGONO

BUSSOLE IMPACT BRUGOLA MISURE IN POLLICI - 3/16"-7/32"-1/4"-9/32"-5/16"-3/8"-7/16" - LUNGH. 50 MM

attacco: 3/8"
impronta: ESAGONO MASCHIO

FEIMEC articolo	Descrizione	
411071	CASSETTA METALLICA 7 PEZZI	1

JAPAN



ESAGONO

CHIAVI A BUSSOLA A MACCHINA MASCHIO ESAGONALE TIPO EXTRA LUNGO SNODATA

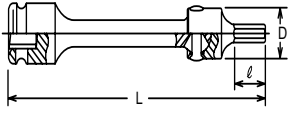

Koken articolo	mm	D mm	l mm	L mm	
13147M-150-4	4	21	15	150	1
13147M-150-5	5	21	15	150	1
13147M-150-6	6	21	15	150	1
13147M-150-8	8	21	15	150	1
13147M-150-10	10	21	15	150	1
13147M-200-4	4	21	15	200	1
13147M-200-5	5	21	15	200	1
13147M-200-6	6	21	15	200	1
13147M-200-8	8	21	15	200	1
13147M-200-10	10	21	15	200	1



TORX® IMPACT
 attacco: 3/8"
 impronta: TX

FEARMEC articolo	TORX	L mm	
184 - 3/8" - 10 GTX	TX 10	50	1
184 - 3/8" - 15 GTX	TX 15	50	1
184 - 3/8" - 20 GTX	TX 20	50	1
184 - 3/8" - 25 GTX	TX 25	50	1
184 - 3/8" - 27 GTX	TX 27	50	1
184 - 3/8" - 30 GTX	TX 30	50	1
184 - 3/8" - 40 GTX	TX 40	50	1
184 - 3/8" - 45 GTX	TX 45	50	1
184 - 3/8" - 50 GTX	TX 50	50	1



TORX®
 SERIE 8 PZ. CHIAVI A BUSSOLA A MACCHINA MASCHIO TORX®

Koken
 articolo
 RS 13025/8-L50 TX 4, 5, 6, 7, 8, 10, 12, 14 1

JAPAN



7/16" ESAGONO

INSERTO CON MASCHIO ESAGONALE

attacco: 7/16"
 impronta: ESAGONO



TORX®

CHIAVI A BUSSOLA A MACCHINA MASCHIO TORX®

JAPAN

Koken
 articolo D mm L mm

13025-50-T20	TX 20	19	50	1
13025-50-T25	TX 25	19	50	1
13025-50-T27	TX 27	19	50	1
13025-50-T30	TX 30	19	50	1
13025-50-T40	TX 40	19	50	1
13025-50-T45	TX 45	19	50	1
13025-50-T50	TX 50	19	50	1
13025-50-T55	TX 55	22	50	1
13025-90-T20	TX 20	19	90	1
13025-90-T25	TX 25	19	90	1
13025-90-T27	TX 27	19	90	1
13025-90-T30	TX 30	19	90	1
13025-90-T40	TX 40	19	90	1
13025-90-T45	TX 45	19	90	1
13025-90-T50	TX 50	19	90	1
13025-90-T55	TX 55	22	90	1

JAPAN



3/8 7/16" 11,11 mm

13134-SC

BUSSOLA PORTA INSERTI CON GRANO DI BLOCCAGGIO DA 7/16"

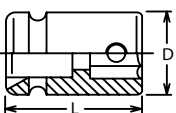

Koken
 articolo D mm L mm

13134	22	32	1
-------	----	----	---

RICAMBI

Koken
 articolo DESCRIZIONE

13134-SC GRANO DI RICAMBIO M8X5; ESAGONO 4 MM

Koken
 articolo mm L mm

183H-35-3	3	35	1
183H-35-4	4	35	1
183H-35-5	5	35	1
183H-35-6	6	35	1
183H-35-7	7	35	1
183H-35-8	8	35	1
183H-35-9	9	35	1
183H-35-10	10	35	1
183H-35-11	11	35	1
183H-35-12	12	35	1
183H-35-14	14	35	1
183H-35-16	16	35	1
183H-35-17	17	35	1
183H-35-18	18	35	1
183H-35-19	19	35	1
183H-75-3	3	75	1
183H-75-4	4	75	1
183H-75-5	5	75	1
183H-75-6	6	75	1
183H-75-7	7	75	1
183H-75-8	8	75	1
183H-75-10	10	75	1
183H-75-11	11	75	1
183H-75-12	12	75	1
183H-75-14	14	75	1
183H-150-4	4	150	1
183H-150-5	5	150	1
183H-150-6	6	150	1
183H-150-8	8	150	1
183H-150-10	10	150	1
183H-150-12	12	150	1

JAPAN



3/8 7/16" 11,11 mm

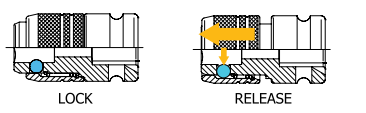

LOCK **RELEASE**

BUSSOLA PORTA INSERTI CON SGANCIO RAPIDO DA 7/16"

Koken
 articolo D mm L mm

13142-F11.2	22	46	1
-------------	----	----	---

TORX®

	S mm	S mm	
T 6	1.70	T 40	6.70
T 7	2.00	T 45	7.90
T 8	2.30	T 50	8.90
T 9	2.50	T 55	11.30
T 10	2.70	T 60	13.30
T 15	3.30	T 70	15.60
T 20	3.90	T 80	17.60
T 25	4.50	T 90	20.00
T 27	5.00	T 100	22.20
T 30	5.60		



JAPAN

7/16" **ESAGONO**

POLLICI

INSERTO CON MASCHIO ESAGONALE
attacco: 7/16"
impronta: ESAGONO

Koken articolo	POLLICI	L mm	
183H-35-3/16	3/16"	35	1
183H-35-7/32	7/32"	35	1
183H-35-1/4	1/4"	35	1
183H-35-5/16	5/16"	35	1
183H-35-3/8	3/8"	35	1
183H-35-7/16	7/16"	35	1
183H-35-1/2	1/2"	35	1

JAPAN

7/16" **ESAGONO**

novità

**INSERTO CON MASCHIO ESAGONALE
CON TESTA SFERICA**
attacco: 7/16"
impronta: ESAGONO CON TESTA SFERICA

Koken articolo	mm	L mm	
183H-75-6B	6	75	1
183H-75-8B	8	75	1
183H-75-10B	10	75	1
183H-75-12B	12	75	1
183H-150-6B	6	150	1
183H-150-8B	8	150	1
183H-150-10B	10	150	1
183H-150-12B	12	150	1

JAPAN

7/16" **TORX®**

INSERTO CON MASCHIO TORX®
attacco: 7/16"
impronta: TORX®

Koken articolo		L mm	
183T-35-T25	TX 25	35	1
183T-35-T30	TX 30	35	1
183T-35-T40	TX 40	35	1
183T-35-T45	TX 45	35	1
183T-35-T50	TX 50	35	1
183T-35-T55	TX 55	35	1
183T-35-T60	TX 60	35	1
183T-75-T25	TX 25	75	1
183T-75-T27	TX 27	75	1
183T-75-T30	TX 30	75	1
183T-75-T40	TX 40	75	1
183T-75-T45	TX 45	75	1
183T-75-T50	TX 50	75	1
183T-75-T55	TX 55	75	1
183T-75-T60	TX 60	75	1
183T-150-T30	TX 30	150	1
183T-150-T40	TX 40	150	1
183T-150-T45	TX 45	150	1
183T-150-T50	TX 50	150	1
183T-150-T55	TX 55	150	1
183T-150-T60	TX 60	150	1

JAPAN

3/8" **ESAGONO**

**BUSSOLA MASCHIO ESAGONALE
IN DUE PARTI:
BUSSOLA + INSERTO MASCHIO ESAGONALE**

Koken articolo	mm	L mm	
13134M-52-3	3	52	1
13134M-52-4	4	52	1
13134M-52-5	5	52	1
13134M-52-6	6	52	1
13134M-52-7	7	52	1
13134M-52-8	8	52	1
13134M-52-10	10	52	1
13134M-52-12	12	52	1
13134M-52-14	14	52	1
13134M-92-3	3	92	1
13134M-92-4	4	92	1
13134M-92-5	5	92	1
13134M-92-6	6	92	1
13134M-92-7	7	92	1
13134M-92-8	8	92	1
13134M-92-10	10	92	1
13134M-92-12	12	92	1
13134M-92-14	14	92	1

TORX®

	S mm	S mm	
T 6	1.70	T 40	6.70
T 7	2.00	T 45	7.90
T 8	2.30	T 50	8.90
T 9	2.50	T 55	11.30
T 10	2.70	T 60	13.30
T 15	3.30	T 70	15.60
T 20	3.90	T 80	17.60
T 25	4.50	T 90	20.00
T 27	5.00	T 100	22.20
T 30	5.60		

3/8



TORX®

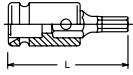

**BUSSOLA MASCHIO ESAGONALE
IN DUE PARTI:**

BUSSOLA + INSERTO MASCHIO TORX®

Koken articolo		L mm	
13134T-52-T25	TX 25	52	1
13134T-52-T30	TX 30	52	1
13134T-52-T40	TX 40	52	1
13134T-52-T45	TX 45	52	1
13134T-52-T50	TX 50	52	1
13134T-52-T55	TX 55	52	1
13134T-52-T60	TX 60	52	1
13134T-92-T30	TX 30	92	1
13134T-92-T40	TX 40	92	1
13134T-92-T45	TX 45	92	1
13134T-92-T50	TX 50	92	1
13134T-92-T55	TX 55	92	1
13134T-92-T60	TX 60	92	1

JAPAN

7/16"



TORXplus®

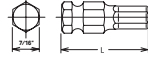

INSERTO CON MASCHIO TORX PLUS®

Koken articolo		L mm	
183T-35-30IP	30IP	35	1
183T-35-40IP	40IP	35	1
183T-35-45IP	45IP	35	1
183T-35-50IP	50IP	35	1
183T-35-55IP	55IP	35	1
183T-35-60IP	60IP	35	1
183T-75-30IP	30IP	75	1
183T-75-40IP	40IP	75	1
183T-75-45IP	45IP	75	1
183T-75-50IP	50IP	75	1
183T-75-55IP	55IP	75	1
183T-75-60IP	60IP	75	1

JAPAN

JAPAN

7/16"



XZN

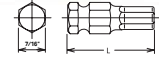

INSERTO CON MASCHIO XZN

attacco: 7/16"
impronta: XZN

Koken articolo		L mm	
183X-35-M 4	M 4	35	1
183X-35-M 5	M 5	35	1
183X-35-M 6	M 6	35	1
183X-35-M 8	M 8	35	1
183X-35-M 10	M10	35	1
183X-35-M 12	M12	35	1
183X-35-M 14	M14	35	1
183X-75-M 4	M 4	75	1
183X-75-M 5	M 5	75	1
183X-75-M 6	M 6	75	1
183X-75-M 8	M 8	75	1
183X-75-M 10	M10	75	1
183X-75-M 12	M12	75	1
183X-75-M 14	M14	75	1
183X-150-M 5	M 5	150	1
183X-150-M 6	M 6	150	1
183X-150-M 8	M 8	150	1
183X-150-M 10	M10	150	1
183X-150-M 12	M12	150	1
183X-150-M 14	M14	150	1

3/8



TORXplus®

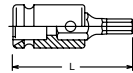

**BUSSOLA MASCHIO ESAGONALE
IN DUE PARTI:
BUSSOLA + INSERTO MASCHIO TORX PLUS®**

Koken articolo		L mm	
13134T-52-30IP	30IP	52	1
13134T-52-40IP	40IP	52	1
13134T-52-45IP	45IP	52	1
13134T-52-50IP	50IP	52	1
13134T-52-55IP	55IP	52	1
13134T-52-60IP	60IP	52	1
13134T-92-30IP	30IP	92	1
13134T-92-40IP	40IP	92	1
13134T-92-45IP	45IP	92	1
13134T-92-50IP	50IP	92	1
13134T-92-55IP	55IP	92	1
13134T-92-60IP	60IP	92	1

JAPAN

3/8



XZN

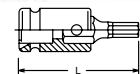

**BUSSOLA MASCHIO ESAGONALE
IN DUE PARTI:
BUSSOLA + INSERTO MASCHIO XZN**

Koken articolo		L mm	
13134X-52-M5	M 5	52	1
13134X-52-M6	M 6	52	1
13134X-52-M8	M 8	52	1
13134X-52-M10	M10	52	1
13134X-52-M12	M12	52	1
13134X-52-M14	M14	52	1
13134X-92-M5	M 5	92	1
13134X-92-M6	M 6	92	1
13134X-92-M8	M 8	92	1
13134X-92-M10	M10	92	1
13134X-92-M12	M12	92	1
13134X-92-M14	M14	92	1

JAPAN

TORXplus®

	S mm	S mm
8 IP	2.30	30 IP 5.60
9 IP	2.50	40 IP 6.70
10 IP	2.70	45 IP 7.90
15 IP	3.30	50 IP 8.90
20 IP	3.90	55 IP 11.30
25 IP	4.50	60 IP 13.30
27 IP	5.00	

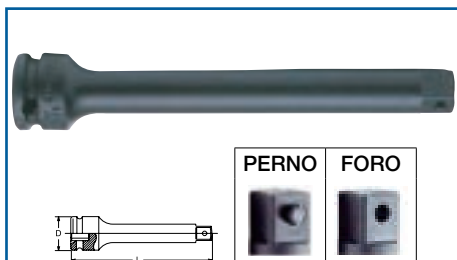

PERNO **FORO**

PROLUNGA

Koken articolo	D mm	PERNO	L mm	
13760-50P	22	PERNO	50	1
13760-75P	22	PERNO	75	1
13760-100P	22	PERNO	100	1
13760-125P	22	PERNO	125	1
13760-150P	22	PERNO	150	1
13760-200P	22	PERNO	200	1
13760-250P	22	PERNO	250	1
13760-50	22	FORO	50	1
13760-75	22	FORO	75	1
13760-100	22	FORO	100	1
13760-125	22	FORO	125	1
13760-150	22	FORO	150	1
13760-200	22	FORO	200	1
13760-250	22	FORO	250	1

JAPAN



PERNO

CON RIVESTIMENTO ANTI-GRAFFIO
PROLUNGA CON RIVESTIMENTO

Koken articolo	D mm	L mm	
13760-75P.FR	26.2	75	1
13760-125P.FR	26.2	125	1
13760-250P.FR	26.2	250	1



SFERA

3/8" **PRO+** **CRO MO** **3/8"**

BGS articolo	DESCRIZIONE
BGS 189	SNODO A MACCHINA

CARATTERISTICHE

- finitura nera
- con sfera di tenuta
- peso: 100 g

novità



PRO+ **1/2"**

BGS articolo	DESCRIZIONE
BGS 25145	SET 9 PEZZI, PROLUNGHE IMPACT, 1/4" - 3/8" - 1/2"

CARATTERISTICHE

- per uso a mano e a macchina
- con scanalatura e foro per spina
- in cassetta in plastica
- materiale: acciaio al cromo molibdeno
- attacco quadro
- finitura: nero brunito
- comprende:
 - prolunghe impact, att. 1/4": 50 mm - 100 mm - 150 mm
 - prolunghe impact, att. 3/8": 50 mm - 75 mm - 150 mm
 - prolunghe impact, att. 1/2": 50 mm - 125 mm (BGS 193) - 250 mm (BGS 194)
- peso 1,6 kg



1/4" **3/8"** **1/2"** **PRO+** **CRO MO**

BGS articolo	DESCRIZIONE
BGS 9459	SET 3 PEZZI, SNODI

CARATTERISTICHE

- con scanalatura e foro per spina
- comprende:
 - snodo 1/4" F - 1/4" M
 - snodo 3/8" F - 3/8" M
 - snodo 1/2" F - 1/2" M
- peso: 420 g



PERNO **SFERA**

3/8" **3/8"**

PROLUNGHE PER BUSSOLE "POWER IMPACT" MASCHIO/FEMMINA

FERMEC articolo	PERNO	L mm	
97-3	PERNO	75	1
97-3-100	PERNO	100	1
97-3-125	PERNO	125	1
97-4	PERNO	150	1
97-4-200	PERNO	200	1
97-5-250	PERNO	250	1
97-5-300	PERNO	300	1
97-3-125 SWF	SGANCIO RAPIDO	125	1
97-3 S	SFERA	75	1
97-3-100 S	SFERA	100	1
97-3-125 S	SFERA	125	1
97-4 S	SFERA	150	1
97-4-200 S	SFERA	200	1
97-5-250 S	SFERA	250	1

JAPAN



PERNO **SFERA** **FORO**

SNODO UNIVERSALE

Koken articolo	PERNO	L mm	
13771-P	PERNO	48	1
13771-B novità	SFERA	48	1
13771	FORO	48	1

IMPACT 3/8"

NOTE



JAPAN

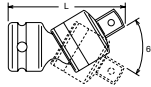

SNODO UNIVERSALE

Koken		L mm	Box
articolo			
13770-P	PERNO	56	1
13770-B <i>novità</i>	SFERA	56	1
13770	FORO	56	1

ADATTATORI DOPPIO QUADRO MASCHIO

FEARMEC articolo		L mm
2841	1/4"	20
3841	3/8"	30
4841	1/2"	37
BGS 9623	3/4"	53
8841	1"	68

CARATTERISTICHE

- con doppia sfera



JAPAN

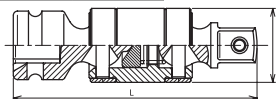

DOPPIO SNODO

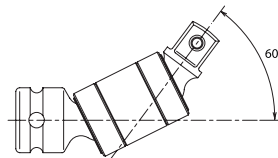

Koken		D mm	L mm	Box
articolo				
13772-P	PERNO	22	75	1
13772-B <i>novità</i>	SFERA	22	75	1

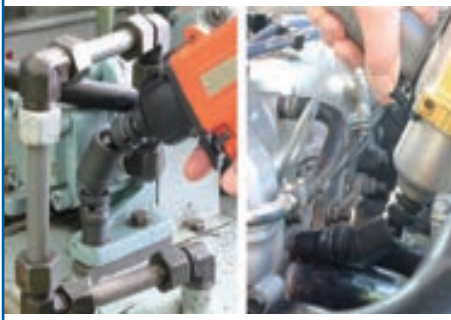

PROLUNGHE PER BUSSOLE "POWER IMPACT" MASCHIO/MASCHIO

FEARMEC articolo	B	A	L mm	Box
Z 0802	1/2"	1/2"	50	1
Z 0803	1/2"	1/2"	76	1
Z 0805	1/2"	1/2"	127	1
Z 0810	1/2"	1/2"	254	1
Z 1203	3/4"	3/4"	78	1
Z 1204	3/4"	3/4"	101	1
Z 1205	3/4"	3/4"	127	1
Z 1207	3/4"	3/4"	177	1
Z 1603	1"	1"	76	1
Z 1604	1"	1"	101	1
Z 1605	1"	1"	127	1
Z 1606	1"	1"	152	1
Z 1616	1"	1"	406	1
Z 2404	1 1/2"	1 1/2"	101	1
Z 2405	1 1/2"	1 1/2"	127	1
Z 4005	2-1/2"	2-1/2"	127	1



RIDUZIONI PER BUSSOLE "POWER IMPACT" FEMMINA/FEMMINA

FEARMEC articolo	B	A	L mm	Box
AN 0808	1/2"	1/2"	33	1
AN 1208	3/4"	1/2"	49	1
AN 1212	3/4"	3/4"	49	1
AN 1612	1"	3/4"	63	1
AN 1616	1"	1"	59	1
AN 2416	1-1/2"	1"	83	1
AN 2424	1 1/2"	1-1/2"	85	1



RACCORDI DI RIDUZIONE "POWER IMPACT" MASCHIO/FEMMINA

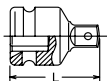

articolo		F	M	L mm	
12233 A-P	PERNO	1/4"	3/8"	22	1
12233 A-B	SFERA	1/4"	3/8"	22	1
12233 A	FORO	1/4"	3/8"	22	1
13322 A-P	PERNO	3/8"	1/4"	27	1
13322 A-B	SFERA	3/8"	1/4"	27	1
13322 A	FORO	3/8"	1/4"	27	1
13344 A-P	PERNO	3/8"	1/2"	32.5	1
13344 A-B	SFERA	3/8"	1/2"	32.5	1
13344 A	FORO	3/8"	1/2"	32.5	1
14433 A-P	PERNO	1/2"	3/8"	37.5	1
14433 A-B	SFERA	1/2"	3/8"	37.5	1
14433 A	FORO	1/2"	3/8"	37.5	1
14455 A	FORO	1/2"	5/8"	42	1
14466 A	FORO	1/2"	3/4"	44	1
14466 A-B	SFERA	1/2"	3/4"	44	1
14466 A-200 B	SFERA	1/2"	3/4"	200	1
14488 A-B	SFERA	1/2"	1"	58	1
14488 A-200 B	SFERA	1/2"	1"	200	1
15544 A-P	PERNO	5/8"	1/2"	46	1
15544 A	FORO	5/8"	1/2"	46	1
15566 A	FORO	5/8"	3/4"	48	1
16644 A-B	PERNO	3/4"	1/2"	54	1
16644 A-P	SFERA	3/4"	1/2"	54	1
16644 A	FORO	3/4"	1/2"	54	1
16655 A	FORO	3/4"	5/8"	55.5	1
16688 A	FORO	3/4"	1"	62	1
16688 A-250	FORO	3/4"	1"	250	1
16688 A-330	FORO	3/4"	1"	330	1
18866 A	FORO	1"	3/4"	66.5	1
18866 A-200	FORO	1"	3/4"	200	1
18877 A	FORO	1"	1-1/2"	80	1
17788 A	FORO	1-1/2"	1"	98	1
17799 A	FORO	1-1/2"	2-1/2"	115	1
19977 A	FORO	2-1/2"	1-1/2"	145	1
10099 A	FORO	3-1/2"	2-1/2"	182	1



RACCORDI DI RIDUZIONE "POWER IMPACT" MASCHIO/FEMMINA

articolo	F	M	L mm	
96-00	PERNO 1/4"	3/8"	32	1
96-0	PERNO 3/8"	1/4"	35	1
96-1	PERNO 3/8"	1/2"	45	1
96-01	PERNO 1/2"	1/4"	38	1
96-2	PERNO 1/2"	3/8"	45	1
96-3	FORO 5/8"	1/2"	50	1
96-4	PERNO 3/4"	1/2"	56	1
96-8	FORO 3/4"	1"	70	1
96-9	FORO 1"	3/4"	70	1
96-10	PERNO 1"	1/2"	70	1
96-11	FORO 1/2"	3/4"	50	1
96-12	FORO 1 1/2"	1"	115	1
96-13	FORO 1"	1 1/2"	115	1
96-14	FORO 2 1/2"	1 1/2"	115	1
96-15	FORO 1 1/2"	2 1/2"	120	1
96-16	FORO 1 1/4"	1"	140	1
96-17	FORO 1 3/4"	1 1/2"	150	1



RACCORDI DI RIDUZIONE "POWER IMPACT" MASCHIO/FEMMINA CON SFERA DI TENUTA NEL QUADRO MASCHIO

articolo	F	M	L mm	
696-00 S	1/4"	3/8"	26	1
696-0 S	3/8"	1/4"	32	1
696-01 S	1/2"	1/4"	36	1
696-1 S	3/8"	1/2"	36	1
696-2 S	1/2"	3/8"	38	1
696-11 S	1/2"	3/4"	48	1
696-4 S	3/4"	1/2"	56	1
696-8 S	3/4"	1"	63	1
696-9 S	1"	3/4"	75	1

ARTICOLO NON SOGGETTO A GARANZIA



articolo	DESCRIZIONE
BGS 200	SET 6 PEZZI, RIDUZIONI A MACCHINA
CARATTERISTICHE	
<ul style="list-style-type: none"> • rivestimento specifico nero opaco • peso: 880 g 	
CONTENUTO	
<ul style="list-style-type: none"> • 1/4" F X 3/8" M, coppia massima 60 Nm • 3/8" F X 1/4" M, coppia massima 60 Nm • 3/8" F X 1/2" M, coppia massima 200 Nm • 1/2" F X 3/8" M, coppia massima 200 Nm • 1/2" F X 3/4" M, coppia massima 500 Nm • 3/4" F X 1/2" M, coppia massima 500 Nm 	
RICAMBI	
articolo	DESCRIZIONE
BGS 200-LEER	CASSETTA VUOTA



articolo	DESCRIZIONE
BGS 25140	SET 11 PEZZI, RIDUZIONI E SNODI A MACCHINA
CARATTERISTICHE	
<ul style="list-style-type: none"> • rivestimento specifico nero opaco • peso: 2,6 kg 	
CONTENUTO	
<ul style="list-style-type: none"> • 1/4" F x 3/8" M • 3/8" F x 1/4" M • 3/8" F x 1/2" M • 1/2" F x 3/8" M • 1/2" F x 3/4" M • 3/4" F x 1/2" M • 3/4" F x 1" M • 1" F x 3/4" M • snodi da 1/4", 3/8", 1/2" 	



1/4"-3/8"-1/2"-3/4" 1/4"-3/8"-1/2"-3/4"

RACCORDI DI RIDUZIONE CHROM-VANADIUM

attacco: 1/4" - 3/8" - 1/2" - 3/4"

BGS articolo	FEMMINA	MASCHIO	
BGS 271	1/4"	3/8"	1
BGS 269	3/8"	1/4"	1
BGS 280	3/8"	1/2"	1
BGS 270	1/2"	3/8"	1
BGS 272	1/2"	3/4"	1
BGS 274	3/4"	1/2"	1



RACCORDO DI RIDUZIONE MASCHIO/FEMMINA CON SFERA DI TENUTA NEL QUADRO MASCHIO



Koken articolo	F	M	L mm	
2233 A	1/4"	3/8"	22	1
3322 A	3/8"	1/4"	24	1
3344 A	3/8"	1/2"	35	1
4433 A-35	1/2"	3/8"	35	1
4433 A-75	1/2"	3/8"	75	1
4433 A-125	1/2"	3/8"	125	1
4433 A-250	1/2"	3/8"	250	1
4433 A-600	1/2"	3/8"	600	1
4466 A	1/2"	3/4"	42	1
6644 A	3/4"	1/2"	47	1
6688 A	3/4"	1"	60	1
8866 A	1"	3/4"	60	1



RACCORDI DI RIDUZIONE A MANDRINO CON SGANCIO RAPIDO "POWER IMPACT"

FEFMEC articolo	F	M	L mm	
691-0 SWF	3/8"	1/4"	55	1
691-1 SWF	3/8"	1/2"	60	1
691-2 SWF	1/2"	3/8"	55	1
691-11 SWF	1/2"	3/4"	75	1
691-4 SWF	3/4"	1/2"	70	1
691-9 SWF	1"	3/4"	90	1

Koken articolo	F	M	L mm	
14466 AL	1/2"	3/4"	75	1
16644 AL	3/4"	1/2"	70	1



RACCORDI DI RIDUZIONE MAGNETICI A SCOMPARSA IDEALI PER CHIAVI DINAMOMETRICHE E SPAZI RIDOTTI

attacco: 1/4"-3/8"-1/2"

FEFMEC articolo	F	M	
1434-1/4	1/4"	3/8"	1
1434-3/8	3/8"	1/2"	1
1434-1/2	1/2"	3/4"	1



RIDUZIONI A SCOMPARSA CON SFERA NEL QUADRO MASCHIO

Koken articolo	F	M	D mm	L mm	
2756 Z-3/8	1/4"	3/8"	20.3	21.5	1
2756 Z-1/2	1/4"	1/2"	20.3	26	1
3756 Z-1/2	3/8"	1/2"	28	29	1

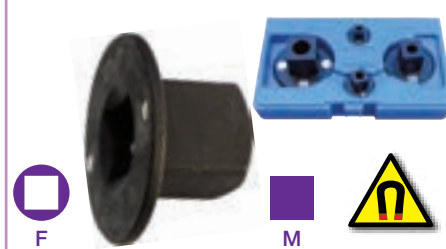

RACCORDI DI RIDUZIONE MAGNETICI "POWER IMPACT"

A SCOMPARSA - SPAZI RIDOTTI

FEFMEC articolo	F	M	L mm	
698-00	1/4"	3/8"	17	1
698-0	1/4"	1/2"	22	1
698-1	3/8"	1/2"	22	1
698-11	1/2"	3/4"	30	1
698-8	3/4"	1"	35	1
698-13	1"	1 1/2"	50	1
698-15	1 1/2"	2 1/2"	60	1

698	CASSETTA 4 PZ. CONTENUTO:	
	1 PZ. 698-00	
	1 PZ. 698-1	
	1 PZ. 698-11	
	1 PZ. 698-8	1

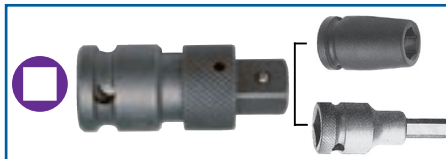

MANDRINO CON SGANCIO RAPIDO PER BUSSOLE "POWER IMPACT"

attacco: Quadro femmina
impronta: DIN 3126, E 11,2 - E 6,35

FEFMEC articolo	F	M	L mm	
195-SWF	1/4"	1/4"	41	1
196-SWF	3/8"	3/8"	46	1
97-3-125 SWF	3/8"	3/8"	125	1
197-SWF	1/2"	1/2"	60	1
199-SWF	3/4"	3/4"	78	1
1991-SWF	1"	1"	100	1

Koken articolo	F	M	L mm	
12222 AL	1/4"	1/4"	35	1
13333 AL	3/8"	3/8"	45	1
14444 AL	1/2"	1/2"	55	1
16666 AL	3/4"	3/4"	75	1
18888 AL	1"	1"	95	1

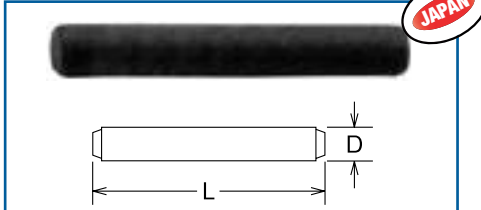

JAPAN

SPINE ACCIAIO PER BUSSOLE

Koken articolo	Ø	D mm	L mm	Box
A 21	1/4"	1.5	10,2	1
A 31	3/8"	2.5	14,5	1
A 32	3/8"	2.5	17,5	1
A 41	1/2"	3.0	20	1
A 42	1/2"	3.0	25	1
A 51	5/8"	4.0	29	1
A 61	3/4"	4.0	35	1
A 62	3/4"	4.0	45	1
A 81	1"	5.0	45	1
A 82	1"	5.0	57	1
A 83	1"	5.0	75	1
A 71	1 1/2"	6.0	75	1
A 72	1 1/2"	6.0	110	1
A 91	2 1/2"	8.0	110	1
A 92	2 1/2"	8.0	155	1
A 01	3 1/2"	13.0	155	1
A 02	3 1/2"	13.0	180	1

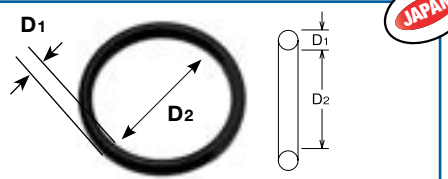

JAPAN

ANELLI DI GOMMA PER BUSSOLE

Koken articolo	Ø	D 1 mm	D 2 mm	Box
B 21	1/4"	2.5	9	1
B 31	3/8"	3.5	13	1
B 32	3/8"	3.5	16	1
B 41	1/2"	4	19	1
B 42	1/2"	4	24	1
B 51	5/8"	5	28	1
B 61	3/4"	5	36	1
B 62	3/4"	5	45	1
B 81	1"	7	45	1
B 82	1"	7	57	1
B 83	1"	7	75	1
B 71	1 1/2"	10	75	1
B 72	1 1/2"	10	114	1
B 91	2 1/2"	10.5	114	1
B 92	2 1/2"	10.5	158	1
B 01	3 1/2"	15	158	1
B 02	3 1/2"	15	183	1

NOTE

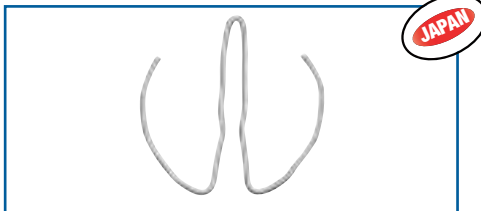

JAPAN

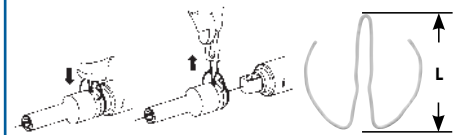

MOLLA DI SICUREZZA PER BUSSOLE

Koken articolo	Ø	Ø	L mm	Box
C 31	3/8"	≤ 12	18	1
C 32	3/8"	> 12	20	1
C 41	1/2"	≤ 14	23	1
C 42	1/2"	> 14	26	1
C 61	3/4"	≤ 46	41	1
C 81	1"	≤ 46	50	1
C 82	1"	> 46	50	1
C 83	1"	> 70	50	1
C 71	1 1/2"	≤ 90	50	1



JAPAN

ESTRATTORE PER MOLLE DI SICUREZZA

Koken articolo	Ø	Box
149	3/8" - 1/2"	1
152	3/4" - 1"	1

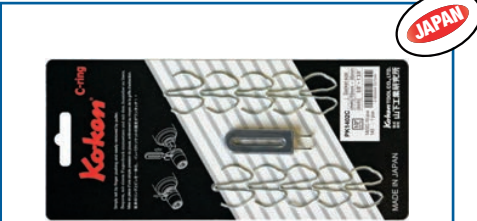

JAPAN

SET MOLLE DI SICUREZZA PER BUSSOLE

Koken articolo	nr.	nr.	Box
PKC 31	10	149	1
PKC 32	10	149	1
PKC 41	10	149	1
PKC 42	10	149	1
PKC 61	10	152	1
PKC 81	10	152	1

MOLLE-SPINE-ANELLI



CHIAVI A BUSSOLA
GUIDATE ANTI VIBRAZIONI
BOCCA ESAGONALE

Koken articolo	mm	D mm	L mm	
NV 13400M-8	8	13.3	43	1
NV 13400M-10	10	15.8	43	1
NV 13400M-11	11	17	43	1
NV 13400M-12	12	18.3	43	1
NV 13400M-13	13	19.5	43	1
NV 13400M-14	14	20.8	43	1
NV 13400M-15	15	22	43	1
NV 13400M-16	16	23.3	43	1
NV 13400M-17	17	24.5	43	1
NV 13400M-18	18	25.8	43	1
NV 13400M-19	19	27	43	1
NV 13400M-21	21	29.5	43	1
NV 13400M-22	22	30.8	43	1



CHIAVI A BUSSOLA
GUIDATE ANTI
VIBRAZIONI
BOCCA ESAGONALE
EXTRA LUNGHE

Koken articolo	mm	D mm	L mm	
NV 13145M-100-6	6	13	100	1
NV 13145M-100-8	8	13	100	1
NV 13145M-100-10	10	15.5	100	1
NV 13145M-100-12	12	18	100	1
NV 13145M-100-13	13	19	100	1
NV 13145M-100-14	14	21	100	1
NV 13145M-100-15	15	22	100	1
NV 13145M-100-16	16	24	100	1
NV 13145M-100-17	17	25	100	1
NV 13145M-150-6	6	13	150	1
NV 13145M-150-8	8	13	150	1
NV 13145M-150-10	10	15.5	150	1
NV 13145M-150-12	12	18	150	1
NV 13145M-150-13	13	19	150	1
NV 13145M-150-14	14	21	150	1
NV 13145M-150-15	15	22	150	1
NV 13145M-150-16	16	24	150	1
NV 13145M-150-17	17	25	150	1
NV 13145M-200-6	6	13	200	1
NV 13145M-200-8	8	13	200	1
NV 13145M-200-10	10	15.5	200	1
NV 13145M-200-12	12	18	200	1
NV 13145M-200-13	13	19	200	1
NV 13145M-200-14	14	21	200	1
NV 13145M-200-15	15	22	200	1
NV 13145M-200-16	16	24	200	1
NV 13145M-200-17	17	25	200	1



PROLUNGA ANTI VIBRAZIONI

Koken articolo	D mm	L mm	
NV 13760-75P	19	75	1
NV 13760-125P	19	125	1
NV 13760-150P	19	150	1
NV 13760-250P	19	250	1



ELIMINAZIONE DELLE VIBRAZIONI
LA PROLUNGA DEL MANDRINO CALZA
SULLA PARETE CILINDRICA DELL' ALBERO
DELL' AVVITATORE
ATTENZIONE: CONTROLLARE LA
LUNGHEZZA DELL' ALBERO!

articolo	3/8"	1/4" E	L mm	
NV 3814	3/8"	1/4" E	52	1
NV 38716	3/8"	7/16"	55	1



BUSSOLA
PORTAINSERTI
ANTI
VIBRAZIONI
DA 7/16"

Koken articolo	D mm	L mm	
NV 13134	22	45	1



MANDRINI ANTIVIBRAZIONE PORTABUSSOLE
E SGANCIO RAPIDO

articolo	3/8"	3/8"	L mm	
NV 196	3/8"	3/8"	75	1

Guidate
antivibrazioni

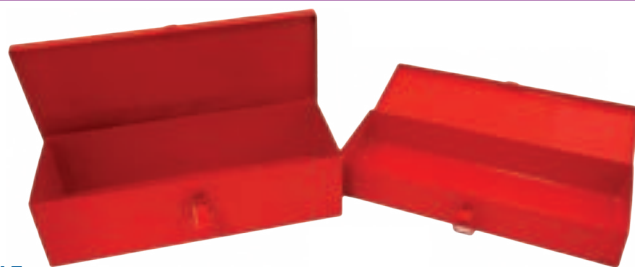

CASSETTE METALLICHE PORTA-BUSSOLE

FEARMEC articolo	lunghezza (mm)	larghezza (mm)	altezza (mm)	
CASS-2510	240	100	60	1
CASS-2810	280	130	75	1
CASS-3009	300	90	45	1
CASS-3112	310	120	80	1
CASS-3211	320	120	50	1
CASS-4220	420	200	140	1
CASS-6213	610	130	80	1

NOTE

- a richiesta assortimenti di bussole a macchina in cassetta metallica



PRO+

GUIDE PORTA BUSSOLE CON CLIP

BGS articolo		Numero Clip
BGS 2316	1/4"	7
BGS 2317	3/8"	7
BGS 2318	1/2"	7
BGS 2120	1/4"	15
BGS 2330	3/8"	15
BGS 2540	1/2"	15
BGS 3460	3/4"	12

CARATTERISTICHE

- cromato satinato



GUIDE PORTA BUSSOLE PER MOLLE IN ACCIAIO DA 1/4" - 3/8" - 1/2" - 3/4"

Kokon articolo	L mm	
R 158	158	1
R 251	251	1
R 300	300	1
R 400	400	1



MOLLE IN ACCIAIO PER GUIDE

Kokon articolo		
C 14	1/4"	1
C 38	3/8"	1
C 12	1/2"	1
C 34	3/4"	1

BGS 74549



BGS 74550



BGS 74551



GUIDE MAGNETICHE PORTABUSSOLE, CON CLIP

BGS articolo	DESCRIZIONE	PESO GR.
BGS 74549	1/4"	260 GR.
BGS 74550	3/8"	270 GR.
BGS 74551	1/2"	300 GR.

CARATTERISTICHE

- adatto per bussole attacco:
 - BGS 74549: 1/4"
 - BGS 74550: 3/8"
 - BGS 74551: 1/2"
- con 12 clip
- con supporto in plastica
- base del supporto magnetica: garantisce la tenuta su tutte le superfici ferrose, su carrelli da officina, combinazioni di sistemi di stoccaggio, macchine, piattaforme di sollevamento e cassette in metallo
- base con fori a ciascuna estremità per l'installazione a parete
- materiale: alluminio / plastica
- dimensioni (larghezza - altezza - lunghezza):
 - BGS 74549, attacco 1/4": 28 x 20 x 420 mm
 - BGS 74550, attacco 3/8": 28 x 22 x 420 mm
 - BGS 74551, attacco 1/2": 28 x 25 x 420 mm





JAPAN



GUIDE MAGNETICHE PORTA BUSSOLE CON CLIP IDEALI PER USO SU PONTI SOLLEVATORI



Kokon articolo		Nr. Clip	L mm	
RSAL 200-1/4X12	1/4"	12	200	1
RSAL 200-3/8X8	3/8"	8	200	1
RSAL 300-3/8X12	3/8"	12	300	1
RSAL 300-1/2X10	1/2"	10	300	1



JAPAN

**GUIDE PORTA BUSSOLE
MAGNETICHE PER MOLLE
IN PLASTICA**





Kokon articolo	L mm	
RSAL-200	200	1
RSAL-300	300	1



JAPAN

MOLLE IN PLASTICA PER GUIDE

Kokon articolo		
CLIP-1/4	1/4"	1
CLIP-3/8	3/8"	1
CLIP-1/2	1/2"	1

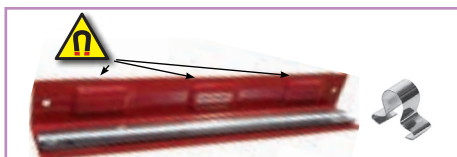

**GUIDA MAGNETICA PER MOLLE PORTA
BUSSOLE DA 1/4" - 3/8" - 1/2" - 3/4"**

FERMEC articolo	L mm	
MAG 300	300	1

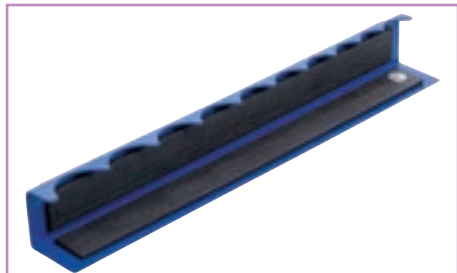

BARRA PORTABUSSOLE MAGNETICA,

BGS articolo		Numero vani
BGS 3011-1	1/4"	10
BGS 3011-2	3/8"	12
BGS 3011-3	1/2"	10

CARATTERISTICHE

- le bussole sono trattenute grazie ad una banda magnetica

BGS HANGER-1



BGS HANGER-2



BGS HANGER-3



BGS HANGER-4



BGS HANGER-5



CLIP X ATTACCO QUADRO FEMMINA

BGS articolo	
BGS HANGER-1	1/4"
BGS HANGER-2	3/8"
BGS HANGER-3	1/2"
BGS HANGER-4	3/4"
BGS HANGER-5	1"

CARATTERISTICHE

- clip in plastica con quadro maschio
- ad esempio per esposizione bussole

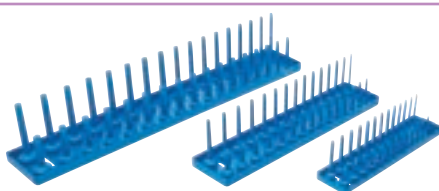

BGS articolo	DESCRIZIONE
BGS 67158	SET 3 PEZZI PORTA-BUSSOLE

CARATTERISTICHE

- con occhiello per appenderle o per il montaggio a parete
- adatto per bussole corte e lunghe
- materiale: plastica
- comprende:
 - 1 supporto per 28 bussole attacco 1/4"
 - 1 supporto per 30 bussole attacco 3/8"
 - 1 supporto per 34 bussole attacco 1/2"
- peso: 70 g

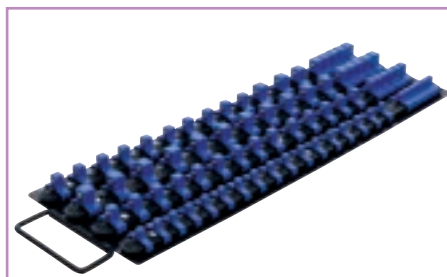

BGS articolo	DESCRIZIONE
BGS 6871	SET GUIDE PER BUSSOLE, CON 80 CLIP, PER BUSSOLE 1/4", 3/8" E 1/2"

CARATTERISTICHE

- ideale per lo stoccaggio delle bussole
- comprende:
 - 26 clip con sfera: 1/4"
 - 30 clip con sfera: 3/8"
 - 24 clip con sfera: 1/2"
 - 4 guide
 - piastra di fissaggio
- peso: 1,0 kg

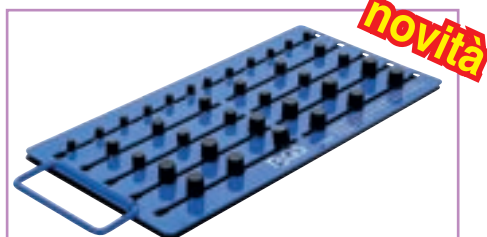

BGS articolo	DESCRIZIONE
BGS 74484	PIASTRA MAGNETICA, CON IMPUGNATURA, PER 36 BUSSOLE ATTACCO 1/4", 3/8" E 1/2"

CARATTERISTICHE

- pratico supporto per bussole
- 12 clip magnetiche rotondi per ogni misura
- le clip magnetiche garantiscono una tenuta sicura la facilità di rimozione
- potente superficie magnetica della piastra
- per il fissaggio temporaneo a superfici metalliche, scaffali o carrelli da officina
- con impugnatura in metallo per appendere o trasportare
- portata massima: 5 kg
- larghezza: 155 mm
- altezza: 6 mm
- lunghezza: 335 mm
- peso: 1,4 kg



Koken articolo	mm	D ₁ mm	L mm	
4401M-8	8	13.2	36	1
4401M-9	9	13.8	37	1
4401M-10	10	15.3	37	1
4401M-11	11	16.5	37	1
4401M-12	12	17.8	37	1
4401M-13	13	19	37	1
4401M-14	14	20.3	37	1
4401M-15	15	21.5	37	1
4401M-16	16	22.8	37	1
4401M-17	17	24	37	1
4401M-18	18	25	37	1
4401M-19	19	26.5	38	1
4401M-20	20	27.8	38	1
4401M-21	21	29	38	1
4401M-22	22	30	40	1
4401M-23	23	31.5	40	1
4401M-24	24	32.8	42	1
4401M-25	25	34	42	1
4401M-26	26	35	42	1
4401M-27	27	36.5	43	1
4401M-28	28	37.8	43	1
4401M-29	29	39	43	1
4401M-30	30	40	46	1
4401M-31	31	41.5	46	1
4401M-32	32	42.8	46	1
4400M-33	33	44.2	47	1
4400M-34	34	45.2	47	1
4400M-35	35	46.2	47	1
4400M-36	36	47.2	47	1
4400M-37	37	48.3	47	1
4400M-38	38	49.2	47	1
4400M-41	41	53.1	47	1
4400M-46	46	59.1	47	1



Koken articolo	mm	D ₁ mm	L mm	
4406M-8	8	13.2	36	1
4406M-9	9	13.8	37	1
4406M-10	10	15.3	37	1
4406M-11	11	16.5	37	1
4406M-12	12	17.8	37	1
4406M-13	13	19	37	1
4406M-14	14	20.3	37	1
4406M-15	15	21.5	37	1
4406M-16	16	22.8	37	1
4406M-17	17	24	37	1
4406M-18	18	25	37	1
4406M-19	19	26.5	38	1
4406M-20	20	27.8	38	1
4406M-21	21	29	38	1
4406M-22	22	30	40	1
4406M-23	23	31.5	40	1
4406M-24	24	32.8	42	1
4406M-25	25	34	42	1
4406M-26	26	35	42	1
4406M-27	27	36.5	43	1
4406M-28	28	37.8	43	1
4406M-29	29	39	43	1
4406M-30	30	40	46	1
4406M-31	31	41.5	46	1
4406M-32	32	42.8	46	1
4405M-33	33	44.2	47	1
4405M-34	34	45.2	47	1
4405M-35	35	46.2	47	1
4405M-36	36	47.2	47	1
4405M-37	37	48.3	47	1
4405M-38	38	49.2	47	1
4405M-41	41	53.1	47	1
4405M-46	46	59.1	47	1



Koken articolo	pollici	D ₁ mm	L mm	
4400A-1/4	1/4"	10.7	36	1
4400A-5/16	5/16"	13.2	36	1
4400A-3/8	3/8"	14.6	37	1
4400A-7/16	7/16"	16.5	37	1
4400A-1/2	1/2"	19	37	1
4400A-9/16	9/16"	20.3	37	1
4400A-19/32	19/32"	21.5	37	1
4400A-5/8	5/8"	22.8	37	1
4400A-21/32	21/32"	24	37	1
4400A-11/16	11/16"	25	37	1
4400A-3/4	3/4"	26.5	38	1
4400A-25/32	25/32"	27.8	38	1
4400A-13/16	13/16"	29	38	1
4400A-7/8	7/8"	30	40	1
4400A-15/16	15/16"	32.8	42	1
4400A-31/32	31/32"	34	42	1
4400A-1	1"	35	42	1
4400A-1-1/16	1-1/16"	36.5	43	1
4400A-1-1/8	1-1/8"	39	43	1
4400A-1-3/16	1-3/16"	40	46	1
4400A-1-1/4	1-1/4"	42.8	46	1
4400A-1-5/16	1-5/16"	44.2	47	1
4400A-1-3/8	1-3/8"	46.2	47	1
4400A-1-7/16	1-7/16"	47.2	47	1
4400A-1-1/2	1-1/2"	49.2	47	1



FENEC
articolo

DESCRIZIONE

FM 31032

SET 6 PEZZI, INSERTI ANTI-GRAFFIO PER CHIAVI A BUSSOLA ESAGONALI

CARATTERISTICHE

- inserti speciali che, utilizzati all'interno delle bussole esagonali tradizionali, consentono di prevenire danni a parti cromate o verniciate o, più in generale, con trattamenti superficiali
- comprende:
 - inserto 8 mm, per bussola 12 mm, coppia 9 Nm
 - inserto 10 mm, per bussola 14 mm, coppia 17 Nm
 - inserto 12 mm, per bussola 16 mm, coppia 27 Nm
 - inserto 13 mm, per bussola 17 mm, coppia 45 Nm
 - inserto 15 mm, per bussola 19 mm, coppia 50 Nm
 - inserto 17 mm, per bussola 22 mm, coppia 79 Nm
- per uso con bussole esagonali metriche





POLLICI

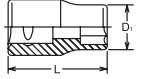

POLIGONALE

CHIAVI A BUSSOLA A MANO BOCCA POLIGONALE





Koken articolo	 pollici	D ₁ mm	L mm	
4405A-1/4	1/4"	13.2	36	1
4405A-5/16	5/16"	13.2	36	1
4405A-3/8	3/8"	14.6	37	1
4405A-7/16	7/16"	16.5	37	1
4405A-1/2	1/2"	19	37	1
4405A-9/16	9/16"	20.3	37	1
4405A-19/32	19/32"	21.5	37	1
4405A-5/8	5/8"	22.8	37	1
4405A-21/32	21/32"	24	37	1
4405A-11/16	11/16"	25	37	1
4405A-3/4	3/4"	26.5	38	1
4405A-25/32	25/32"	27.8	38	1
4405A-13/16	13/16"	29	38	1
4405A-7/8	7/8"	30	40	1
4405A-15/16	15/16"	32.8	42	1
4405A-31/32	31/32"	34	42	1
4405A-1	1"	35	42	1
4405A-1-1/16	1-1/16"	36.5	43	1
4405A-1-1/8	1-1/8"	39	43	1
4405A-1-3/16	1-3/16"	40	46	1
4405A-1-1/4	1-1/4"	42.8	46	1
4405A-1-5/16	1-5/16"	44.2	47	1
4405A-1-3/8	1-3/8"	46.2	47	1
4405A-1-7/16	1-7/16"	47.2	47	1
4405A-1-1/2	1-1/2"	49.2	47	1

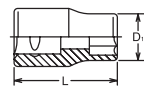

SURFACE DRIVE

CHIAVI A BUSSOLA A MANO BOCCA SURFACE DRIVE



Koken articolo	 mm	D ₁ mm	L mm	
4410M-8	8	13.2	36	1
4410M-9	9	13.8	37	1
4410M-10	10	15.3	37	1
4410M-11	11	16.5	37	1
4410M-12	12	17.8	37	1
4410M-13	13	19	37	1
4410M-14	14	20.3	37	1
4410M-15	15	21.5	37	1
4410M-16	16	22.8	37	1
4410M-17	17	24	37	1
4410M-18	18	25	37	1
4410M-19	19	26.5	38	1
4410M-20	20	27.8	38	1
4410M-21	21	29	38	1
4410M-22	22	30	40	1
4410M-23	23	31.5	40	1
4410M-24	24	32.8	42	1
4410M-25	25	34	42	1
4410M-26	26	35	42	1
4410M-27	27	36.5	43	1
4410M-28	28	37.8	43	1
4410M-29	29	39	43	1
4410M-30	30	40	46	1
4410M-31	31	41.5	46	1
4410M-32	32	42.8	46	1
4410M-34	34	45.2	47	1

1/2"



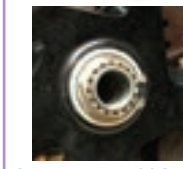

ESAGONO

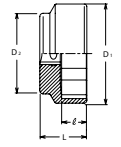

CHIAVI A BUSSOLA A MANO BOCCA ESAGONALE EXTRA CORTE PER DADO CENTRALE CATENA-RUOTA



Koken articolo	 mm	D ₁ mm	L mm	
4400M-DU-41	41	53	28	1
4400M-DU-46	46	59	28	1

1/2"





POLIGONALE

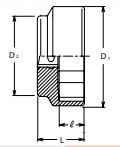

CHIAVI A BUSSOLA A MANO BOCCA POLIGONALE EXTRA CORTE PER DADO ASSE POSTERIORE MOTO



Koken articolo	 mm	D ₁ mm	L mm	
4405M-DU-36	36	47.3	28	1
4405M-DU-55	55	71	31	1

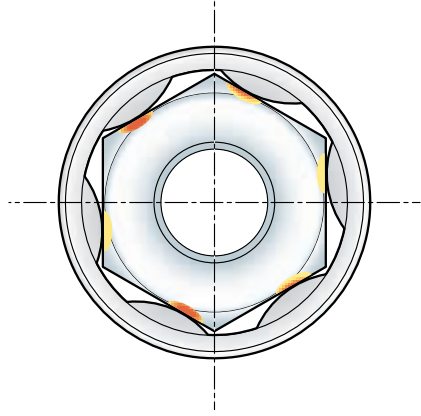

BUSSOLE SURFACE DRIVE



OTTAGONALE OTTO ANGOLI

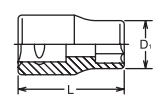

CHIAVI A BUSSOLA A MANO BOCCA OTTAGONALE



Koken articolo	 mm	D ₁ mm	L mm	
4109M-14	14	26	38	1
4109M-17	17	28	40	1
4109M-19	19	29	40	1
4109M-21.5	21.5	32	40	1
4109M-23	23	34	43	1





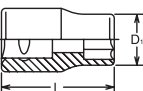

KOKEN 1/2"

CHIAVI A BUSSOLA A MANO BOCCA TORX®





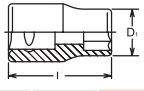

Koken articolo		D ₁ mm	L mm	
4425-E8	E 8	10.7	36	1
4425-E10	E 10	13.2	36	1
4425-E11	E 11	13.8	37	1
4425-E12	E 12	14.6	37	1
4425-E14	E 14	16.5	37	1
4425-E16	E 16	19	37	1
4425-E18	E 18	20.3	37	1
4425-E20	E 20	22.8	37	1
4425-E22	E 22	25	37	1
4425-E24	E 24	26.5	40	1

CHIAVI A BUSSOLA BOCCA TORX PLUS®





Koken articolo		D ₁ mm	L mm	
4425-10EPL	10EPL	13.2	36	1
4425-12EPL	12EPL	14.6	37	1
4425-14EPL	14EPL	16.5	37	1
4425-16EPL	16EPL	19.0	37	1
4425-18EPL	18EPL	20.3	37	1
4425-20EPL	20EPL	22.9	37	1

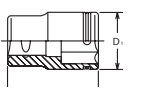

CHIAVI A BUSSOLA A MANO BOCCA NUT GRIP®



Koken articolo		D ₁ mm	L mm	
4450M-10	10	15.3	36	1
4450M-11	11	16.5	36	1
4450M-12	12	17.8	36	1
4450M-13	13	19	36	1
4450M-14	14	20.3	36	1
4450M-15	15	21.5	36	1
4450M-16	16	22.8	36	1
4450M-17	17	24	36	1
4450M-18	18	25	36	1
4450M-19	19	26.5	36	1
4450M-21	21	29	37	1
4450M-22	22	30	37	1
4450M-24	24	32.8	39	1
4450M-27	27	36.5	40	1



TORX®	S mm	S mm	
E 4	3.70	E 16	14.60
E 5	4.60	E 18	16.50
E 6	5.60	E 20	18.30
E 7	6.10	E 22	20.10
E 8	7.40	E 24	22.00
E 10	9.30	E 26	23.70
E 11	9.90	E 28	25.50
E 12	11.00	E 30	27.30
E 14	12.80	E 32	29.00

TORX PLUS®	S mm	S mm	
E 4	3.70	E 16	14.60
E 5	4.60	E 18	16.50
E 6	5.60	E 20	18.30
E 7	6.10	E 22	20.10
E 8	7.40	E 24	22.00
E 10	9.30	E 26	23.70
E 11	9.90	E 28	25.50
E 12	11.00	E 30	27.30
E 14	12.80	E 32	29.00

CHIAVI A BUSSOLA A MANO BOCCA SYSTEM 6

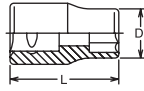

Koken articolo		D mm	L mm	
4400LH-6S	6S	17.3	36	1
4400LH-8S	8S	17.3	37	1
4400LH-10S	10S	17.3	37	1
4400LH-12S	12S	17.3	37	1
4400LH-14S	14S	17.3	37	1
4400LH-16S	16S	17	38	1



CHIAVI A BUSSOLA A MANO BOCCA TORX® PER BULLONI A BASSO PROFILO

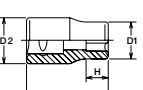

A: Bullone volano MR20 NISSAN: 4425-E20N
 B: BULLONE Pignone FA20 per TOYOTA / SUBARU: 4425-E16N
 C: Bullone biella FA20 per TOYOTA / SUBARU: 4425-E14N

Koken articolo		D ₁ mm	L mm	
4425-E10N	E 10	13.2	36	1
4425-E12N	E 12	14.6	37	1
4425-E14N	E 14	16.5	37	1
4425-E16N	E 16	19	37	1
4425-E18N	E 18	20.3	37	1
4425-E20N	E 20	22.8	37	1

LHSTIX®	d mm	D mm
LH 3 S	3.80	4.70
LH 4 S	4.50	6.00
LH 5 S	5.60	7.50
LH 6 S	6.80	9.00
LH 7 S	7.90	10.50
LH 8 S	9.00	12.00
LH 10 S	11.30	15.00
LH 12 S	13.60	18.00
LH 14 S	15.80	21.00
LH 16 S	18.10	24.00

novità



1/2"

Tamper-Resistant TORX Plus® Sockets



PER TESLA

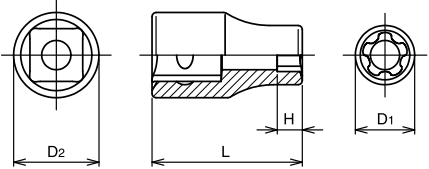

BUSSOLE, TORX PLUS EPR 5 PT





Koken articolo		D1 mm	D2 mm	H mm	L mm
4425-10 EPRL	10 EPRL	13.2	21	6.2	36
4425-12 EPRL	12 EPRL	14.6	21	7.2	37
4425-14 EPRL	14 EPRL	16.5	21	8.1	37
4425-20 EPRL	20 EPRL	22.9	22	11.2	37

- CARATTERISTICHE**
- impronta Torx Plus EPR 5 PT
 - per Tesla

KOKEN O 1/2"







SERIE 10 PZ. CHIAVI A BUSSOLA
MISURE: 10, 11, 12, 13, 14, 15, 16, 17, 18, 19 MM

Koken articolo		
RS 4401M/10		1
RS 4406M/10		1
RS 4410M/10		1

POLLICI





SERIE 10 PZ. CHIAVI A BUSSOLA BOCCA ESAGONALE
MISURE: 3/8", 7/16", 1/2", 9/16", 5/8", 11/16", 3/4", 13/16", 7/8", 15/16"

Koken articolo		
RS 4400A/10		1
RS 4405A/10		1



SERIE 7 PZ. CHIAVI A BUSSOLA BOCCA TORX®



Koken articolo		
RS 4425/7	E10, E12, E14, E16, E18, E20, E24	1



SERIE 14 PZ. CHIAVI A BUSSOLA BOCCA TORX®



Koken articolo	
RSX 425/14	1

CONTENUTO

	2425	E4, E5, E6, E7, E8
	3425	E10, E11, E12, E14
	4425	E16, E18, E20, E22, E24



SERIE 6 PZ. CHIAVI A BUSSOLA BOCCA TORX® PER BULLONI A BASSO PROFILO

Koken articolo		
RS 4425/6-N	E10N, E12N, E14N, E16N, E18N, E20N	1





SYSTEM 6 RIBE

SERIE 6 PZ. CHIAVI A BUSSOLA BOCCA SYSTEM 6

Koken articolo		
RS 4400LH/6	6S, 8S, 10S, 12S, 14S, 16S	1





SERIE 6 PZ. CHIAVI A BUSSOLA BOCCA TORX PLUS®

Koken articolo		
RS 4425/6-EPL	10EPL, 12EPL, 14EPL, 16EPL, 18EPL, 20EPL	1

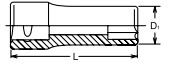

CHIAVI A BUSSOLA A MANO BOCCA ESAGONALE LUNGHE





Koken articolo		D ₁ mm	L mm	
4300M-8	8	13.2	77	1
4300M-9	9	13.8	77	1
4300M-10	10	15.3	77	1
4300M-11	11	16.5	77	1
4300M-12	12	17.8	77	1
4300M-13	13	19	77	1
4300M-14	14	20.3	77	1
4300M-15	15	21.5	77	1
4300M-16	16	22.8	77	1
4300M-17	17	24	77	1
4300M-18	18	25	77	1
4300M-19	19	26.5	77	1
4300M-20	20	27.8	77	1
4300M-21	21	29	77	1
4300M-22	22	30	77	1
4300M-23	23	31.5	77	1
4300M-24	24	32.8	77	1
4300M-25	25	34	77	1
4300M-26	26	35	77	1
4300M-27	27	36.5	77	1
4300M-28	28	37.8	77	1
4300M-29	29	39	77	1
4300M-30	30	40	77	1
4300M-31	31	41.5	77	1
4300M-32	32	42.8	77	1
4300M-33	33	44.2	77	1
4300M-34	34	45.2	77	1
4300M-35	35	46.2	77	1
4300M-36	36	47.2	77	1
4300M-37	37	48.2	77	1
4300M-38	38	49	77	1

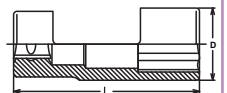

CHIAVI A BUSSOLA A MANO BOCCA ESAGONALE PER SONDE LAMBDA





Koken articolo		D mm	L mm	
SP 4300M-85	22	33	85	1
SP 4300M-110	22	33	110	1

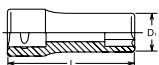

POLIGONALE

**CHIAVI A BUSSOLA
A MANO BOCCA
POLIGONALE LUNGHE**



Koken articolo	 mm	D ₁ mm	L mm	
4305M-8	8	13.2	77	1
4305M-9	9	13.8	77	1
4305M-10	10	15.3	77	1
4305M-11	11	16.5	77	1
4305M-12	12	17.8	77	1
4305M-13	13	19	77	1
4305M-14	14	20.3	77	1
4305M-15	15	21.5	77	1
4305M-16	16	22.8	77	1
4305M-17	17	24	77	1
4305M-18	18	25	77	1
4305M-19	19	26.5	77	1
4305M-20	20	27.8	77	1
4305M-21	21	29	77	1
4305M-22	22	30	77	1
4305M-23	23	31.5	77	1
4305M-24	24	32.8	77	1
4305M-25	25	34	77	1
4305M-26	26	35	77	1
4305M-27	27	36.5	77	1
4305M-28	28	37.8	77	1
4305M-29	29	39	77	1
4305M-30	30	40	77	1
4305M-31	31	41.5	77	1
4305M-32	32	42.8	77	1
4305M-33	33	44.2	77	1
4305M-34	34	45.2	77	1
4305M-35	35	46.2	77	1
4305M-36	36	47.2	77	1
4305M-37	37	48.2	77	1
4305M-38	38	49	77	1



POLLICI

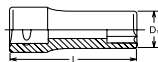

ESAGONO

**CHIAVI A BUSSOLA
A MANO BOCCA
ESAGONALE LUNGHE**



Koken articolo	 pollici	D ₁ mm	L mm	
4300A-5/16	5/16"	13.2	77	1
4300A-3/8	3/8"	14.6	77	1
4300A-7/16	7/16"	16.5	77	1
4300A-1/2	1/2"	19	77	1
4300A-9/16	9/16"	20.3	77	1
4300A-19/32	19/32"	21.5	77	1
4300A-5/8	5/8"	22.8	77	1
4300A-21/32	21/32"	24	77	1
4300A-11/16	11/16"	25	77	1
4300A-3/4	3/4"	26.5	77	1
4300A-25/32	25/32"	27.8	77	1
4300A-13/16	13/16"	29	77	1
4300A-7/8	7/8"	30	77	1
4300A-15/16	15/16"	32.8	77	1
4300A-31/32	31/32"	34	77	1
4300A-1	1"	34	77	1
4300A-1-1/16	1-1/16"	36.5	77	1
4300A-1-1/8	1-1/8"	37.8	77	1
4300A-1-3/16	1-3/16"	40	77	1
4300A-1-1/4	1-1/4"	42.8	77	1
4300A-1-5/16	1-5/16"	44.2	77	1
4300A-1-3/8	1-3/8"	46.2	77	1
4300A-1-7/16	1-7/16"	48	77	1
4300A-1-1/2	1-1/2"	49	77	1
4300A-1-13/16	1-13/16"	59	77	1



POLLICI

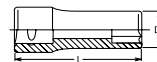

POLIGONALE

**CHIAVI A BUSSOLA
A MANO BOCCA
POLIGONALE LUNGHE**



Koken articolo	 mm	D ₁ mm	L mm	
4305A-5/16	5/16"	13.2	77	1
4305A-3/8	3/8"	14.6	77	1
4305A-7/16	7/16"	16.5	77	1
4305A-1/2	1/2"	19	77	1
4305A-9/16	9/16"	20.3	77	1
4305A-19/32	19/32"	21.5	77	1
4305A-5/8	5/8"	22.8	77	1
4305A-21/32	21/32"	24	77	1
4305A-11/16	11/16"	25	77	1
4305A-3/4	3/4"	26.5	77	1
4305A-25/32	25/32"	27.8	77	1
4305A-13/16	13/16"	29	77	1
4305A-7/8	7/8"	30	77	1
4305A-15/16	15/16"	32.8	77	1
4305A-31/32	31/32"	34	77	1
4305A-1	1"	32.8	77	1
4305A-1-1/16	1-1/16"	36.5	77	1
4305A-1-1/8	1-1/8"	37.8	77	1
4305A-1-3/16	1-3/16"	40	77	1
4305A-1-1/4	1-1/4"	42.8	77	1
4305A-1-5/16	1-5/16"	44.2	77	1
4305A-1-3/8	1-3/8"	46.2	77	1
4305A-1-7/16	1-7/16"	48	77	1
4305A-1-1/2	1-1/2"	49	77	1
4305A-1-13/16	1-13/16"	59	77	1





 1/2"

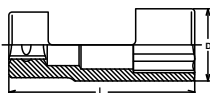

**CHIAVI A BUSSOLA
A MANO BOCCA
POLIGONALE PER
INIETTORI MOTORI
DIESEL**



Koken articolo	 mm	D mm	L mm	
SP 4305M-77	27	36,5	77	1



KOKEN 1/2"



CHIAVI A BUSSOLA
A MANO BOCCA
SURFACE DRIVE

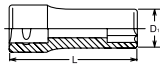

LUNGHE

Koken articolo	mm	D mm	L mm	
4310M-8	8	13.2	77	1
4310M-9	9	13.8	77	1
4310M-10	10	15.3	77	1
4310M-11	11	16.5	77	1
4310M-12	12	17.8	77	1
4310M-13	13	19	77	1
4310M-14	14	20.3	77	1
4310M-15	15	21.5	77	1
4310M-16	16	22.8	77	1
4310M-17	17	24	77	1
4310M-18	18	25	77	1
4310M-19	19	26.5	77	1
4310M-20	20	27.8	77	1
4310M-21	21	29	77	1
4310M-22	22	30	77	1
4310M-23	23	31.5	77	1
4310M-24	24	32.8	77	1
4310M-25	25	34	77	1
4310M-26	26	35	77	1
4310M-27	27	36.5	77	1
4310M-28	28	37.8	77	1
4310M-29	29	39	77	1
4310M-30	30	40	77	1
4310M-31	31	41.5	77	1
4310M-32	32	42.8	77	1
4310M-34	34	45.2	77	1

BUSSOLE SURFACE DRIVE

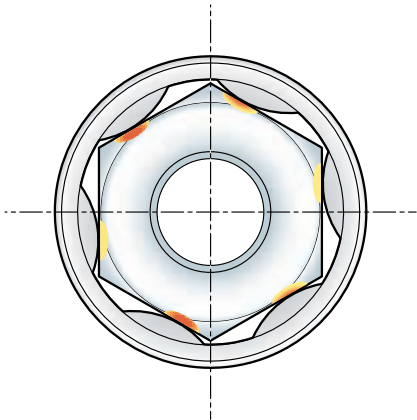

CHIAVI A BUSSOLA
A MANO BOCCA TORX®
LUNGHE

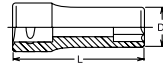

Koken articolo		D mm	L mm	
4325-E 8	E 8	10.7	77	1
4325-E10	E 10	13.2	77	1
4325-E11	E 11	13.8	77	1
4325-E12	E 12	14.6	77	1
4325-E14	E 14	16.5	77	1
4325-E16	E 16	19	77	1
4325-E18	E 18	20.3	77	1
4325-E20	E 20	22.8	77	1
4325-E22	E 22	25	77	1
4325-E24	E 24	26.6	77	1

TORX®	S mm	S mm	
E 4	3.70	E 16	14.60
E 5	4.60	E 18	16.50
E 6	5.60	E 20	18.30
E 7	6.10	E 22	20.10
E 8	7.40	E 24	22.00
E 10	9.30	E 26	23.70
E 11	9.90	E 28	25.50
E 12	11.00	E 30	27.30
E 14	12.80	E 32	29.00



CHIAVI A BUSSOLA
A MANO BOCCA
OTTAGONALE

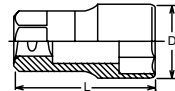

Koken articolo	mm	D mm	L mm	
4300H-27-8P	27	34	57	1

per interruttori, Mercedes Benz e MAN



SERIE 10 PZ. CHIAVI A BUSSOLA LUNGHE
MISURE: 10, 11, 12, 13, 14, 15, 17
19, 21, 22 MM

Koken articolo		
RS 4300M/10		1
RS 4305M/10		1
RS 4310M/10		1

POLLICI



SERIE 10 PZ. CHIAVI A BUSSOLA LUNGHE
MISURE: 3/8", 7/16", 1/2", 9/16", 5/8",
11/16", 3/4", 13/16", 7/8", 15/16"

Koken articolo		
RS 4300A/10		1
RS 4305A/10		1



SERIE 7 PZ. CHIAVI A BUSSOLA BOCCA TORX®

Koken articolo		
RS 4325/7	E10, E12, E14, E16, E18, E20, E24	1



CHIAVI A BUSSOLA
A MANO BOCCA
ESAGONALE





Koken articolo	mm	D mm	L mm	
4300M-L110-17	17	23	110	1
4300M-L110-19	19	25.8	110	1
4300M-L110-21	21	26.8	110	1

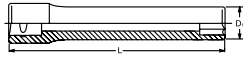

 **ESAGONO**

**CHIAVI A BUSSOLA
A MANO BOCCA
ESAGONALE**





Koken articolo	 mm	D mm	L mm	
4300M-L120-8	8	13.2	120	1
4300M-L120-10	10	15.3	120	1
4300M-L120-12	12	17.8	120	1
4300M-L120-14	14	20.3	120	1
4300M-L120-16	16	22.8	120	1



 **TORX®**

**CHIAVI A BUSSOLA
A MANO BOCCA
TORX®**





Koken articolo	 mm	D mm	L mm	
4325-L140-E 8	E 8	10.7	140	1
4325-L140-E10	E 10	13.2	140	1
4325-L140-E12	E 12	14.6	140	1
4325-L140-E14	E 14	16.5	140	1

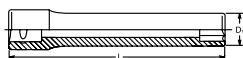

 **TORX BLOCCADADI**

**CHIAVI A BUSSOLA
A MANO BOCCA
TORX® BLOCCADADI**





Koken articolo	 mm	D mm	L mm	
4325-L140-2B-E 8	E 8	10.7	140	1
4325-L140-2B-E10	E 10	13.2	140	1
4325-L140-2B-E12	E 12	14.6	140	1
4325-L140-2B-E14	E 14	16.5	140	1



 **POLIGONALE**

**CHIAVI A BUSSOLA
A MANO BOCCA
POLIGONALE
LUNGHE**



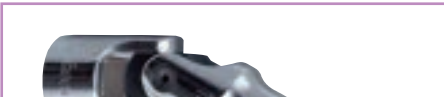

Koken articolo	 mm	D mm	L mm	
4117M-125-13	13	18.7	125	1
4117M-125-14	14	20.2	125	1
4117M-125-17	17	24	125	1
4117M-125-19	19	26.9	125	1
4117M-125-21	21	28.5	125	1
4117M-125-22	22	30	125	1
4117M-125-24	24	32	125	1
4117M-125-27	27	36.5	125	1
4117M-125-30	30	40	125	1
4117M-125-32	32	42	125	1
4117M-250-13	13	18.7	250	1
4117M-250-14	14	20.2	250	1
4117M-250-17	17	24	250	1
4117M-250-19	19	26.9	250	1
4117M-250-21	21	28.5	250	1
4117M-250-22	22	30	250	1
4117M-250-24	24	32	250	1
4117M-250-27	27	36.5	250	1
4117M-250-30	30	40	250	1
4117M-250-32	32	42	250	1

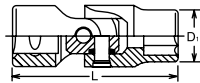

 **ESAGONO**

**CHIAVI A BUSSOLA A
MANO SNODATE
BOCCA ESAGONALE**



Koken articolo	 mm	D ₁ mm	L mm	
4440M-9	9	14	62.8	1
4440M-10	10	15.3	63.3	1
4440M-11	11	16.5	64.5	1
4440M-12	12	17.8	65	1
4440M-13	13	19	65.9	1
4440M-14	14	20.3	65.9	1
4440M-15	15	21.5	67.5	1
4440M-16	16	22.8	68	1
4440M-17	17	24	69	1
4440M-18	18	25.3	69	1
4440M-19	19	26.5	71	1
4440M-20	20	27.8	71	1
4440M-21	21	29	72	1
4440M-22	22	30.3	72	1



POLLICI

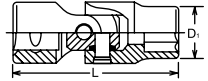

 **ESAGONO**

**CHIAVI A BUSSOLA A
MANO SNODATE
BOCCA ESAGONALE**





Koken articolo	 pollici	D mm	L mm	
4440A-3/8	3/8"	14.8	63.3	1
4440A-7/16	7/16"	16.5	64.5	1
4440A-1/2	1/2"	19	65.9	1
4440A-9/16	9/16"	20.3	65.9	1
4440A-5/8	5/8"	22.8	68	1
4440A-11/16	11/16"	24.6	69	1
4440A-3/4	3/4"	26.5	71	1
4440A-7/8	7/8"	30.3	72	1

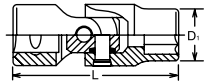

 **POLIGONALE**

**CHIAVI A BUSSOLA A
MANO SNODATE
BOCCA ESAGONALE**



Koken articolo	 mm	D ₁ mm	L mm	
4445M-10	10	15.3	63	1
4445M-12	12	17.8	65	1
4445M-13	13	19	66	1
4445M-14	14	20.3	66	1
4445M-17	17	24	69	1
4445M-19	19	26.5	71	1
4445M-21	21	29	72	1
4445M-22	22	30.3	72	1



POLLICI

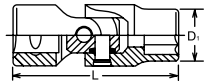

 **POLIGONALE**

**CHIAVI A BUSSOLA A
MANO SNODATE
BOCCA ESAGONALE**





Koken articolo	 pollici	D mm	L mm	
4445A-3/8	3/8"	14.8	63	1
4445A-7/16	7/16"	16.5	65	1
4445A-1/2	1/2"	19	66	1
4445A-9/16	9/16"	20.3	66	1
4445A-5/8	5/8"	22.8	68	1
4445A-11/16	11/16"	24.6	69	1

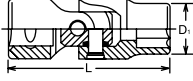

CHIAVI A BUSSOLA A MANO SNODATE BOCCA TORX





Koken articolo		D mm	L mm	
4440T-E10	E 10	13.2	62	1
4440T-E12	E 12	15	63.3	1
4440T-E14	E 14	16.3	64.5	1
4440T-E16	E 16	18.8	65	1
4440T-E18	E 18	20.4	66.5	1

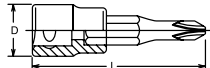

CHIAVI A BUSSOLA A CROCE PHILLIPS®





Koken articolo		D mm	L mm	
4000-60 (PH)-2	PH2	22	60	1
4000-60 (PH)-3	PH3	22	60	1
4000-60 (PH)-4	PH4	22	60	1

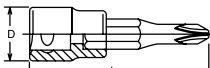

CHIAVI A BUSSOLA A CROCE POZIDRIV®





Koken articolo		D mm	L mm	
4000-60-PZ2	PZ2	22	60	1
4000-60-PZ3	PZ3	22	60	1

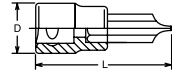

CHIAVI A BUSSOLA A TAGLIO





Koken articolo		D mm	L mm	
4005-60-8	1.2x8	22	60	1
4005-60-10	1,6x10	22	60	1
4005-60-12	2,0x12	23	60	1
4005-60-14	2,5x14	23	60	1
4005-60-16	2,5x16	24	60	1

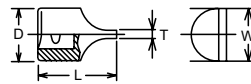

CHIAVI A BUSSOLA A TAGLIO





Koken articolo		T x W	D mm	L mm	
4101-1		2.7x18.6	22	40	1
4101-2		3.7x24	24	40	1
4101-3		3.7x30	30	40	1

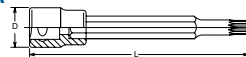

CHIAVI A BUSSOLA MASCHIO POLIGONALE PER TOYOTA





Koken articolo		D mm	L mm	
4010M-100-8-12P	8	23	100	1
4010M-100-10-12P	10	23	100	1
4010M-120-8-12P	8	23	120	1
4010M-120-10-12P	10	23	120	1

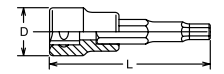

CHIAVI A BUSSOLA MASCHIO ESAGONALE



Koken articolo		D mm	L mm	
4010M-50-4	4	22	50	1
4010M-50-5	5	22	50	1
4010M-50-6	6	22	50	1
4010M-50-7	7	22	50	1
4010M-50-8	8	22	50	1
4010M-50-9	9	22	50	1
4010M-50-10	10	22	50	1
4010M-50-12	12	23	50	1
4010M-50-13	13	24	50	1
4010M-50-14	14	24	50	1
4010M-50-16	16	25	50	1
4010M-50-17	17	25	50	1
4010M-50-18	18	27	50	1
4010M-50-19	19	27	50	1
4010M-75-4	4	22	75	1
4010M-75-5	5	22	75	1
4010M-75-6	6	22	75	1
4010M-75-7	7	22	75	1
4010M-75-8	8	22	75	1
4010M-75-9	9	22	75	1
4010M-75-10	10	22	75	1
4010M-75-11	11	23	75	1
4010M-75-12	12	23	75	1
4010M-75-13	13	24	75	1
4010M-75-14	14	24	75	1
4010M-75-16	16	25	75	1
4010M-75-17	17	25	75	1
4010M-75-18	18	27	75	1
4010M-75-19	19	27	75	1
4010M-100-4	4	22	100	1
4010M-100-5	5	22	100	1
4010M-100-6	6	22	100	1
4010M-100-7	7	22	100	1
4010M-100-8	8	22	100	1
4010M-100-9	9	22	100	1
4010M-100-10	10	22	100	1
4010M-100-12	12	23	100	1
4010M-100-13	13	24	100	1
4010M-100-14	14	24	100	1
4010M-100-16	16	25	100	1
4010M-100-17	17	25	100	1
4010M-100-18	18	27	100	1
4010M-100-19	19	27	100	1
4010M-160-4	4	22	160	1
4010M-160-5	5	22	160	1
4010M-160-6	6	22	160	1
4010M-160-7	7	22	160	1
4010M-160-8	8	22	160	1
4010M-160-10	10	22	160	1
4010M-160-12	12	23	160	1
4010M-160-14	14	24	160	1
4010M-160-17	17	25	160	1
4010M-160-19	19	27	160	1



POLLICI



CHIAVI A BUSSOLA MASCHIO ESAGONALE IN POLLICI

Koken articolo	pollici	D mm	L mm	
4010A-60-5/32	5/32"	22	60	1
4010A-60-3/16	3/16"	22	60	1
4010A-60-7/32	7/32"	22	60	1
4010A-60-1/4	1/4"	22	60	1
4010A-60-9/32	9/32"	22	60	1
4010A-60-5/16	5/16"	22	60	1
4010A-60-11/32	11/32"	22	60	1
4010A-60-3/8	3/8"	22	60	1
4010A-60-7/16	7/16"	23	60	1
4010A-60-1/2	1/2"	24	60	1
4010A-60-9/16	9/16"	25	60	1
4010A-60-5/8	5/8"	25	60	1
4010A-60-3/4	3/4"	27	60	1



ESAGONO

SERIE 10 PZ. CHIAVI A BUSSOLA MASCHIO ESAGONALE

Koken articolo	pollici	L mm	
RS 4010M/10-L50	4, 5, 6, 7, 8, 10, 12, 14, 17, 19 mm	50	1
RS 4010M/10-L75	4, 5, 6, 7, 8, 10, 12, 14, 17, 19 mm	75	1
RS 4010A/10-L60	3/16", 7/32", 1/4", 5/16", 3/8", 7/16", 1/2", 9/16", 5/8", 3/4"	60	1

POLLICI



CHIAVI A BUSSOLA MASCHIO ESAGONALE INTEGRALI

Koken articolo	mm	D mm	L mm	
4012M-43-4	4	21.1	43	1
4012M-43-5	5	21.1	43	1
4012M-43-6	6	21.1	43	1
4012M-43-7	7	21.1	43	1
4012M-43-8	8	21.1	43	1
4012M-43-9	9	21.1	43	1
4012M-43-10	10	23	43	1
4012M-43-11	11	24	43	1
4012M-43-12	12	24	43	1
4012M-43-13	13	24	43	1
4012M-43-14	14	24	43	1
4012M-43-15	15	24	43	1
4012M-43-16	16	24	43	1
4012M-43-17	17	24	43	1
4012M-43-18	18	24	43	1
4012M-43-19	19	24	43	1
4012M-43-20	20	24	43	1
4012M-43-21	21	24	43	1
4012M-43-22	22	24	43	1
4012M-43-23	23	24	43	1
4012M-43-24	24	24	43	1
4012M-43-27	27	24	43	1
4012M-60-4	4	21.1	60	1
4012M-60-5	5	21.1	60	1
4012M-60-6	6	21.1	60	1
4012M-60-7	7	21.1	60	1
4012M-60-8	8	21.1	60	1
4012M-60-9	9	21.1	60	1
4012M-60-10	10	23	60	1
4012M-60-11	11	24	60	1
4012M-60-12	12	24	60	1
4012M-60-13	13	24	60	1
4012M-60-14	14	24	60	1
4012M-60-15	15	24	60	1
4012M-60-16	16	24	60	1
4012M-60-17	17	24	60	1
4012M-60-18	18	24	60	1
4012M-60-19	19	24	60	1
4012M-60-21	21	24	60	1
4012M-60-22	22	24	60	1
4012M-60-23	23	24	60	1
4012M-60-24	24	24	60	1



CHIAVI A BUSSOLA MASCHIO ESAGONALE INTEGRALI

Koken articolo	mm	D mm	L mm	
4012M-75-4	4	21.1	75	1
4012M-75-5	5	21.1	75	1
4012M-75-6	6	21.1	75	1
4012M-75-7	7	21.1	75	1
4012M-75-8	8	21.1	75	1
4012M-75-9	9	21.1	75	1
4012M-75-10	10	23	75	1
4012M-75-11	11	24	75	1
4012M-75-12	12	24	75	1
4012M-75-13	13	24	75	1
4012M-75-14	14	24	75	1
4012M-75-15	15	24	75	1
4012M-75-16	16	24	75	1
4012M-75-17	17	24	75	1
4012M-75-18	18	24	75	1
4012M-75-19	19	24	75	1
4012M-75-22	22	26	75	1
4012M-75-24	24	27.9	75	1
4012M-100-4	4	21.1	100	1
4012M-100-5	5	21.1	100	1
4012M-100-6	6	21.1	100	1
4012M-100-7	7	21.1	100	1
4012M-100-8	8	21.1	100	1
4012M-100-9	9	21.1	100	1
4012M-100-10	10	23	100	1
4012M-100-11	11	24	100	1
4012M-100-12	12	24	100	1
4012M-100-13	13	24	100	1
4012M-100-14	14	24	100	1
4012M-100-15	15	24	100	1
4012M-100-16	16	24	100	1
4012M-100-17	17	24	100	1
4012M-100-18	18	24	100	1
4012M-100-19	19	24	100	1



ESAGONO

SERIE 10 PZ. CHIAVI A BUSSOLA BOCCA ESAGONALE

Koken articolo	pollici	L mm	
RS 4012M/10-L60	4, 5, 6, 7, 8, 10, 12, 14, 17, 19 mm	60	1
RS 4012A/10-L60	3/16", 7/32", 1/4", 5/16", 3/8", 7/16", 1/2", 9/16", 5/8", 3/4"	60	1

POLLICI

KOKEN 1/2"



POLLICI

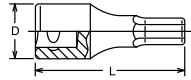

ESAGONO

CHIAVI A BUSSOLA MASCHIO ESAGONALE INTEGRALI





Koken articolo	 pollici	D mm	L mm	
4012A-43-5/32	5/32"	21.1	43	1
4012A-43-3/16	3/16"	21.1	43	1
4012A-43-7/32	7/32"	21.1	43	1
4012A-43-1/4	1/4"	21.1	43	1
4012A-43-9/32	9/32"	21.1	43	1
4012A-43-5/16	5/16"	21.1	43	1
4012A-43-11/32	11/32"	21.1	43	1
4012A-43-3/8	3/8"	23	43	1
4012A-43-7/16	7/16"	25	43	1
4012A-43-1/2	1/2"	25	43	1
4012A-43-9/16	9/16"	25	43	1
4012A-43-5/8	5/8"	26	43	1
4012A-43-3/4	3/4"	26	43	1
4012A-43-7/8	7/8"	26	43	1
4012A-60-5/32	5/32"	21.1	60	1
4012A-60-3/16	3/16"	21.1	60	1
4012A-60-7/32	7/32"	21.1	60	1
4012A-60-1/4	1/4"	21.1	60	1
4012A-60-9/32	9/32"	21.1	60	1
4012A-60-5/16	5/16"	21.1	60	1
4012A-60-11/32	11/32"	21.1	60	1
4012A-60-3/8	3/8"	21.5	60	1
4012A-60-7/16	7/16"	24	60	1
4012A-60-1/2	1/2"	24	60	1
4012A-60-9/16	9/16"	24	60	1
4012A-60-5/8	5/8"	24	60	1
4012A-60-3/4	3/4"	24	60	1
4012A-60-7/8	7/8"	26	60	1
4012A-75-5/32	5/32"	21.1	75	1
4012A-75-3/16	3/16"	21.1	75	1
4012A-75-7/32	7/32"	21.1	75	1
4012A-75-1/4	1/4"	21.1	75	1
4012A-75-9/32	9/32"	21.1	75	1
4012A-75-5/16	5/16"	21.1	75	1
4012A-75-11/32	11/32"	21.1	75	1
4012A-75-3/8	3/8"	21.5	75	1
4012A-75-7/16	7/16"	24	75	1
4012A-75-1/2	1/2"	24	75	1
4012A-75-9/16	9/16"	24	75	1
4012A-75-5/8	5/8"	24	75	1
4012A-75-3/4	3/4"	24	75	1
4012A-75-7/8	7/8"	26	75	1
4012A-100-5/32	5/32"	21.1	100	1
4012A-100-3/16	3/16"	21.1	100	1
4012A-100-7/32	7/32"	21.1	100	1
4012A-100-1/4	1/4"	21.1	100	1
4012A-100-9/32	9/32"	21.1	100	1
4012A-100-5/16	5/16"	21.1	100	1
4012A-100-11/32	11/32"	21.1	100	1
4012A-100-3/8	3/8"	21.5	100	1
4012A-100-7/16	7/16"	24	100	1
4012A-100-1/2	1/2"	24	100	1
4012A-100-9/16	9/16"	24	100	1
4012A-100-5/8	5/8"	24	100	1
4012A-100-3/4	3/4"	24	100	1



XZN

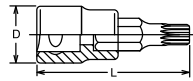

CHIAVI A BUSSOLA MASCHIO XZN



Koken articolo		D mm	L mm	
4020-60-M5	M 5	22	60	1
4020-60-M6	M 6	22	60	1
4020-60-M8	M 8	22	60	1
4020-60-M10	M10	23	60	1
4020-60-M12	M12	23	60	1
4020-60-M14	M14	23	60	1
4020-60-M16	M16	25	60	1
4020-60-M18	M18	27	60	1
4020-100-M5	M 5	22	100	1
4020-100-M6	M 6	22	100	1
4020-100-M8	M 8	22	100	1
4020-100-M10	M10	23	100	1
4020-100-M12	M12	23	100	1
4020-100-M14	M14	23	100	1
4020-100-M16	M16	25	100	1
4020-100-M18	M18	27	100	1
4020-120-M5	M 5	22	120	1
4020-120-M6	M 6	22	120	1
4020-120-M8	M 8	22	120	1
4020-120-M10	M10	23	120	1
4020-120-M12	M12	23	120	1
4020-120-M14	M14	23	120	1
4020-140-M5	M 5	22	140	1
4020-140-M6	M 6	22	140	1
4020-140-M8	M 8	22	140	1
4020-140-M10	M10	23	140	1
4020-140-M12	M12	23	140	1
4020-140-M14	M14	23	140	1



SERIE 6 PZ. CHIAVI A BUSSOLA BOCCA XZN

Koken articolo		L mm	
RS 4020/6-L60	M5, M6, M8, M10, M12, M14	60	1
RS 4020/6-L100	M5, M6, M8, M10, M12, M14	100	1



XZN	S mm	S mm
	M 4 3,60	M12 11,50
	M 5 4,80	M14 13,30
	M 6 6,10	M16 15,70
	M 8 7,30	M18 16,90
	M10 9,70	

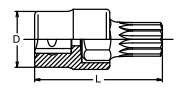

XZN CON FORO

CHIAVI A BUSSOLA MASCHIO XZN CON FORO



Koken articolo		D mm	L mm	
4020-60-MH	MH16	25	60	1

Per tappo della scatola del cambio AUDI, VW, PORSCHE



KOKEN 1/2"



CHIAVI A BUSSOLA MASCHIO TORX®

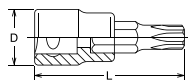

Koken articolo	TORX	D mm	L mm	
4025-60-T15	TX 15	22	60	1
4025-60-T20	TX 20	22	60	1
4025-60-T25	TX 25	22	60	1
4025-60-T27	TX 27	22	60	1
4025-60-T30	TX 30	22	60	1
4025-60-T35	TX 35	22	60	1
4025-60-T40	TX 40	22	60	1
4025-60-T45	TX 45	22	60	1
4025-60-T50	TX 50	22	60	1
4025-60-T55	TX 55	23	60	1
4025-60-T60	TX 60	24	60	1
4025-60-T70	TX 70	24	60	1
4025-60-T80	TX 80	24	60	1
4025-100-T20	TX 20	22	100	1
4025-100-T25	TX 25	22	100	1
4025-100-T27	TX 27	22	100	1
4025-100-T30	TX 30	22	100	1
4025-100-T40	TX 40	22	100	1
4025-100-T45	TX 45	22	100	1
4025-100-T50	TX 50	22	100	1
4025-100-T55	TX 55	23	100	1
4025-100-T60	TX 60	24	100	1
4025-100-T70	TX 70	24	100	1
4025-140-T20	TX 20	22	140	1
4025-140-T25	TX 25	22	140	1
4025-140-T27	TX 27	22	140	1
4025-140-T30	TX 30	22	140	1
4025-140-T40	TX 40	22	140	1
4025-140-T45	TX 45	22	140	1
4025-140-T50	TX 50	22	140	1
4025-140-T55	TX 55	23	140	1
4025-140-T60	TX 60	24	140	1
4025-140-T70	TX 70	24	140	1
4025-140-T80	TX 80	24	140	1



CHIAVI A BUSSOLA MASCHIO TORX® PLUS

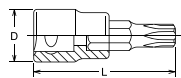

Koken articolo	TORXplus	D mm	L mm	
4025-60-20IP	20IP	22	60	1
4025-60-25IP	25IP	22	60	1
4025-60-27IP	27IP	22	60	1
4025-60-30IP	30IP	22	60	1
4025-60-40IP	40IP	22	60	1
4025-60-45IP	45IP	22	60	1
4025-60-50IP	50IP	22	60	1
4025-60-55IP	55IP	23	60	1
4025-60-60IP	60IP	24	60	1
4025-60-70IP	70IP	25	60	1
4025-100-40IP	40IP	22	100	1
4025-100-45IP	45IP	22	100	1
4025-100-50IP	50IP	22	100	1
4025-100-55IP	55IP	23	100	1
4025-100-60IP	60IP	24	100	1
4025-100-70IP	70IP	25	100	1



SERIE 9 PZ. CHIAVI A BUSSOLA BOCCA TORX® PLUS

Koken articolo	TORXplus	L mm	
RS 4025/9-IP	20IP, 25IP, 27IP, 30IP, 40IP, 45IP, 50IP, 55IP, 60IP	60	1

TORXplus	S mm	S mm	
8 IP	2.30	30 IP	5.60
9 IP	2.50	40 IP	6.70
10 IP	2.70	45 IP	7.90
15 IP	3.30	50 IP	8.90
20 IP	3.90	55 IP	11.30
25 IP	4.50	60 IP	13.30
27 IP	5.00		





SERIE 9 PZ. CHIAVI A BUSSOLA BOCCA TORX®

Koken articolo	TORX	L mm	
RS 4025/9-L60	TX20, TX25, TX27, TX30, TX40, TX45, TX50, TX55, TX60	60	1

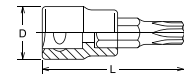

CHIAVI A BUSSOLA MASCHIO RIBE



Koken articolo	RIBE	D mm	L mm	
4027-60-M5	M 5	22	60	1
4027-60-M6	M 6	22	60	1
4027-60-M7	M 7	22	60	1
4027-60-M8	M 8	22	60	1
4027-60-M9	M 9	22	60	1
4027-60-M10	M10	22	60	1
4027-60-M12	M12	23	60	1
4027-60-M13	M13	24	60	1
4027-60-M14	M14	24	60	1
4027-60-M16	M16	24	60	1
4027-100-M5	M 5	22	100	1
4027-100-M6	M 6	22	100	1
4027-100-M7	M 7	22	100	1
4027-100-M8	M 8	22	100	1
4027-100-M9	M 9	22	100	1
4027-100-M10	M10	22	100	1
4027-100-M12	M12	23	100	1
4027-100-M13	M13	24	100	1
4027-100-M14	M14	24	100	1
4027-100-M16	M16	24	100	1
4027-140-M8	M8	22	140	1
4027-140-M10	M10	22	140	1
4027-140-M12	M12	23	140	1
4027-140-M14	M14	24	140	1
4027-140-M16	M16	24	140	1



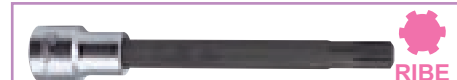

SERIE 7 PZ. CHIAVI A BUSSOLA BOCCA RIBE

Koken articolo	RIBE	L mm	
RS 4027/7-L60	M5, M6, M8, M10, M12, M14, M16	60	1

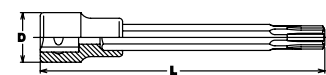

CHIAVI A BUSSOLA MASCHIO RIBE PER VW E AUDI



Koken articolo	D mm	L mm	
ST 4027-140	23	140	1



MECCANISMO 24 DENTI

CRICCHETTO PORTABUSSOLA REVERSIBILE

Koken	D mm	T mm	L mm	
articolo 3749 S-1/2	34	29	110	1



MECCANISMO 24 DENTI

CRICCHETTO PORTABUSSOLA REVERSIBILE

Koken	D mm	T mm	L mm	
articolo 4753 J	38	36,2	250	1



MECCANISMO 24 DENTI

CRICCHETTO PORTABUSSOLA REVERSIBILE TIPO EXTRA LUNGO

Koken	D mm	T mm	L mm	
articolo 4753 P-410	38	36,2	410	1



MECCANISMO 24 DENTI

CRICCHETTO PORTABUSSOLA REVERSIBILE CON PULSANTE DI SBLOCCAGGIO RAPIDO

Koken	D mm	T mm	L mm	
articolo 3749 SB-1/2	34	29	110	1



MECCANISMO 24 DENTI

CRICCHETTO PORTABUSSOLA REVERSIBILE

Koken	D mm	T mm	L mm	
articolo 4753 P	38	36,2	250	1



MECCANISMO 24 DENTI

CRICCHETTO PORTABUSSOLA REVERSIBILE SNODATO - TIPO LUNGO

Koken	D mm	T mm	L mm	
articolo 4774 J	38	36,2	330	1



MECCANISMO 30 DENTI

CRICCHETTO PORTABUSSOLA REVERSIBILE

Koken	D mm	T mm	L mm	
articolo 4750 J	38	35,9	250	1



MECCANISMO 24 DENTI

CRICCHETTO PORTABUSSOLA REVERSIBILE CON PULSANTE DI SBLOCCAGGIO RAPIDO

Koken	D mm	T mm	L mm	
articolo 4753 JB	38	36,2	250	1



MECCANISMO 24 DENTI

CRICCHETTO PORTABUSSOLA REVERSIBILE SNODATO CON PULSANTE DI SBLOCCAGGIO RAPIDO - TIPO LUNGO

Koken	D mm	T mm	L mm	
articolo 4774 JB	38	36,2	330	1



MECCANISMO 30 DENTI

CRICCHETTO PORTABUSSOLA REVERSIBILE CON PULSANTE DI SBLOCCAGGIO RAPIDO

Koken	D mm	T mm	L mm	
articolo 4750 JB	38	35,9	250	1



MECCANISMO 24 DENTI

CRICCHETTO PORTABUSSOLA REVERSIBILE CON PULSANTE DI SBLOCCAGGIO RAPIDO

Koken	D mm	T mm	L mm	
articolo 4753 PB	38	36,2	250	1



MECCANISMO 24 DENTI

CRICCHETTO PORTABUSSOLA REVERSIBILE SNODATO - TIPO LUNGO

Koken	D mm	T mm	L mm	
articolo 4774 P	38	36,2	330	1
articolo 4774 P-450	38	36,2	450	1



MECCANISMO 30 DENTI

CRICCHETTO PORTABUSSOLA REVERSIBILE CON PULSANTE DI SBLOCCAGGIO RAPIDO

Koken	D mm	T mm	L mm	
articolo 4750 PB	38	35,9	250	1



MECCANISMO 24 DENTI

CRICCHETTO PORTABUSSOLA REVERSIBILE TIPO LUNGO

Koken	D mm	T mm	L mm	
articolo 4749 J-380	44,6	33	380	1



MECCANISMO 24 DENTI

CRICCHETTO PORTABUSSOLA REVERSIBILE SNODATO CON PULSANTE DI SBLOCCAGGIO RAPIDO - TIPO LUNGO

Koken	D mm	T mm	L mm	
articolo 4774 PB	38	36,2	330	1



MECCANISMO 45 DENTI

CRICCHETTO PORTABUSSOLA REVERSIBILE

Koken	D mm	T mm	L mm	
articolo 4752 J	35	38,8	250	1



MECCANISMO 45 DENTI

ADATTATORE A CRICCHETTO REVERSIBILE SX/DX

Koken articolo	D mm	L mm	
4755	33,5	65	1



ADATTATORE A MANOPOLA PORTABUSSOLA

SFERA

Koken articolo	D mm	L mm	
4756	38	34.6	1

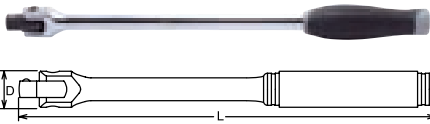

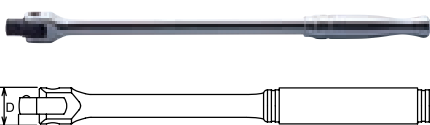

QUADRO MASCHIO SNODATO CON IMPUGNATURA

Koken articolo	D mm	L mm	
4768 J-380	28	380	1
4768 J-450	28	450	1
4768 J-600 <i>novità</i>	28	600	1



QUADRO MASCHIO SNODATO CON IMPUGNATURA

Koken articolo	D mm	L mm	
4768 P-380	28	380	1
4768 P-450	28	450	1
4768 P-600 <i>novità</i>	28	600	1



SFERA

DOPPIO QUADRO MASCHIO AD ANGOLO

Koken articolo	L1 mm	L2 mm	
4747	260	50	1



SFERA

PROLUNGA CON ATTACCO QUADRO

Koken articolo	D mm	L mm	
4760-35 <i>novità</i>	24	35	1
4760-50	24	50	1
4760-75	24	75	1
4760-100	24	100	1
4760-125	24	125	1
4760-150	24	150	1
4760-200	24	200	1
4760-250	24	250	1
4760-300	24	300	1
4760-400	24	400	1
4760-500	24	500	1
4760-600	24	600	1
4760-900	24	900	1
4760-1000	24	1000	1



PK 4760/5

DESCRIZIONE
Set 5 prolunghe con attacco quadro

CARATTERISTICHE
4760   50, 75, 125, 150, 250 mm



SFERA

PROLUNGA CON TESTA SFERICA

SISTEMA WOBBLE-FIX CON DUE MODALITÀ DI UTILIZZO:
- PROLUNGA TESTA SFERICA Wobble
- PROLUNGA TRADIZIONALE Fix
ANGOLO 15°

Koken articolo	D mm	L mm	
4763-50	24	50	1
4763-75	24	75	1
4763-125	24	125	1
4763-150	24	150	1
4763-250	24	250	1
4763-300 <i>novità</i>	24	300	1
4763-400	24	400	1



TESTA SFERICA

SISTEMA WOBBLE-FIX CON DUE MODALITÀ DI UTILIZZO:
- PROLUNGA TESTA SFERICA Wobble
- PROLUNGA TRADIZIONALE Fix
ANGOLO 15°

Koken articolo	DESCRIZIONE
PK 4763/5	Set 5 prolunghe con attacco quadro

CARATTERISTICHE
4763   50, 75, 125, 150, 250 mm



SFERA

SNODO

Koken articolo	L mm	
4770	62,4	1



SFERA

SNODO

Koken articolo	L mm	
4771	58,5	1



SFERA

QUADRO MASCHIO CON MANOVELLA

Koken articolo	H mm	L mm	
4780-400	100	400	1

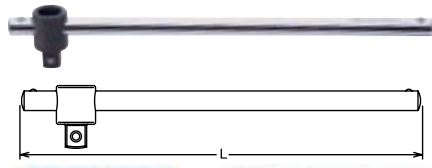

L'innovativa barra a forma ovale offre una maggiore durata e impedisce al quadro scorrevole di ruotare attorno l'asta.



QUADRO MASCHIO CON ASTA SCORREVOLE OVALE

Koken articolo	L mm	
4785 K	300	1

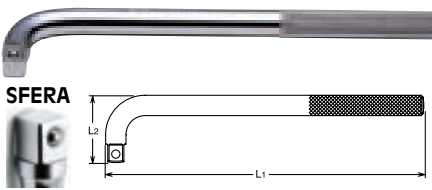

QUADRO MASCHIO AD ANGOLO

Koken articolo	L1 mm	L2 mm	
4788-250K	250	53	1
4788-300K	300	53	1
4788-450K	450	53	1

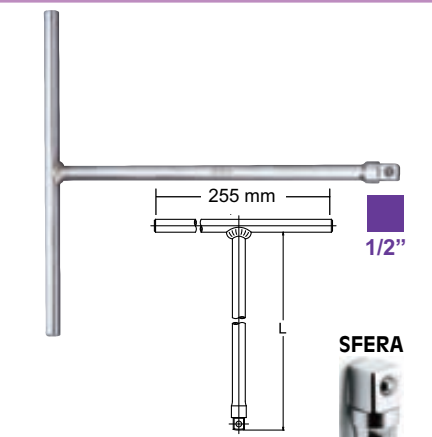

CHIAVI A "T" MASCHIO QUADRO 1/2" LARGHEZZA IMPUGNATURA 255 MM

Koken articolo	pollici	L mm	
4715-1/2	1/2"	267	1

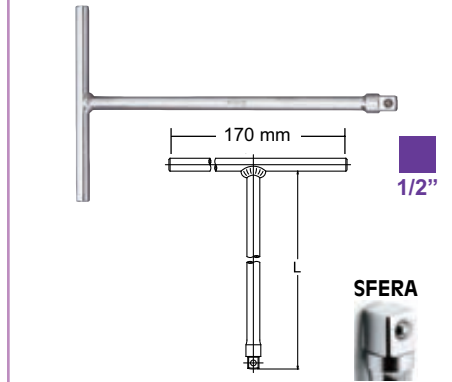

CHIAVI A "T" MASCHIO QUADRO 1/2" LARGHEZZA IMPUGNATURA 170 MM

Koken articolo	pollici	L mm	
4715 S-1/2	1/2"	267	1

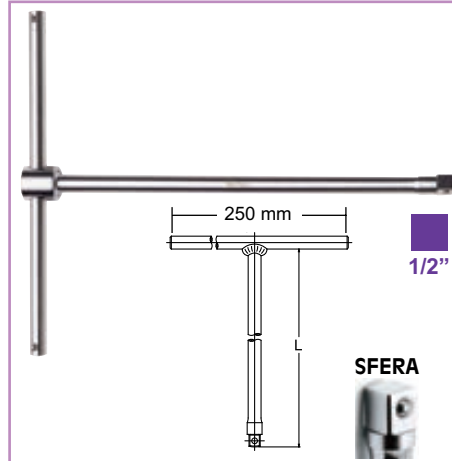

CHIAVI A "T" MASCHIO QUADRO 1/2" CON ASTA SCORREVOLE LARGHEZZA 250 MM

Koken articolo	pollici	L mm	
4715 SL-1/2	1/2"	250	1



RACCORDO DI RIDUZIONE MASCHIO/FEMMINA CON SFERA DI TENUTA NEL QUADRO MASCHIO

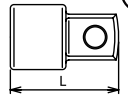

JAPAN

Koken articolo	F	M	L mm	
2233 A	1/4"	3/8"	22	1
3322 A	3/8"	1/4"	24	1
3344 A	3/8"	1/2"	35	1
4433 A-35	1/2"	3/8"	35	1
4433 A-75	1/2"	3/8"	75	1
4433 A-125	1/2"	3/8"	125	1
4433 A-250	1/2"	3/8"	250	1
4433 A-600	1/2"	3/8"	600	1
4466 A	1/2"	3/4"	42	1
6644 A	3/4"	1/2"	47	1
6688 A	3/4"	1"	60	1
8866 A	1"	3/4"	60	1





**SERIE 22 PZ. CHIAVI A BUSSOLA
MISURE METRICHE
BOCCA ESAGONALE / POLIGONALE
CASSETTA METALLICA 330 X 68 X H 48 MM**

Koken articolo	DESCRIZIONE	
4251M-01	10, 11, 12, 13, 14, 15, 16, 17, 18, 19, 20, 21, 22, 23, 24, 25, 26, 27, 28, 29, 30, 32 MM	1
4251M-06	10, 11, 12, 13, 14, 15, 16, 17, 18, 19, 20, 21, 22, 23, 24, 25, 26, 27, 28, 29, 30, 32 MM	1
4251M-10 <i>novità</i>	10, 11, 12, 13, 14, 15, 16, 17, 18, 19, 20, 21, 22, 23, 24, 25, 26, 27, 28, 29, 30, 32 MM	1

POLLICI



**SERIE 18 PZ. CHIAVI A BUSSOLA
MISURE IN POLLICI
BOCCA ESAGONALE / POLIGONALE
CASSETTA METALLICA 330 X 68 X H 48 MM**

Koken articolo	DESCRIZIONE	
4251A-00	3/8", 7/16", 1/2", 9/16", 19/32", 5/8, 21/32", 11/16", 3/4", 25/32", 13/16, 7/8", 15/16", 1", 1-1/16", 1-1/8, 1-3/16", 1-1/4"	1
4251A-05	3/8", 7/16", 1/2", 9/16", 19/32", 5/8, 21/32", 11/16", 3/4", 25/32", 13/16, 7/8", 15/16", 1", 1-1/16", 1-1/8, 1-3/16", 1-1/4"	1







**SERIE 13 PZ. CHIAVI A BUSSOLA
BOCCA ESAGONALE / POLIGONALE
CASSETTA METALLICA 168 X 60 X H 42 MM**

Koken articolo	DESCRIZIONE	
4252M-01	10, 11, 12, 13, 14, 15, 16, 17, 18, 19, 20, 21, 22 MM	1
4252M-06	10, 11, 12, 13, 14, 15, 16, 17, 18, 19, 20, 21, 22 MM	1
4252M-10 <i>novità</i>	10, 11, 12, 13, 14, 15, 16, 17, 18, 19, 20, 21, 22 MM	1



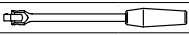

novità

Koken articolo	DESCRIZIONE
4275	Cassetta metallica 24 Pz. 445 x 190 x h 50 mm
RICAMBI	
BUSSOLE ESAGONO	4401M 10, 11, 12, 13, 14, 15, 16, 17, 18, 19, 21, 22, 24
	4300C 16, 20.8
	4300M 17, 19, 21
ACCESSORI	4750N 
	4760-125 
	4760-250 
	4768N-380 
	4770 
	4785 



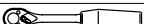

novità

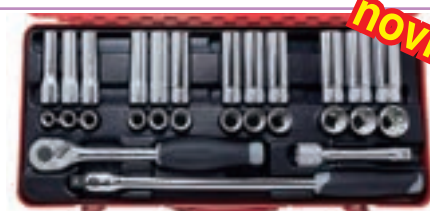
Koken articolo	DESCRIZIONE
4276	Cassetta metallica 17 Pz. 370 x 150 x h 50 mm
RICAMBI	
BUSSOLE ESAGONO	4010M-50 6, 7, 8, 10, 12, 14
BUSSOLE TORX	4025-60 TX20, TX25, TX27, TX30, TX40, TX45, TX50, TX55, TX60
ACCESSORI	4752N  4763-125 

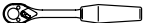

novità

Koken articolo	DESCRIZIONE
4277	Cassetta metallica 27 Pz. 445 x 190 x h 50 mm
RICAMBI	
BUSSOLE POLIGONALE	4405M 10, 12, 13, 14, 15, 16, 17, 18, 19, 21, 22, 24
	4305M 10, 12, 13, 14, 15, 16, 17, 18, 19, 21, 22, 24
ACCESSORI	4750N  4760-125  4768N-380 

KOKEN 1/2"



Koken articolo	DESCRIZIONE	
4249M-01	Cassetta metallica 20 Pz. 445 x 190 x h 50 mm	
RICAMBI		
BUSSOLE ESAGONO	4401M	10, 11, 12, 13, 14, 15, 16, 17, 18, 19, 21, 22, 24, 27, 30
ACCESSORI	4753J	
	4760-125	
	4760-250	
	4768J-380	
	4770	
	4785	



Koken articolo	DESCRIZIONE	
4249M-06	Cassetta metallica 20 Pz. 445 x 190 x h 50 mm	
RICAMBI		
BUSSOLE POLIGONALE	4406M	10, 11, 12, 13, 14, 15, 16, 17, 18, 19, 21, 22, 24, 27, 30
ACCESSORI	4753J	
	4760-125	
	4760-250	
	4768J-380	
	4770	
	4785	



Koken articolo	DESCRIZIONE	
4241M-01	Cassetta metallica 28 Pz. 446 x 266 x h 50 mm	
RICAMBI		
BUSSOLE ESAGONO	4401M	10, 11, 12, 13, 14, 15, 16, 17, 18, 19, 20, 21, 22, 23, 24, 25, 26, 27, 28, 29, 30, 32
ACCESSORI	4753J	
	4760-125	
	4760-250	
	4768J-380	
	4770	
	4785	



Koken articolo	DESCRIZIONE	
4241M-06	Cassetta metallica 28 Pz. 446 x 266 x h 50 mm	
RICAMBI		
BUSSOLE POLIGONALE	4406M	10, 11, 12, 13, 14, 15, 16, 17, 18, 19, 20, 21, 22, 23, 24, 25, 26, 27, 28, 29, 30, 32
ACCESSORI	4753J	
	4760-125	
	4760-250	
	4768J-380	
	4770	
	4785	







Koken articolo	DESCRIZIONE	
4241M-10	Cassetta metallica 28 Pz. 446 x 266 x h 50 mm	
RICAMBI		
BUSSOLE SURFACE DRIVE	4410M	10, 11, 12, 13, 14, 15, 16, 17, 18, 19, 20, 21, 22, 23, 24, 25, 26, 27, 28, 29, 30, 32
ACCESSORI	4753J	
	4760-125	
	4760-250	
	4768J-380	
	4770	
	4785	

POLLICI



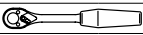

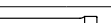
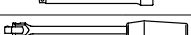
Koken articolo	DESCRIZIONE	
4241A-00	Cassetta metallica 19 Pz. 445 x 190 x h 50 mm	
RICAMBI		
BUSSOLE ESAGONO	4400A	3/8", 7/16", 1/2", 9/16", 5/8", 11/16", 3/4", 13/16", 7/8", 15/16", 1-1/16", 1-1/8", 1-1/4"
ACCESSORI	4753J	
	4760-125	
	4760-250	
	4768J-380	
	4770	
4785		

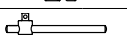





Koken articolo	DESCRIZIONE	
4241A-05	Cassetta metallica 19 Pz. 445 x 190 x h 50 mm	
RICAMBI		
BUSSOLE 	4405A	3/8", 7/16", 1/2", 9/16", 5/8", 11/16", 3/4", 13/16", 7/8", 15/16", 1-1/16", 1-1/8", 1-1/4"
ACCESSORI	4753J	
	4760-125	
	4760-250	
	4768J-380	
	4770	
4785		



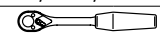

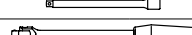

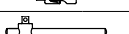
Koken articolo	DESCRIZIONE	
4254	Cassetta metallica 12 Pz. 215 x 80 x h 47 mm	
RICAMBI		
BUSSOLE 	3425	E6 - E8
	4425	E10 - E12 - E14
	3325	E6 - E8
	4325	E10 - E2 - E14
ACCESSORI	4763-50	
	4433A-35	





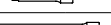

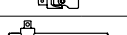
Koken articolo	DESCRIZIONE	
4272AM-06	Cassetta metallica 29 Pz. 445 x 190 x h 50 mm	
RICAMBI		
BUSSOLE 	4406M	10, 11, 12, 13, 14, 15, 16, 17, 18, 19, 21, 22, 24 mm
	4405A	3/8", 7/16", 1/2", 9/16", 5/8", 11/16", 3/4", 13/16", 7/8", 15/16", 1"
ACCESSORI	4753J	
	4760-125	
	4760-250	
	4768J-380	
	4770	
	4785	



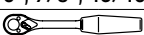

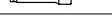
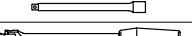

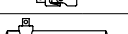
Koken articolo	DESCRIZIONE	
4250M-01	Cassetta metallica 18 Pz. 445 x 190 x h 50 mm	
RICAMBI		
BUSSOLE 	4401M	10, 11, 12, 13, 14, 15, 17, 19, 22, 24, 27, 30, 32
	4753J	
ACCESSORI	4760-125	
	4760-250	
	4770	
	4785	



Koken articolo	DESCRIZIONE	
4272AM-01	Cassetta metallica 29 Pz. 445 x 190 x h 50 mm	
RICAMBI		
BUSSOLE 	4401M	10, 11, 12, 13, 14, 15, 16, 17, 18, 19, 21, 22, 24 mm
	4401A	3/8", 7/16", 1/2", 9/16", 5/8", 11/16", 3/4", 13/16", 7/8", 15/16", 1"
ACCESSORI	4753J	
	4760-125	
	4760-250	
	4768J-380	
	4770	
	4785	

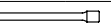

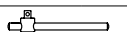
Koken articolo	DESCRIZIONE	
4250M-06	Cassetta metallica 18 Pz. 445 x 190 x h 50 mm	
RICAMBI		
BUSSOLE 	4406M	10, 11, 12, 13, 14, 15, 17, 19, 22, 24, 27, 30, 32
	4753J	
ACCESSORI	4760-125	
	4760-250	
	4770	
	4785	



KOKEN 1/2"

**TOP****ALTA
QUALITÀ
MADE IN JAPAN****ESPOSITORE METALLICO 117 PEZZI CHIAVI A BUSSOLA**

Koken articolo	DESCRIZIONE	TIPO BUSSOLE	NUMERO BUSSOLE	ATTACCO
S 4240M-01	CHIAVI A BUSSOLA ESAGONALI		117 PEZZI	 1/2"
S 4240M-06	CHIAVI A BUSSOLA POLIGONALI		117 PEZZI	 1/2"

CARATTERISTICHE

- espositore metallico: lunghezza 510 mm x larghezza 230 mm x altezza 150 mm
- bussole con attacco quadro femmina 1/2"
- con 117 bussole esagonali così assortite:
 - 9 pezzi, bussole 10 mm
 - 9 pezzi, bussole 11 mm
 - 9 pezzi, bussole 12 mm
 - 9 pezzi, bussole 13 mm
 - 9 pezzi, bussole 14 mm
 - 9 pezzi, bussole 15 mm
 - 9 pezzi, bussole 16 mm
 - 8 pezzi, bussole 17 mm
 - 7 pezzi, bussole 19 mm
 - 7 pezzi, bussole 21 mm
 - 6 pezzi, bussole 22 mm
 - 6 pezzi, bussole 23 mm
 - 6 pezzi, bussole 24 mm
 - 5 pezzi, bussole 27 mm
 - 5 pezzi, bussole 30 mm
 - 4 pezzi, bussole 32 mm



ESAGONO

CHIAVI A BUSSOLA BOCCA ESAGONALE EXTRA CORTE



Koken articolo	mm	D ₁ mm	L mm	
4400MZ-8	8	12.6	26	1
4400MZ-10	10	15	26	1
4400MZ-12	12	17.5	27	1
4400MZ-13	13	18.7	28	1
4400MZ-14	14	19.8	28	1
4400MZ-16	16	22.3	28	1
4400MZ-17	17	23.6	29	1
4400MZ-18	18	24.8	29	1
4400MZ-19	19	26	29	1
4400MZ-21	21	28.4	29	1
4400MZ-22	22	29.6	29	1
4400MZ-24	24	32	29	1
4400MZ-27	27	35.7	30	1
4400MZ-30	30	39.3	31	1
4400MZ-32	32	41.7	32	1



novità

MECCANISMO 72 DENTI



CRICCHETTO PORTABUSSOLA REVERSIBILE

Koken articolo	D mm	T mm	L mm	
4725 Z	36.5	32.8	253	1



novità

MECCANISMO 72 DENTI



CRICCHETTO PORTABUSSOLA REVERSIBILE CON PULSANTE DI SBLOCCAGGIO RAPIDO

Koken articolo	D mm	T mm	L mm	
4725 ZB	36.5	32.8	253	1



novità

QUADRO MASCHIO SNODATO CON IMPUGNATURA

Koken articolo	D mm	L mm	
4768 Z-430	28	430	1



novità

SFERA

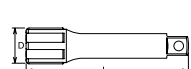

PROLUNGA

Koken articolo	D mm	L mm	
4760 Z-125	23	125	1
4760 Z-250	23	250	1



novità

SFERA



PROLUNGA CON SBLOCCAGGIO RAPIDO

Koken articolo	D1 mm	D2 mm	L mm	
4760 LZ-125	23	20.5	125	1
4760 LZ-250	23	20.5	250	1



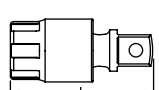

novità

SFERA



SNODO

Koken articolo	L mm	
4771 Z	55.8	1



SFERA

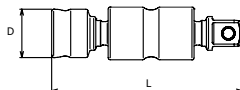

DOPPIO SNODO

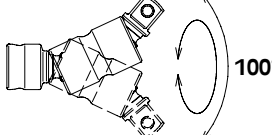

Koken articolo	D mm	L mm	
4772 Z	23.7	87.2	1



NUOVA SERIE Z KO-KEN MADE IN JAPAN

Progettata per soddisfare le crescenti esigenze del settore automotive dove si presentano design di motori più complessi e compatti.

KO-KEN ha studiato questa serie speciale di bussole con lunghezze e diametri ridotti ma mantenendo invariata l'eccellenza dei prodotti Made in Japan

Il design dei cricchetti a 72 denti permette di lavorare in modo efficiente in spazi ristretti e punti difficili da raggiungere senza rinunciare alla capacità di erogare una coppia elevata in spazi ristretti.

BUSSOLE CHROM-VANADIUM - SATINATE

Attacco: 1/2"

impronta: ESAGONO

articolo	mm	L mm	
BGS 2908	8	40	1
BGS 2909	9	40	1
BGS 2910	10	40	1
BGS 2911	11	40	1
BGS 2912	12	40	1
BGS 2913	13	40	1
BGS 2914	14	40	1
BGS 2915	15	40	1
BGS 2916	16	40	1
BGS 2917	17	40	1
BGS 2918	18	40	1
BGS 2919	19	40	1
BGS 2920	20	40	1
BGS 2921	21	40	1
BGS 2922	22	40	1
4615-0230	23	40	1
BGS 2924	24	40	1
4615-0250	25	40	1
BGS 2926	26	45	1
BGS 2927	27	45	1
4615-0280	28	45	1
4615-0290	29	45	1
BGS 2930	30	45	1
BGS 2932	32	45	1
BGS 2934	34	45	1
BGS 2935	35	45	1
BGS 2936	36	45	1
BGS 9845	38	45	1
BGS 2941	41	45	1
BGS 2946-1	46	45	1

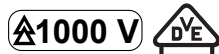
CHIAVI A BUSSOLA A MANO BOCCA ESAGONALI, ATTACCO 1/2"

FEINEC articolo	mm
FM 316-8	8
FM 316-9	9
FM 316-10	10
FM 316-11	11
FM 316-13	13
FM 316-14	14
FM 316-15	15
FM 316-16	16
FM 316-17	17
FM 316-18	18
FM 316-19	19
FM 316-21	21
FM 316-22	22
FM 316-23	23
FM 316-24	24
FM 316-26	26
FM 316-27	27
FM 316-28	28
FM 316-30	30
FM 316-32	32

CARATTERISTICHE

- IEC 60900
- 1000 V



FEINEC articolo	DESCRIZIONE
FM 31032	SET 6 PEZZI, INSERTI ANTI-GRAFFIO PER CHIAVI A BUSSOLA ESAGONALI

CARATTERISTICHE

- inserti speciali che, utilizzati all'interno delle bussole esagonali tradizionali, consentono di prevenire danni a parti cromate o verniciate o, più in generale, con trattamenti superficiali
- comprende:
 - inserto 8 mm, per bussola 12 mm, coppia 9 Nm
 - inserto 10 mm, per bussola 14 mm, coppia 17 Nm
 - inserto 12 mm, per bussola 16 mm, coppia 27 Nm
 - inserto 13 mm, per bussola 17 mm, coppia 45 Nm
 - inserto 15 mm, per bussola 19 mm, coppia 50 Nm
 - inserto 17 mm, per bussola 22 mm, coppia 79 Nm
- per uso con bussole esagonali metriche

BUSSOLE CHROM-VANADIUM POLIGONALI SATINATE

Attacco: 1/2"

impronta: POLIGONALI

articolo	mm	L mm	
BGS 10628	8	40	1
BGS 10629	9	40	1
BGS 10630	10	40	1
BGS 10631	11	40	1
BGS 10632	12	40	1
BGS 10822	12.5 (1/2")	40	1
BGS 10633	13	40	1
BGS 10634	14	40	1
BGS 10635	15	40	1
BGS 10636	16	40	1
BGS 10637	17	40	1
BGS 10638	18	40	1
BGS 10639	19	40	1
BGS 10640	20	40	1
BGS 10641	21	40	1
BGS 10642	22	40	1
BGS 10643	23	40	1
BGS 10644	24	40	1
BGS 10626	26	40	1
BGS 10645	27	40	1
BGS 10625	28	77	1
BGS 10646	30	40	1
BGS 10647	32	40	1
BGS 10648	34	40	1
BGS 10649	36	40	1
BGS 10650-1	41	40	1
BGS 10651-1	46	40	1

POLLICI

BUSSOLE CHROM-VANADIUM - SATINATE IN POLLICI

Attacco: 1/2"

impronta: ESAGONO

articolo	pollici	L mm	
BGS 2770	3/8"	40	1
BGS 2771	7/16"	40	1
BGS 2772	1/2"	40	1
BGS 2773	9/16"	40	1
BGS 2774	5/8"	40	1
BGS 2775	11/16"	40	1
BGS 2776	3/4"	40	1
BGS 2777	13/16"	40	1
BGS 2778	7/8"	40	1
BGS 2779	15/16"	40	1
BGS 2787	1"	40	1
BGS 2784	1 1/16"	40	1
BGS 2788	1 1/8"	40	1
BGS 2786	1 1/4"	40	1



**BUSSOLE CHROM-VANADIUM - SATINATE
SURFACE DRIVE**

Attacco: 1/2"
impronta: SURFACE-DRIVE

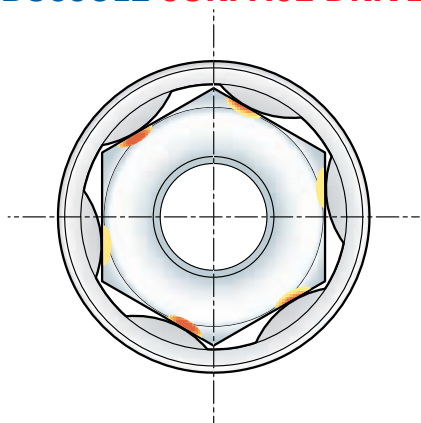

BGS articolo	mm	L mm	
BGS 2408	8	40	1
BGS 2409	9	40	1
BGS 2410	10	40	1
BGS 2411	11	40	1
BGS 2412	12	40	1
BGS 2413	13	40	1
BGS 2414	14	40	1
BGS 2415	15	40	1
BGS 2416	16	40	1
BGS 2417	17	40	1
BGS 2418	18	40	1
BGS 2419	19	40	1
BGS 2420	20	40	1
BGS 2421	21	40	1
BGS 2422	22	40	1
BGS 2423	23	40	1
BGS 2424	24	40	1
BGS 2427	27	45	1
BGS 2428	28	45	1
BGS 2430	30	45	1
BGS 2432	32	45	1

BUSSOLE SURFACE DRIVE



TORX® SATINATE

Attacco: 1/2"
impronta: TORX®

BGS articolo		L mm	
BGS 6460	E 10	40	1
BGS 6461	E 11	40	1
BGS 6462	E 12	40	1
BGS 6464	E 14	40	1
BGS 6466	E 16	40	1
BGS 6418	E 18	40	1
BGS 6420	E 20	40	1
BGS 6422	E 22	40	1
BGS 6424	E 24	40	1

TORX®	S mm	S mm	
E 4	3.70	E 16	14.60
E 5	4.60	E 18	16.50
E 6	5.60	E 20	18.30
E 7	6.10	E 22	20.10
E 8	7.40	E 24	22.00
E 10	9.30	E 26	23.70
E 11	9.90	E 28	25.50
E 12	11.00	E 30	27.30
E 14	12.80	E 32	29.00

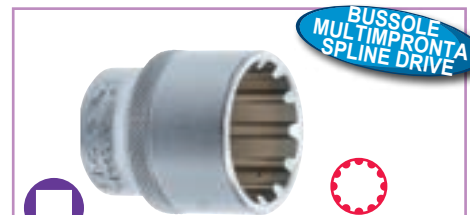

**BUSSOLE MULTIMPRONTA
SPLINE DRIVE**

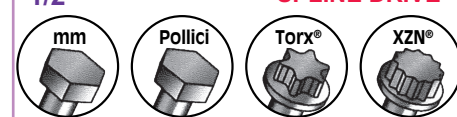



**BUSSOLE CHROM-VANADIUM
MULTIMPRONTA SPLINE-DRIVE**

Attacco: 1/2"
impronta: SPLINE DRIVE

BGS articolo	mm	L mm	
BGS 10208	8	40	1
BGS 10209	9	40	1
BGS 10210	10	40	1
BGS 10211	11	40	1
BGS 10212	12	40	1
BGS 10213	13	40	1
BGS 10214	14	40	1
BGS 10215	15	40	1
BGS 10216	16	40	1
BGS 10217	17	40	1
BGS 10218	18	40	1
BGS 10219	19	40	1
BGS 10220	20	40	1
BGS 10221	21	40	1
BGS 10222	22	40	1
BGS 10224	24	40	1
BGS 10227	27	40	1
BGS 10230	30	45	1
BGS 10232	32	45	1



BUSSOLE TRIANGOLARI

BGS articolo		L mm	
BGS 7460	8	40	1
BGS 7461	10	40	1
BGS 7462	12	40	1
BGS 7463	15	40	1
BGS 7464	16,5	40	1

CARATTERISTICHE

- finitura cromata satinata
- zigrinate
- attacco quadro da 1/2"
- idonee per adattatore pompa iniettore VAG TDI, Iniettori Bosch, quadri di comando e barriere



1/2"

BGS
articolo

DESCRIZIONE

BGS 8608

**SERIE 5 PEZZI,
BUSSOLE
TRIANGOLARI,
M5 - M12 (8 - 16,5 MM),
ATT. 1/2"**

CARATTERISTICHE

- Set bussole a triangolari: M5 - M6 - M8 - M10 - M12
- finitura cromata satinata
- zigrinate
- attacco quadro da 1/2"
- idonee per adattatore pompa iniettore VAG TDI, Iniettori Bosch, quadri di comando e barriere
- peso: 440 g

BGS
articolo

DESCRIZIONE

BGS 9106

**SERIE 11 PEZZI,
BUSSOLE
ESAGONALI 10-21 MM,
ATT. 1/2"**

CARATTERISTICHE

- misure: 10 - 11 - 12 - 13 - 14 - 15 - 16 - 17 - 18 - 19 - 21 mm
- finitura cromata satinata
- zigrinate
- su guida metallica
- peso: 760 g

BGS
articolo

DESCRIZIONE

BGS 9108

**SERIE 7 PEZZI,
BUSSOLE
ESAGONALI 20-32 MM,
ATT. 1/2"**

CARATTERISTICHE

- misure: 20 - 21 - 22 - 24 - 27 - 30 - 32 mm
- finitura cromata satinata
- zigrinate
- su guida metallica
- peso: 1,0 kg

POLLICI

BGS
articolo

DESCRIZIONE

BGS 9113

**SERIE 10 PEZZI,
BUSSOLE
ESAGONALI IN POLLICI
3/8" - 15/16", ATT. 1/2"**

CARATTERISTICHE

- misure: 3/8" - 7/16" - 1/2" - 9/16" - 5/8" - 11/16" - 3/4" - 13/16" - 7/8" - 15/16"
- finitura cromata satinata, zigrinate
- su guida metallica
- peso: 750 g

BGS
articolo

DESCRIZIONE

BGS 9107

**SERIE 11 PEZZI,
BUSSOLE
POLIGONALI 10-21 MM,
ATT. 1/2"**

CARATTERISTICHE

- misure: 10 - 11 - 12 - 13 - 14 - 15 - 16 - 17 - 18 - 19 - 21 mm
- finitura cromata satinata
- zigrinate
- su guida metallica
- peso: 700 g

BGS
articolo

DESCRIZIONE

BGS 9109

**SERIE 7 PEZZI,
BUSSOLE
POLIGONALI 20-32 MM,
ATT. 1/2"**

CARATTERISTICHE

- misure: 20 - 21 - 22 - 24 - 27 - 30 - 32 mm
- finitura cromata satinata, zigrinate
- su guida metallica
- peso: 980 g

BGS
articolo

DESCRIZIONE

BGS 70102

**SERIE 6 PEZZI,
BUSSOLE POLIGONALI,
24-38 MM, ATT. 1/2"**

CARATTERISTICHE

- zigrinate
- su guida metallica
- profilo di azionamento: quadrato interno
- attacco quadro femmina: 1/2"
- poligonali
- finitura cromata satinata
- comprende:
 - 1 bussola poligonale, 24 mm (BGS 10644)
 - 1 bussola poligonale, 30 mm (BGS 10646)
 - 1 bussola poligonale, 32 mm (BGS 10647)
 - 1 bussola poligonale, 35 mm
 - 1 bussola poligonale, 36 mm (BGS 10649)
 - 1 bussola poligonale, 38 mm
- peso: 1,5 kg

BGS
articolo

DESCRIZIONE

BGS 9114

**SERIE 10 PEZZI,
BUSSOLE
POLIGONALI IN POLLICI
3/8" - 15/16", ATT. 1/2"**

CARATTERISTICHE

- misure: 3/8" - 7/16" - 1/2" - 9/16" - 5/8" - 11/16" - 3/4" - 13/16" - 7/8" - 15/16"
- finitura cromata satinata, zigrinate
- su guida metallica
- peso: 720 g

BGS
articolo

DESCRIZIONE

BGS 8806

**SERIE 8 PEZZI,
BUSSOLE TORX PLUS
18-32 EP, ATT. 1/2"**

CARATTERISTICHE

- nuova impronta Torx Plus
- angolo d'applicazione è di 0 gradi, rispetto i 15 gradi dell'impronta Torx tradizionale
- misure: 18EP - 20EP - 22EP - 24EP - 26EP - 28EP - 30EP - 32EP
- finitura cromata lucida
- su guida metallica
- utilizzo settore automotive e veicoli industriali
- peso: 1,0 kg



BGS articolo	DESCRIZIONE
BGS 9131	SET 19 PEZZI, BUSSOLE, ESAGONALI, ATT. 1/2", 8 - 32 MM

CARATTERISTICHE	
<ul style="list-style-type: none"> • per uso a mano • zigrinate • in cassetta in plastica • attacco quadro 1/2" • impronta: Esagonale • materiale: acciaio al cromo vanadio • finitura: cromata satinata • comprende: <ul style="list-style-type: none"> 8 mm (BGS 2908) - 9 mm (BGS 2909) 10 mm (BGS 2910) - 11 mm (BGS 2911) 12 mm (BGS 2912) - 13 mm (BGS 2913) 14 mm (BGS 2914) - 15 mm (BGS 2915) 16 mm (BGS 2916) - 17 mm (BGS 2917) 18 mm (BGS 2918) - 19 mm (BGS 2919) 20 mm (BGS 2920) - 21 mm (BGS 2921) 22 mm (BGS 2922) - 24 mm (BGS 2924) 27 mm (BGS 2927) - 30 mm (BGS 2930) 32 mm (BGS 2932) • peso 2,8 kg 	



BGS articolo	DESCRIZIONE
BGS 2246	SET 23 PEZZI, BUSSOLE ESAGONALI IN POLLICI, ATT. 1/4" - 1/2"

CARATTERISTICHE	
<ul style="list-style-type: none"> • bussole esagonali attacco 1/4": 5/32", 3/16", 7/32", 1/4", 9/32", 5/16", 11/32", 3/8", 7/16", 15/32" • bussole esagonali attacco 1/2": 1/2", 9/16", 19/32", 5/8", 11/16", 3/4", 13/16", 7/8", 15/16", 1", 1-1/16", 1-1/8", 1-1/4" • finitura satinata cromata • zigrinate • peso: 2,2 kg 	



BGS articolo	DESCRIZIONE
BGS 2434	SET 10 PEZZI, BUSSOLE IN POLLICI, ATT. 1/2"

CARATTERISTICHE	
<ul style="list-style-type: none"> • esagonali • 3/8", 7/16", 1/2", 9/16", 5/8", 11/16", 3/4", 13/16", 7/8", 15/16" • finitura cromata satinata • peso: 910 g 	

RICAMBI	
BGS articolo	DESCRIZIONE
BGS 2434-LEER	CASSETTA VUOTA



BGS articolo	DESCRIZIONE
BGS 2226	SET 16 PEZZI, BUSSOLE POLIGONALI 8-24 MM FINITURA CROMATA SATINATA, ATT. 1/2"

CARATTERISTICHE	
<ul style="list-style-type: none"> • misure: 8 - 9 - 10 - 11 - 12 - 13 - 14 - 15 - 16 - 17 - 18 - 19 - 20 - 21 - 22 - 24 mm • peso: 1,3 kg 	



BGS articolo	DESCRIZIONE
BGS 2267	SET 21 PEZZI, BUSSOLE POLIGONALI 8-36 MM, ATT. 1/2"

CARATTERISTICHE	
<ul style="list-style-type: none"> • misure: 8 - 9 - 10 - 11 - 12 - 13 - 14 - 15 - 16 - 17 - 18 - 19 - 20 - 21 - 22 - 24 - 27 - 30 - 32 - 34 - 36 mm • peso: 2,8 kg 	

1/2"



BUSSOLE MULTIMPRONTA SPLINE DRIVE

1/2" MULTIMPRONTA SPLINE DRIVE CV PRO+

BGS articolo	DESCRIZIONE
BGS 2152	SET 19 PEZZI, BUSSOLE "MULTIMPRONTA", ATT. 1/2"

- CARATTERISTICHE**
- lo speciale profilo "multimpronta" consente l'uso universale con misure a esagono, poligonale, Torx, metrico e pollici
 - 8 - 9 - 10 - 11 - 12 - 13 - 14 - 15 - 16 - 17 - 18 - 19 - 20 - 21 - 22 - 24 - 27 - 30 - 32 mm
 - anche per bussole Torx (E10, E12, E14, E16, E18, E20, E22, E24), e misure in pollici (5/16", 11/32", 3/8", 7/16", 15/32", 1/2", 9/16", 19/32", 5/8", 3/4", 25/32", 13/16", 7/8", 15/16", 1-1/16", 1-3/16", 1-1/4")
 - per bussole con esagono e poligonale
 - peso: 2,0 kg

RICAMBI

BGS articolo	DESCRIZIONE
BGS 2152-LEER	CASSETTA VUOTA



1/2" TORX CV PRO+

BGS articolo	DESCRIZIONE
BGS 6425	SET 9 PEZZI, BUSSOLE TORX, ATT. 1/2"

- CARATTERISTICHE**
- E10-11-12-14-16-18-20-22-24
 - finitura satinata cromata
 - peso: 860 g

TORX®	S mm	S mm	
E 4	3.70	E 16	14.60
E 5	4.60	E 18	16.50
E 6	5.60	E 20	18.30
E 7	6.10	E 22	20.10
E 8	7.40	E 24	22.00
E 10	9.30	E 26	23.70
E 11	9.90	E 28	25.50
E 12	11.00	E 30	27.30
E 14	12.80	E 32	29.00



1/4" 3/8" 1/2" TORX PRO+

BGS articolo	DESCRIZIONE
BGS 70099	SET 28 PEZZI, BUSSOLE TORX FEMMINA, E4 - E24, ATT. 1/4" - 3/8" - 1/2"

- CARATTERISTICHE**
- zigrinato
 - finitura cromata satinata
 - impronta Torx Femmina
 - comprende:
 - attacco 1/4": E4 - E5 - E6 - E7 - E8 - E10 - E11
 - attacco 3/8": E4 - E5 - E6 - E7 - E8 - E8 - E10 - E11 E12 - E14 - E16 - E18 - E20
 - attacco 1/2": E4 - E5 - E6 - E7 - E8 - E8 - E10 - E10 E11 - E12 - E12 - E14 - E16 - E18 - E20
 - peso: 1,3 kg



1/2" TORX TORX CON FORO PRO+ CV

BGS articolo	DESCRIZIONE
BGS 5101	SET 27 PEZZI, INSERTI E CHIAVI A BUSSOLA TORX, ATT. 1/2"

- CARATTERISTICHE**
- conformi DIN
 - 5 chiavi a bussola attacco da 1/2" T45-50-55-60-70
 - 7 inserti per viti Torx Tx10-15-20-25-27-30-40
 - 12 inserti Torx c/foro: Th10-15-20-25-27-30-40-45 50-55-60-70
 - 3 adattatori per inserti attacco da 1/4" - 3/8" - 1/2"
 - peso: 960 g



1/2"



FERMEC



EPR 5 PT TORXplus TESLA

PER TESLA

articolo	DESCRIZIONE
FM 16 EPR	SET 16 PEZZI, BUSSOLE TORX PLUS EPR 5 PT, 6 EPR - 32 EPR, ATT. 1/4" - 3/8" - 1/2"

CARATTERISTICHE

- zigrinato
- finitura cromata satinata
- impronta Torx Plus EPR 5 PT
- per Tesla
- comprende:
 - attacco 1/4", lunghezza 25 mm: 6 EPR - 7 EPR - 8 EPR - 10 EPR - 11 EPR
 - attacco 3/8", lunghezza 37 mm: 12 EPR - 14 EPR - 16 EPR - 18 EPR - 20 EPR
 - attacco 1/2", lunghezza 45 mm: 22 EPR - 24 EPR - 26 EPR - 28 EPR - 30 EPR - 32 EPR





1/2"  **ESAGONO**

BUSSOLE CHROM-VANADIUM SATINATE LUNGHE ESAGONO INTERNO PROFONDO

Attacco: 1/2"
impronta: ESAGONO

BGS articolo	mm	L mm	
BGS 9355	8	77	1
BGS 10550	10	77	1
BGS 10551	11	77	1
BGS 10552	12	77	1
BGS 10553	13	77	1
BGS 10554	14	77	1
BGS 10555	15	77	1
BGS 10556	16	77	1
BGS 10557	17	77	1
BGS 10558	18	77	1
BGS 10559	19	77	1
BGS 10560	20	77	1
BGS 10561	21	77	1
BGS 10562	22	77	1
BGS 10563	23	77	1
BGS 10564	24	77	1
BGS 10566	26	77	1
BGS 10567	27	77	1
BGS 10568	28	77	1
BGS 10570	30	77	1
BGS 10572	32	77	1
BGS 9846	38	77	1





1/2"   **POLIGONALE**

BUSSOLE CHROM-VANADIUM POLIGONALI LUNGHE - SATINATE

Attacco: 1/2"
impronta: POLIGONALI

BGS articolo	mm	L mm	
BGS 9356	8	77	1
BGS 10680	10	77	1
BGS 9357	11	77	1
BGS 10662	12	77	1
BGS 10681	13	77	1
BGS 10664	14	77	1
BGS 10682	15	77	1
BGS 10683	16	77	1
BGS 10684	17	77	1
BGS 10685	18	77	1
BGS 10686	19	77	1
BGS 9359	20	77	1
BGS 9360	21	77	1
BGS 10687	22	77	1
BGS 10688	24	77	1
BGS 10663	26	77	1
BGS 9363	27	77	1
BGS 10689	28	77	1



1/2"   **SURFACE DRIVE**

BUSSOLE CHROM-VANADIUM - SATINATE LUNGHE - SURFACE DRIVE

Attacco: 1/2"
impronta: SURFACE-DRIVE

BGS articolo	mm	L mm	
BGS 10268	8	77	1
BGS 10270	10	77	1
BGS 10271	11	77	1
BGS 10272	12	77	1
BGS 2943	13	77	1
BGS 2944	14	77	1
BGS 2945	15	77	1
BGS 2946	16	77	1
BGS 2947	17	77	1
BGS 2948	18	77	1
BGS 2949	19	77	1
BGS 2951	21	77	1
BGS 2952	22	77	1
BGS 9361	24	77	1
BGS 9362	27	77	1
BGS 2956	28	77	1

BUSSOLE SURFACE DRIVE

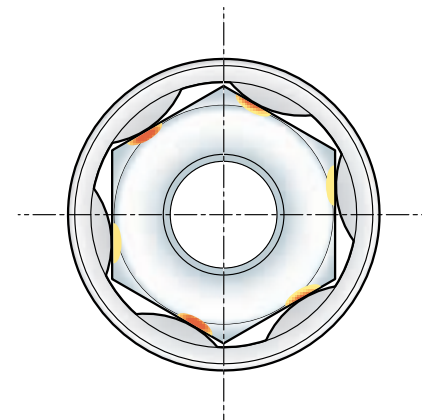

1/2"

novità



BUSSOLE ISOLATE VDE, ESAGONALI, ATT. 1/2"

BGS articolo	mm	L mm
BGS 72060	10	92
BGS 72061	11	92
BGS 72062	12	92
BGS 72063	13	92
BGS 72064	14	92
BGS 72066	16	92
BGS 72067	17	92
BGS 72068	18	92
BGS 72069	19	92
BGS 72072	22	92
BGS 72074	24	92
BGS 72077	27	94
BGS 72080	30	94
BGS 72082	32	94

CARATTERISTICHE

- perfette per l'utilizzo su impianti elettrici o per i lavori di riparazione e manutenzione di veicoli ibridi ed elettrici
- riducono il rischio di cortocircuiti
- perfette per elettricisti e specialisti del settore elettrico
- isolate VDE fino a 1000 V, secondo EN 60900/IEC 60900
- impronta: Esagonale
- attacco quadro: 1/2"
- materiale: acciaio al cromo vanadio
- finitura: isolata
- DIN: EN/IEC 60900

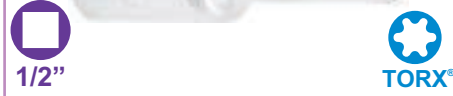

TORX® LUNGHE SATINATE

Attacco: 1/2"
impronta: TORX®

BGS articolo	E	L mm	mm
BGS 6440	E 10	77	1
482-1177	E 11	77	1
BGS 6442	E 12	77	1
BGS 6444	E 14	77	1
BGS 6446	E 16	77	1
BGS 6448	E 18	77	1
BGS 6450	E 20	77	1

TORX®

	S mm	S mm	
E 4	3.70	E 16	14.60
E 5	4.60	E 18	16.50
E 6	5.60	E 20	18.30
E 7	6.10	E 22	20.10
E 8	7.40	E 24	22.00
E 10	9.30	E 26	23.70
E 11	9.90	E 28	25.50
E 12	11.00	E 30	27.30
E 14	12.80	E 32	29.00

BUSSOLE MULTIMPRONTA SPLINE DRIVE



BUSSOLE CHROM-VANADIUM MULTIMPRONTA SPLINE-DRIVE

Attacco: 1/2"
impronta: SPLINE DRIVE

BGS articolo	mm	L mm	mm
BGS 10254	14	77	1
BGS 10255	15	77	1
BGS 10256	16	77	1
BGS 10257	17	77	1
BGS 10258	18	77	1
BGS 10259	19	77	1

MILIMETRI E POLLICI



BUSSOLA UNIVERSALE

BGS articolo	PER MISURE	mm
BGS 2533	3/8"	9-19 MM
BGS 2531	1/2"	11-30 MM
BGS 2833	3/4"	12-38 MM

CARATTERISTICHE

- adatta a tutte le impronte esagonali anche in pollici
- i perni a molla consentono un perfetto adattamento sulla maggior parte dei dadi, viti, viti a gancio, dadi ad alette e gommini



BGS articolo	DESCRIZIONE
BGS 2223	SERIE 9 PEZZI, BUSSOLE ESAGONALI, TIPO LUNGO, ATT. 1/2"

CARATTERISTICHE

- finitura satinata cromata, zigrinata
- esagonali
- misure: 10-13-15-16-17-18-19-22-24 mm
- peso: 1,3 kg



BGS articolo	DESCRIZIONE
BGS 5253	SERIE 9 PEZZI, BUSSOLE POLIGONALI, TIPO LUNGO, ATT. 1/2"

CARATTERISTICHE

- misure: 10 - 13 - 15 - 16 - 17 - 18 - 19 - 22 - 24 mm
- finitura satinata cromata
- zigrinate
- con supporto in plastica
- peso: 1,3 kg



POLLICI



1/2"



ESAGONO



CV

PRO+

BGS
articolo

DESCRIZIONE

BGS 2435

**SERIE 10 PEZZI,
BUSSOLE ESAGONALI
IN POLLICI,
TIPO LUNGO, ATT. 1/2"**

CARATTERISTICHE

- finitura esagonale
- 3/8", 7/16", 1/2", 9/16", 5/8", 11/16", 3/4", 13/16", 7/8", 15/16"
- finitura satinata cromata
- peso: 1,4 kg



1/2"



TORX®



CV

PRO+

BGS
articolo

DESCRIZIONE

BGS 2026

**SERIE 9 PEZZI,
BUSSOLE TORX, TIPO
LUNGO, ATT. 1/2"**

CARATTERISTICHE

- finitura satinata cromata
- zigrinate
- Torx (lung. circa 80 mm) E 10 - 11 - 12 - 14 - 16 - 18 - 20 - 22 - 24
- peso: 1,3 kg



1/2"



PRO+

CHIAVI APERTE A ZAMPA DI GALLO

attacco: 1/2"

BGS articolo	mm	
BGS 1757-20	20	1
BGS 1757-21	21	1
BGS 1757-22	22	1
BGS 1757-23	23	1
BGS 1757-24	24	1
BGS 1757-25	25	1
BGS 1757-26	26	1
BGS 1757-27	27	1
BGS 1757-28	28	1
BGS 1757-30	30	1
BGS 1757-32	32	1
BGS 1759-33	33	1
BGS 1759-36	36	1



1/2"

PRO+

BGS
articolo

DESCRIZIONE

BGS 1757

**SET 13 PEZZI,
CHIAVI APERTE A
ZAMPA DI GALLO,
20-32 MM,
ATT. 1/2"**

CARATTERISTICHE

- comprende:
 - chiavi aperte a zampa di gallo att. 1/2": 20, 21, 22, 23, 24, 25, 26, 27, 28, 30, 32, mm
 - 1 prolunga att. 1/2" lunghezza 125 mm
 - 1 impugnatura con quadro snodato att. 1/2", lunghezza 385 mm
- peso: 3,5 kg

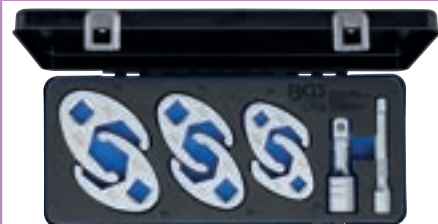

1/2"



3/4"

PRO+

BGS
articolo

DESCRIZIONE

BGS 1759

**SET 8 PEZZI,
CHIAVI APERTE A
ZAMPA DI GALLO,
33-50 MM,
ATT. 1/2" - 3/4"**

CARATTERISTICHE

- comprende:
 - chiavi aperte a zampa di gallo:
 - 33, 36 mm, attacco 1/2"
 - 38, 41, 46, 50 mm, attacco 3/4"
 - 1 prolunga att. 1/2" lunghezza 125 mm
 - 1 prolunga att. 3/4" lunghezza 100 mm
- peso: 4,1 kg



1/2"

PRO+



OPEL

**CHIAVE PER REGOLAZIONE POMPA
DELL'ACQUA PER OPEL**

BGS
articolo

DESCRIZIONE

BGS 8971

39 MM

BGS 8972

41 MM

BGS 8973

46 MM

CARATTERISTICHE

- per ruotare la pompa dell'acqua, durante la regolazione della tensione della cinghia dentata
- per motori a benzina di Opel OHC come, ad esempio, 1.2-1.3-1.4-1.6 l
- attacco quadro: 1/2 "

1/2"



CHIAVI A BUSSOLA MASCHIO ESAGONALI

 Attacco: 1/2"
 impronta: ESAGONO

FEIMEC articolo	mm	L mm	
BGS 4250	4	55	1
BGS 4251	5	55	1
BGS 9467	5,5	55	1
BGS 4252	6	55	1
BGS 4253	7	55	1
BGS 4254	8	55	1
BGS 4340	9	55	1
BGS 4255	10	55	1
BGS 4256	12	55	1
455-1355	13	55	1
BGS 4257	14	55	1
BGS 5184-H17	17	55	1
BGS 5184-H19	19	55	1
BGS 5184-H22	22	55	1
BGS 5184-H24	24	55	1
BGS 5184-H26	26	55	1
<hr/>			
BGS 5052-14	14	70	1
BGS 5052-16	16	70	1
BGS 5052-17	17	70	1
BGS 5052-18	18	70	1
BGS 5052-19	19	70	1
BGS 4295	22	70	1
<hr/>			
BGS 4259	4	100	1
BGS 4260	5	100	1
BGS 4261	6	100	1
BGS 4262	7	100	1
BGS 4263	8	100	1
BGS 4268	9	100	1
BGS 4264	10	100	1
BGS 4266	11	100	1
BGS 4265	12	100	1
BGS 4267	13	100	1
BGS 4296	14	100	1
<hr/>			
BGS 4270	5	140	1
BGS 4271	6	140	1
BGS 4217	7	140	1
BGS 4272	8	140	1
BGS 5184-H10	10	140	1
BGS 5184-H11	11	140	1
BGS 4273	12	140	1
BGS 5184-H13	13	140	1
BGS 4274	14	140	1
<hr/>			
BGS 4275	5	200	1
BGS 4276	6	200	1
BGS 4277	7	200	1
BGS 4278	8	200	1
BGS 4279	10	200	1
BGS 4280	12	200	1
<hr/>			
BGS 4215	5	240	1
BGS 4216	6	240	1
BGS 5184-H7	7	230	1
BGS 4218	8	240	1
<hr/>			
BGS 74360	6	350	1



**CHIAVI A BUSSOLA MASCHIO ESAGONALI
TESTA SFERICA**

 Attacco: 1/2"
 impronta: ESAGONO

FEIMEC articolo	mm	L mm	
459-0510	5	100	1
459-0610	6	100	1
459-0810	8	100	1
459-1010	10	100	1
<hr/>			
BGS 4258-5	5	140	1
BGS 4258-6	6	140	1
BGS 4258-7	7	140	1
BGS 4258-8	8	140	1
BGS 4258-10	10	140	1
BGS 4258-12	12	140	1
<hr/>			
BGS 5184-HB5	5	160	1

MISURE IN POLLICI

 Attacco: 1/2"
 impronta: ESAGONO

BGS articolo	pollici	L mm	
40902-5/32	5/32"	55	1
40902-3/16	3/16"	55	1
BGS 2732	7/32"	55	1
BGS 2733	1/4"	55	1
BGS 2734	9/32"	55	1
BGS 2735	5/16"	55	1
BGS 2736	3/8"	55	1
40902-7/16	7/16"	55	1
BGS 2737	15/32"	70	1
40902-1/2	1/2"	55	1
BGS 2738	9/16"	70	1
BGS 2751	5/8"	70	1
BGS 2752	11/16"	70	1
BGS 2753	13/16"	70	1
BGS 2754	3/4"	70	1



1/2" 22 mm TORX®



BGS articolo	DESCRIZIONE
BGS 9532	BUSSOLA PER CINGHIE A V. ATT. 1/2", TORX TX60

CARATTERISTICHE

- bussola speciale per motori TDI common rail VAG 6 cilindri per il rilascio della cinghia a V
- per uso come OEM T40087
- manovra:
 - quadro femmina: 1/2"
 - esagono: 22 mm
- peso: 80 g

TORX®	S mm	S mm	
T 6	1.70	T 40	6.70
T 7	2.00	T 45	7.90
T 8	2.30	T 50	8.90
T 9	2.50	T 55	11.30
T 10	2.70	T 60	13.30
T 15	3.30	T 70	15.60
T 20	3.90	T 80	17.60
T 25	4.50	T 90	20.00
T 27	5.00	T 100	22.20
T 30	5.60		



1/2" PRO+ CV

BGS articolo	DESCRIZIONE
BGS 9386	BUSSOLA MASCHIO, ATT. 1/2", PER POLYDRIVE, T52 X 168 MM



CARATTERISTICHE

- impronta speciale per viti VAG
- per uso come OEM T10070
- zigrinata
- finitura satinata cromata
- peso: 200 g



CHIAVI A BUSSOLA TORX®



Attacco: 1/2"
impronta: TORX®

FEIMEC articolo		L mm	
BGS 4368	TX 15	55	1
BGS 4369	TX 20	55	1
BGS 4370	TX 25	55	1
BGS 4367	TX 27	55	1
BGS 4371	TX 30	55	1
BGS 9627	TX 35	55	1
BGS 4372	TX 40	55	1
BGS 4373	TX 45	55	1
721047 IMPACT	TX 47	55	1
BGS 4374	TX 50	55	1
BGS 4375	TX 55	55	1
BGS 4378	TX 60	55	1
BGS 4379	TX 70	55	1
BGS 4468	TX 15	100	1
BGS 4469	TX 20	100	1
BGS 4470	TX 25	100	1
BGS 4467	TX 27	100	1
BGS 4471	TX 30	100	1
BGS 9628	TX 35	100	1
BGS 4472	TX 40	100	1
BGS 4473	TX 45	100	1
BGS 4474	TX 50	100	1
BGS 4475	TX 55	100	1
BGS 4476	TX 60	100	1
BGS 4477	TX 70	100	1
4705-8010	TX 80	100	1
4705-9010	TX 90	100	1
4705-10010	TX 100	100	1
BGS 9364	TX 25	140	1
BGS 9348	TX 27	140	1
BGS 5184-T30	TX 30	140	1
BGS 5184-T40	TX 40	140	1
BGS 5184-T45	TX 45	140	1
BGS 5184-T50	TX 50	140	1
BGS 5184-T55	TX 55	140	1
BGS 5184-T60	TX 60	140	1
BGS 5184-T70	TX 70	140	1
471-8014	TX 80	140	1
471-9014	TX 90	140	1
471-10014	TX 100	140	1
BGS 9365	TX 25	200	1
BGS 4479	TX 30	200	1
BGS 4480	TX 40	200	1
BGS 4481	TX 45	200	1
BGS 4482	TX 50	200	1
BGS 4483	TX 55	200	1
BGS 4484	TX 60	200	1
BGS 4485	TX 70	200	1



CHIAVI A BUSSOLA TORX® C/FORO



Attacco: 1/2"
impronta: TORX® C/FORO

FEIMEC articolo		L mm	
472-2055	TH 20	55	1
472-2555	TH 25	55	1
472-2755	TH 27	55	1
472-3055	TH 30	55	1
BGS 4326	TH 40	55	1
BGS 4327	TH 45	55	1
BGS 4328	TH 50	55	1
BGS 4329	TH 55	55	1
BGS 4376	TH 60	55	1
BGS 4377	TH 70	55	1
473-2010	TH 20	100	1
473-2510	TH 25	100	1
473-2710	TH 27	100	1
473-3010	TH 30	100	1
473-4010	TH 40	100	1
473-4510	TH 45	100	1
473-5010	TH 50	100	1
473-5510	TH 55	100	1
473-6010	TH 60	100	1
473-7010	TH 70	100	1
BGS 5184-TB80	TH 80	100	1
473-9010	TH 90	100	1
473-10010	TH 100	100	1
BGS 5103-TB70	TH 70	110	1
BGS 5103-TB80	TH 80	110	1
BGS 5103-TB90	TH 90	110	1
BGS 5103-TB100	TH 100	110	1
474-4014	TH 40	140	1
474-4514	TH 45	140	1
474-5014	TH 50	140	1
474-5514	TH 55	140	1
474-6014	TH 60	140	1
474-7014	TH 70	140	1
474-8014	TH 80	140	1
474-9014	TH 90	140	1
474-10014	TH 100	140	1
4742-4020	TH 40	200	1
4742-4520	TH 45	200	1
4742-5020	TH 50	200	1
BGS 5184-TB30	TH 30	300	1



CHIAVI A BUSSOLA RIBE®

Attacco: 1/2"
impronta: RIBE®

FEIMEC articolo		L mm	
BGS 4150	M 5	55	1
BGS 4151	M 6	55	1
BGS 4152	M 7	55	1
BGS 4153	M 8	55	1
BGS 4154	M 9	55	1
BGS 4155	M 10	55	1
BGS 9353	M 10.3	55	1
BGS 4156	M 12	55	1
BGS 4157	M 13	55	1
BGS 4158	M 14	55	1
4782-0016	M 16	63	1
4782-0018	M 18	63	1
4782-0020	M 20	63	1
BGS 4160	M 5	100	1
BGS 4161	M 6	100	1
BGS 4162	M 7	100	1
BGS 4163	M 8	100	1
BGS 5184-R9	M 9	100	1
BGS 4165	M 10	100	1
BGS 4166	M 12	100	1
BGS 4167	M 13	100	1
BGS 4168	M 14	100	1
4784-0016	M 16	100	1
BGS 4234	M 7	140	1
BGS 4173	M 8	140	1
BGS 4174	M 9	140	1
BGS 5184-R10	M 10	140	1
BGS 4179	M 10.3	140	1
BGS 4176	M 12	140	1
BGS 4177	M 13	140	1
BGS 4178	M 14	140	1
4788-0007	M 7	000	1
BGS 4183	M 8	200	1
BGS 4184	M 9	200	1
BGS 4185	M 10	200	1
BGS 4189	M 10.3	200	1
BGS 4186	M 12	200	1
BGS 4187	M 13	200	1
BGS 4188	M 14	200	1
BGS 5184-R7	M 7	240	1
BGS 5184-R8	M 8	240	1

RIBE

	S mm	W mm
M 5	5.00	1.20
M 6	6.00	1.30
M 7	7.00	1.40
M 8	8.00	1.80
M 9	9.00	2.00
M 10	10.00	2.30
M 12	12.00	2.60
M 13	13.00	3.10
M 14	14.00	3.20
M 16	16.00	3.60

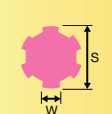

1/2"



1/2"

RIBE
CON FORO
CHIAVI A BUSSOLA RIBE® C/FORO

Attacco: 1/2"

impronta: RIBE® C/FORO

FEARMEC articolo	M	L mm	
4783-0005	M 5	63	1
4783-0006	M 6	63	1
4783-0007	M 7	63	1
4783-0008	M 8	63	1
4783-0009	M 9	63	1
4783-0010	M 10	63	1
4783-0012	M 12	63	1
4783-0013	M 13	63	1
4783-0014	M 14	63	1
4783-0016	M 16	63	1
4785-0005	M 5	100	1
4785-0006	M 6	100	1
4785-0007	M 7	100	1
4785-0008	M 8	100	1
4785-0009	M 9	100	1
4785-0010	M 10	100	1
4785-0012	M 12	100	1
4785-0013	M 13	100	1
4785-0014	M 14	100	1
4785-0016	M 16	100	1



1/2"

XZN
CON FORO
CHIAVI A BUSSOLA XZN® CON FORO

Attacco: 1/2"

impronta: XZN® CON FORO

FEARMEC articolo	M	L mm	
4751-1455	M 14	55	1
BGS 4356	M 16	55	1
BGS 4357	M 16	100	1
BGS 4365	M 18	100	1



1/2"



XZN

CHIAVI A BUSSOLA XZN®

Attacco: 1/2"

impronta: XZN®

FEARMEC articolo	M	L mm	
BGS 4350	M 5	55	1
BGS 4351	M 6	55	1
BGS 4355	M 7	55	1
BGS 4352	M 8	55	1
BGS 4349	M 9	55	1
BGS 4353	M 10	55	1
BGS 4354	M 12	55	1
BGS 4344	M 14	55	1
BGS 4346	M 16	55	1
BGS 5180-M17	M 17	55	1
BGS 4347	M 18	55	1
BGS 4359	M 5	100	1
BGS 4360	M 6	100	1
BGS 4432	M 7	100	1
BGS 4361	M 8	100	1
BGS 5184-M9	M 9	100	1
BGS 4362	M 10	100	1
BGS 4363	M 12	100	1
BGS 4364	M 14	100	1
BGS 5184-M18	M 18 BRUNITA	78	1
BGS 4330	M 5	140	1
BGS 4331	M 6	140	1
BGS 4432	M 7	140	1
BGS 4332	M 8	140	1
BGS 4333	M 9	140	1
BGS 5184-M10	M 10	140	1
BGS 5184-M12	M 12	140	1
BGS 5184-M14	M 14	140	1
BGS 4334	M 8	200	1
BGS 4335	M 10	200	1
BGS 4336	M 12	200	1
BGS 4337	M 14	200	1
BGS 4227	M 8	800	1
BGS 4228	M 10	800	1
BGS 4229	M 12	800	1
BGS 4233	M 14	800	1

novità



XZN 1/2"

PRO+

BGS 74588

BGS 74589

BGS
articolo

DESCRIZIONE

BGS 74590

SET 2 PEZZI, CHIAVI
A BUSSOLA SPECIALI
PER VAG,
ATTACCO 1/2",
XZN M12

CARATTERISTICHE

- per sbloccare il collegamento a vite del cuscinetto della ruota nell'alloggiamento in alluminio con l'albero di trasmissione installato
- design extra sottile
- albero conico per spazi di installazione ristretti
- adatto ai puntoni a molla McPherson
- per uso a mano
- impronta: XZN
- misura: M12
- attacco quadro: 1/2"
- finitura: fosfatata
- materiale: acciaio al cromo molibdeno
- comprende:
 - 1 chiave a bussola speciale, lunghezza 115 mm, att. 1/2", XZN M12, per VAG (BGS 74588)
 - 1 chiave a bussola speciale, lunghezza 72 mm, att. 1/2", XZN M12, per VAG (BGS 74589)
- peso: 290 g

RICAMBI

BGS
articolo

DESCRIZIONE

BGS 74588

XNZ M12,
LUNGHEZZA: 115 MM

BGS 74589

XNZ M12,
LUNGHEZZA: 72 MM

XZN

S
mmS
mm

M 4	3,60	M12	11,50
M 5	4,80	M14	13,30
M 6	6,10	M16	15,70
M 8	7,30	M18	16,90
M10	9,70		



 1/2" **PRO+**

BGS articolo	DESCRIZIONE
BGS 4095-2	ESPOSITORE VUOTO, PER LA VENDITA PER BUSSOLE & CHIAVI A BUSSOLA, ATTACCO 1/2"

CARATTERISTICHE

- con lo spazio per 315 bussole e chiavi a bussola con maschio con attacco 1/2"
- con modulo in EPE nel vano superiore
- dimensioni (Profondità x Larghezza x Altezza): 335 x 410 x 270 mm
- peso: 6,4 kg



POLLICI
 1/2" **ESAGONO** **PRO+** **CV**

BGS articolo	DESCRIZIONE
BGS 5053	SET 12 PEZZI, CHIAVI A BUSSOLA ESAGONALI IN POLLICI, ATT. 1/2"

CARATTERISTICHE

- comprende:
 - bussole lungh. 55 mm: 7/32" - 1/4" - 9/32" - 5/16" - 3/8" - 15/32"
 - bussole lungh. 70 mm: 9/16" - 5/8" - 11/16" - 13/16" - 3/4"
- finitura satinata cromata
- zigrinate
- peso: 1,8 kg

RICAMBI

BGS articolo	DESCRIZIONE
BGS 2732	7/32"
BGS 2733	1/4"
BGS 2734	9/32"
BGS 2735	5/16"
BGS 2736	3/8"
BGS 2737	15/32"
BGS 2738	9/16"
BGS 2751	5/8"
BGS 2752	11/16"
BGS 2753	13/16"
BGS 2754	3/4"



 1/2" **ESAGONO** **PRO+** **CV**

BGS articolo	DESCRIZIONE
BGS 5052	SET 12 PEZZI, CHIAVI A BUSSOLA ESAGONALI, 5-22 MM, ATT. 1/2"

CARATTERISTICHE

- comprende:
 - bussole lungh. 53 mm: 5 - 6 - 7 - 8 - 10 - 12 mm
 - bussole lungh. 70 mm: 14 - 16 - 17 - 18 - 19 - 22 mm
- finitura satinata cromata
- zigrinate
- peso: 2,0 kg

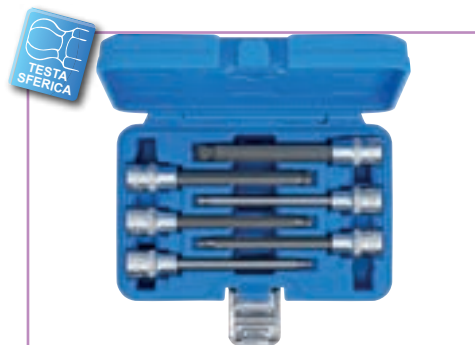

TESTA SFERICA
ESAGONO  1/2" **PRO+** **CV**

BGS articolo	DESCRIZIONE
BGS 4258	SET 6 PEZZI, CHIAVI A BUSSOLA ESAGONALI TESTA SFERICA, ATT. 1/2"

CARATTERISTICHE

- 5-6-7-8-10-12 mm
- lunghezza 140 mm
- peso: 990 g

RICAMBI

BGS articolo	DESCRIZIONE
BGS 4258-5	5 MM
BGS 4258-6	6 MM
BGS 4258-7	7 MM
BGS 4258-8	8 MM
BGS 4258-10	10 MM
BGS 4258-12	12 MM



 1/2" **ESAGONO** **PRO+** **CV**

BGS articolo	DESCRIZIONE
BGS 5181	SET 30 PEZZI, CHIAVI A BUSSOLA ESAGONALI ASSORTITE, ATT. 1/2"

CARATTERISTICHE

- inserti corti acciaio S2
- comprende:
 - lunghezza 55 mm: 5-6-7-8-10-12-14-17-19 mm
 - lunghezza 100 mm: 5-6-7-8-10-11-12-13 mm
 - lunghezza 140 mm: 5-6-7-8-10-12-14 mm
 - lunghezza 200 mm: 5-6-7-8-10-12 mm
- peso: 5,1 kg

RICAMBI

BGS articolo	DESCRIZIONE
BGS 5181-LEER	CASSETTA VUOTA

1/2"



BGS articolo	DESCRIZIONE
BGS 8887	SERIE 6 PEZZI, CHIAVI A BUSSOLA ESAGONALI, 6-14 MM, ATT. 1/2"

CARATTERISTICHE
<ul style="list-style-type: none"> • misure: 6 - 7 - 8 - 10 - 12 - 14 mm • attacco quadro 1/2" • zigrinate • finitura cromata satinata • peso: 540 g



BGS articolo	DESCRIZIONE
BGS 5099	SERIE 10 PEZZI, CHIAVI A BUSSOLA ESAGONALI EXTRA CORTE, 4 - 19 MM, ATT. 1/4" - 3/8" - 1/2"

CARATTERISTICHE
<ul style="list-style-type: none"> • attacco 1/4", lunghezza 30 mm: 4 - 5 - 6 - 7 - 8 mm • attacco 3/8", lunghezza 38 mm: 10 - 12 - 14 mm • attacco 1/2", lunghezza 48 mm: 17 - 19 mm • zigrinate • finitura cromata satinata • su guida metallica • peso: 580 g



novità



BGS articolo	DESCRIZIONE
BGS 5176	SET 8 PEZZI, CHIAVI A BUSSOLA, ATT 1/2", ESAGONO MASCHIO 5 - 13 MM

CARATTERISTICHE
<ul style="list-style-type: none"> • per uso a mano • zigrinate • su guida • attacco quadro 1/2" • impronta: Esagonale maschio • materiale: acciaio al cromo vanadio (S2) • lunghezza: 100 mm • comprende: <ul style="list-style-type: none"> 5 mm (BGS 4260) - 6 mm (BGS 4261) 7 mm (BGS 4262) - 8 mm (BGS 4263) 10 mm (BGS 4264) - 11 mm (BGS 4266) 12 mm (BGS 4265) - 13 mm (BGS 4267) • peso 980 g



novità



BGS articolo	DESCRIZIONE
BGS 5171	SET 18 PEZZI, CHIAVI A BUSSOLA ATTACCO 1/4" E 1/2", ESAGONALI

CARATTERISTICHE
<ul style="list-style-type: none"> • per uso a mano • zigrinate • impronta: Esagonale • materiale: acciaio al cromo vanadio (S2) • attacco quadro • finitura: cromata satinato • comprende: <ul style="list-style-type: none"> - bussole attacco 1/4", Esagonali: <ul style="list-style-type: none"> 3 mm (BGS 2497) - 4 mm (BGS 2498) 5 mm (BGS 2499) - 6 mm (BGS 2500) 7 mm (BGS 2501) - 8 mm (BGS 2502) - bussole attacco 1/2", Esagonali: <ul style="list-style-type: none"> 6 mm (BGS 4252) - 7 mm (BGS 4253) 8 mm (BGS 4254) - 10 mm (BGS 4255) 12 mm (BGS 4256) - 14 mm (BGS 4257) - bussole, attacco 1/2", lunghezza 100 mm, Esagonali: <ul style="list-style-type: none"> 5 mm (BGS 4260) - 6 mm (BGS 4261) 7 mm (BGS 4262) - 8 mm (BGS 4263) 10 mm (BGS 4264) - 12 mm (BGS 4265) • peso: 1,8 kg

1/2"





BCS articolo	DESCRIZIONE
BGS 74257	SET 13 PEZZI, CHIAVI A BUSSOLA ESAGONALI METRICHE 2-14 MM, ATT. 1/4"-3/8"-1/2"

CARATTERISTICHE	
• per uso a mano	
• zigrinate	
• impronta: esagonale	
• attacco: 1/4", 3/8", 1/2"	
• materiale: acciaio al cromo vanadio (S2)	
• comprende:	
- bussole attacco 1/4", esagonali: 2 mm (BGS 5153), 2,5 mm (BGS 5154), 3 mm (BGS 2497), 4 mm (BGS 2498), 5 mm (BGS 2499), 5,5 mm (BGS 9466), 6 mm (BGS 2500)	
- bussole attacco 3/8", esagonali: 7 mm (BGS 2580), 8 mm (BGS 2581), 9 mm (BGS 2583), 10 mm (BGS 2582), 12 mm (BGS 2584)	
- bussole attacco 1/2", esagonali: 12 mm (BGS 4256)	
• peso: 660 g	



BCS articolo	DESCRIZIONE
BGS 74258	SET 32 PEZZI, CHIAVI A BUSSOLA ESAGONALI, METRICHE 2-19 MM & IN POLLICI 1/4 - 9/16", ATT. 1/4"-3/8"-1/2"

CARATTERISTICHE	
• per uso a mano	
• zigrinate	
• impronta: esagonale	
• attacco: 1/4", 3/8", 1/2"	
• materiale: acciaio al cromo vanadio (S2)	
• comprende:	
- bussole attacco 1/4", esagonali metriche: 2 mm (BGS 5153), 2,5 mm (BGS 5154), 3 mm (BGS 2497), 4 mm (BGS 2498), 5 mm (BGS 2499), 5,5 mm (BGS 9466), 6 mm (BGS 2500)	
- bussole attacco 1/4", esagonali in pollici: 5/64", 3/32" (BGS 2740), 1/8" (BGS 2741), 5/32" (BGS 2742), 3/16" (BGS 2743), 7/32" (BGS 2744), 1/4" (BGS 2745)	
- bussole attacco 3/8", esagonali metriche: 7 mm (BGS 2580), 8 mm (BGS 2581), 9 mm (BGS 2583), 10 mm (BGS 2582), 12 mm (BGS 2584)	
- bussole attacco 3/8", esagonali in pollici: 9/32" (BGS 2730), 5/16" (BGS 2727), 3/8" (BGS 2729), 7/16", 1/2"	
- bussole attacco 1/2", esagonali metriche: 14 mm (BGS 4257), 15 mm, 17 mm (BGS 5184-H17), 19 mm (BGS 5184-H19)	
- bussole attacco 1/2", esagonali in pollici: 9/16" (BGS 2738), 5/8" (BGS 2751), 11/16" (BGS 2752), 3/4" (BGS 2754)	
• peso 2,6 kg	



BCS articolo	DESCRIZIONE
BGS 5173	SET 18 PEZZI, CHIAVI A BUSSOLA ATTACCO 1/4" E 1/2", TORX

CARATTERISTICHE	
• per uso a mano	
• zigrinate	
• impronta: Torx	
• zigrinate	
• materiale: acciaio al cromo vanadio (S2)	
• attacco quadro	
• comprende:	
- bussole attacco 1/4", Torx, lunghezza 38 mm: TX10 (BGS 2590) - TX15 (BGS 2591) TX20 (BGS 2592) - TX25 (BGS 2593) TX27 (BGS 2594) - TX30 (BGS 2595)	
- bussole attacco 1/2", Torx, lunghezza 55 mm: TX30 (BGS 4371) - TX40 (BGS 4372) TX45 (BGS 4373) - TX50 (BGS 4374) TX55 (BGS 4375) - TX60 (BGS 4378)	
- bussole, attacco 1/2", Torx, lunghezza 100 mm: TX30 (BGS 4471) - TX40 (BGS 4472) TX45 (BGS 4473) - TX50 (BGS 4474) TX55 (BGS 4475) - T60 (BGS 4476)	
• peso 1,5 kg	

1/2"



BGS articolo	DESCRIZIONE
BGS 5182	SET 32 PEZZI, CHIAVI A BUSSOLA TORX ASSORTITE, ATT. 1/2"

CARATTERISTICHE

- inserti corti acciaio S2
- comprende:
 - lunghezza 55 mm: TX20-TX25-TX27-TX30-TX40 TX45-TX50-TX55-TX60-TX70
 - lunghezza 100 mm: TX20-TX25-TX27-TX30-TX40 TX45-TX50-TX55-TX60-TX70
 - lunghezza 140 mm: TX40-TX45-TX50-TX55-TX60-TX70
 - lunghezza 200 mm: TX40-TX45-TX50-TX55-TX60-TX70
- peso: 5,2 kg



BGS articolo	DESCRIZIONE
BGS 5100	SET 19 PEZZI, BUSSOLE TORX FEMMINA E BUSSOLE CON INSERTI TORX, ATT. 1/2"

CARATTERISTICHE

- comprende:
 - bussole Torx femmina, att.. 1/2": E10, E11, E12, E14, E16, E18, E20, E22, E24
 - bussole con inserti Torx, att. 1/2": TX20, TX25, TX27, TX30, TX40, TX45, TX50, TX55, TX60, TX70
- finitura cromata satinata
- peso: 1,8 kg

RICAMBI

BGS articolo	DESCRIZIONE
BGS 5100-LEER	CASSETTA VUOTA



BGS articolo	DESCRIZIONE
BGS 8886	SERIE 6 PEZZI, CHIAVI A BUSSOLA, TORX TX40-TX55, ATT. 1/2"

CARATTERISTICHE

- misure: Tx40 - Tx45 - Tx50 - Tx55
- attacco quadro 1/2"
- zigrinate
- finitura cromata satinata
- peso: 320 g

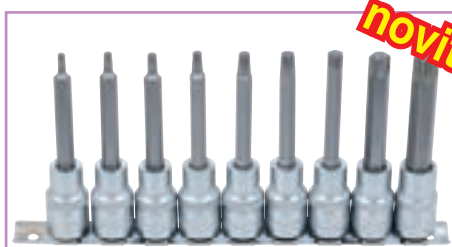

novità



BGS articolo	DESCRIZIONE
BGS 5177	SET 9 PEZZI, CHIAVI A BUSSOLA, ATT. 1/2", TORX, TX20-TX60

CARATTERISTICHE

- per uso a mano
- zigrinate
- su guida
- attacco quadro 1/2"
- impronta: Torx maschio
- materiale: acciaio al cromo vanadio (S2)
- **lunghezza: 100 mm**
- comprende:
 - TX20 (BGS 4469) - TX25 (BGS 4470)
 - TX27 (BGS 4467) - TX30 (BGS 4471)
 - TX40 (BGS 4472) - TX45 (BGS 4473)
 - TX50 (BGS 4474) - TX55 (BGS 4475)
 - TX60 (BGS 4476)
- peso 930 g



BGS articolo	DESCRIZIONE
54019	CASSETTA PLASTICA 19 PEZZI

attacco: 1/2"
impronta: TORX®

BGS articolo	DESCRIZIONE	
54019	CASSETTA PLASTICA 19 PEZZI	1

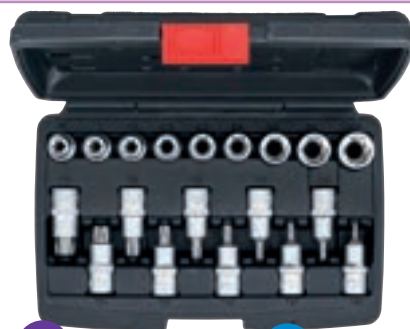

BGS articolo	DESCRIZIONE
BGS 95100	SET 19 PEZZI, BUSSOLE TORX FEMMINA E BUSSOLE CON INSERTI TORX, ATT. 1/2"

CARATTERISTICHE

- comprende:
 - bussole Torx femmina, att.. 1/2": E10, E11, E12, E14, E16, E18, E20, E22, E24
 - bussole con inserti Torx, att. 1/2": TX20, TX25, TX27, TX30, TX40, TX45, TX50, TX55, TX60, TX70
- finitura cromata satinata
- peso: 1,7 kg



 1/4"-3/8"-1/2" 

BGS articolo	DESCRIZIONE
BGS 5098	SERIE 12 PEZZI, CHIAVI A BUSSOLA TORX EXTRA CORTE, T8 - T60, ATT. 1/4" - 3/8" - 1/2"

- CARATTERISTICHE**
- attacco 1/4", lunghezza 30 mm: T8 - T10 - T15 - T20 - T25 - T27
 - attacco 3/8", lunghezza 38 mm : T30 - T40 - T45 - T50 - T55
 - attacco 1/2", lunghezza 48 mm: T60
 - zigrinate
 - finitura cromata satinata
 - su guida metallica
 - peso: 400 g

TORX®	S mm	S mm	
T 6	1.70	T 40	6.70
T 7	2.00	T 45	7.90
T 8	2.30	T 50	8.90
T 9	2.50	T 55	11.30
T 10	2.70	T 60	13.30
T 15	3.30	T 70	15.60
T 20	3.90	T 80	17.60
T 25	4.50	T 90	20.00
T 27	5.00	T 100	22.20
T 30	5.60		





novità

   **TORX® CON FORO**  1/4"  1/2"

BGS articolo	DESCRIZIONE
BGS 5174	SET 18 PEZZI, CHIAVI A BUSSOLA ATTACCO 1/4" E 1/2", TORX C/FORO

- CARATTERISTICHE**
- per uso a mano
 - zigrinate
 - impronta: Torx C/ FORO
 - zigrinate
 - materiale: acciaio al cromo vanadio (S2)
 - attacco quadro
 - finitura: cromata satinata
 - comprende:
 - bussole attacco 1/4", Torx C/FORO, **lunghezza 38 mm:**
TH10 (BGS 2357) - TH15 (BGS 2358)
TH20 (BGS 2359) - TH25 (BGS 2360)
TH27 (BGS 2361) - TH30 (BGS 2362)
 - bussole attacco 1/2", Torx C/FORO, **lunghezza 55 mm:**
TH30 - TH40 (BGS 4326)
TH45 (BGS 4327) - TH50 (BGS 4328)
TH55 (BGS 4329) - TH60 (BGS 4376)
 - bussole, attacco 1/2", Torx C/FORO, **lunghezza 100 mm:**
TH30 - TH40 - TH45 - TH50 - TH55 - TH60
 - peso 1,5 kg



DISPONIBILI TUTTI I RICAMBI

 1/2"  **TORX® CON FORO**

- CASSETTA CHIAVI A BUSSOLA TORX® CON FORO**
- N. 10 T20, T25, T27, T30, T40, T45, T50, T55, T60, T70 - L. 55 MM
 - N. 10 T20, T25, T27, T30, T40, T45, T50, T55, T60, T70 - L. 100 MM
 - N. 6 T40, T45, T50, T55, T60, T70 L. 140 MM
 - N. 6 T40, T45, T50, T55, T60, T70 L. 200 MM

attacco: 1/2"
impronta: TORX® CON FORO

BGS articolo	Descrizione	
4203	CASSETTA PLASTICA 32 PEZZI	1





TORX **TORX**
CON FORO

1/2" **PRO+** **CV**

BGS articolo	DESCRIZIONE
BGS 5101	SET 27 PEZZI, INSERTI E CHIAVI A BUSSOLA TORX, ATT. 1/2"

- CARATTERISTICHE**
- durezza e coppia in conformità con le norme tedesche DIN
 - 5 chiavi a bussola attacco da 1/2": T45-50-55-60-70
 - 7 inserti per viti Torx: T10-15-20-25-27-30-40
 - 12 inserti per viti Torx c/foro: T10-15-20-25-27-30-40-45-50-55-60-70
 - 3 adattatori per inserti attacco da 1/4" - 3/8 - 1/2"
 - peso: 1,2 kg



1/2" **PRO+** **CV** **TORX**
CON FORO

BGS articolo	DESCRIZIONE
BGS 8885	SERIE 4 PEZZI, BUSSOLE TORX CON FORO TH40-TH55, ATT. 1/2"

- CARATTERISTICHE**
- misure: Th40 - Th45 - Th50 - Th55
 - attacco quadro 1/2"
 - zigrinate
 - finitura cromata satinata
 - peso: 310 g

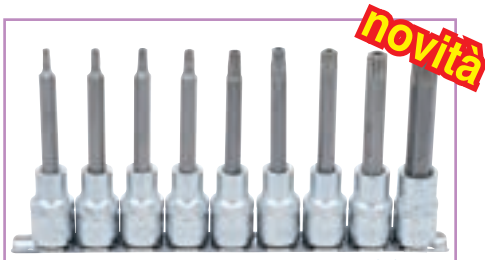

novità

PRO+ **CV** 1/2" **TORX**
CON FORO

BGS articolo	DESCRIZIONE
BGS 5178	SET 9 PEZZI, CHIAVI A BUSSOLA, ATT. 1/2", TORX C/FORO, TH20-TH60

- CARATTERISTICHE**
- per uso a mano
 - zigrinate
 - su guida
 - attacco quadro 1/2"
 - impronta: Torx c/ Foro maschio
 - materiale: acciaio al cromo vanadio (S2)
 - **lunghezza: 100 mm**
 - comprende: TH20 - TH25 - TH27 - TH30 - TH40 - TH45 - TH50 - TH55 - TH60
 - peso 920 g



Mercedes-Benz **MAN** Audi **BMW**
CITROËN **Ford** **RENAULT**

1/2" **TORX**
CON FORO **PRO+** **CV**

BGS articolo	DESCRIZIONE
BGS 5103	SET 4 PEZZI, CHIAVI A BUSSOLA TORX CON FORO, ATT. 1/2"

- CARATTERISTICHE**
- TH70 (testa cilindri di molte marche, vasca filtro olio)
 - TH80 (assemblaggio braccio tergicristalli, MAN, serie M)
 - TH90 (bulloni per testata cilindri)
 - TH100 (leva dello sterzo, MAN, serie F)
 - idonee per l'assemblaggio di bulloni per testata cilindri di Ford, BMW, Citroen, Renault, Audi, Mercedes)
 - peso: 1,2 kg

RICAMBI	
BGS articolo	DESCRIZIONE
BGS 5103-TB70	TH 70
BGS 5103-TB80	TH 80
BGS 5103-TB90	TH 90
BGS 5103-TB100	TH 100

1/2"





BGS 2020

BGS articolo	DESCRIZIONE
BGS 2028	SET 6 PEZZI, BUSSOLE TORX EXTRA LUNGO, ATT. 1/2"

CARATTERISTICHE

- E 10 - 12 - 14 - 16 - 18 - 20
- lunghezza: 140 mm
- con sfera di bloccaggio
- peso: 2,1 kg

RICAMBI

BGS articolo	DESCRIZIONE
BGS 2020	BUSSOLA E12X150 MM PER TESTATE BMW



1/2"  **PRO+** **CV S2**

BGS articolo	DESCRIZIONE
BGS 5190	SET 32 PEZZI, CHIAVI A BUSSOLA TORX PLUS, ATT. 1/2"

CARATTERISTICHE

- zigrinate
- per Torx Plus
- comprende:
 - lunghezza 55 mm: TS20, TS25, TS27, TS30, TS40, TS45, TS50, TS55, TS60, TS70
 - lunghezza 100 mm: TS20, TS25, TS27, TS30, TS40, TS45, TS50, TS55, TS60, TS70
 - lunghezza 140 mm: TS40, TS45, TS50, TS55, TS60, TS70
 - lunghezza 200 mm: TS40, TS45, TS50, TS55, TS60, TS70
- peso: 5,7 kg

	S mm		S mm	
8 IP	2.30	30 IP	5.60	
9 IP	2.50	40 IP	6.70	
10 IP	2.70	45 IP	7.90	
15 IP	3.30	50 IP	8.90	
20 IP	3.90	55 IP	11.30	
25 IP	4.50	60 IP	13.30	
27 IP	5.00			



1/2"  **PRO+** **CV S2**

BGS articolo	DESCRIZIONE
BGS 5191	SET 32 PEZZI, CHIAVI A BUSSOLA 5 PUNTE CON FORO, ATT. 1/2"

CARATTERISTICHE

- zigrinate
- per 5 punte con foro
- comprende:
 - lunghezza 55 mm: TP20, TP25, TP27, TP30, TP40, TP45, TP50, TP55, TP60, TP70
 - lunghezza 100 mm: TP20, TP25, TP27, TP30, TP40, TP45, TP50, TP55, TP60, TP70
 - lunghezza 140 mm: TP40, TP45, TP50, TP55, TP60, TP70
 - lunghezza 200 mm: TP40, TP45, TP50, TP55, TP60, TP70
- peso: 5,8 kg

PENTALOBATA	S mm		S mm	
8 PR	2.20	27 PR	4.70	
9 PR	2.40	30 PR	5.20	
10 PR	2.60	40 PR	6.30	
15 PR	3.10	45 PR	7.40	
20 PR	3.60	50 PR	8.40	
25 PR	4.10	55 PR	10.60	



RIBE XZN TORX® TORX®

1/2" PRO+ CV

BGS articolo	DESCRIZIONE
BGS 5014	SET 9 PEZZI, CHIAVI A BUSSOLA SPECIALI PER TESTATE CILINDRI, ATT. 1/2"

CARATTERISTICHE

- inserti con finitura nera
- peso: 2,1 kg

RICAMBI

BGS articolo	DESCRIZIONE
BGS 5009	XZN 10 X 140 MM
BGS 5010	RIBE 12 X 120 MM



1/2" RIBE PRO+ CV

BGS articolo	DESCRIZIONE
BGS 5183	SET 32 PEZZI, CHIAVI A BUSSOLA RIBE, ATT. 1/2"

CARATTERISTICHE

- inserti corti acciaio S2
- comprende:
 - lunghezza 55 mm: M 5-6-7-8-9-10-12-13-14
 - lunghezza 100 mm: M 5-6-7-8-9-10-12-13-14
 - lunghezza 140 mm: M 8-9-10-10.3-12-13-14
 - lunghezza 200 mm: M 8-9-10-10.3-12-13-14
- peso: 5,6 kg



3/8" 1/2" RIBE PRO+ CV

BGS articolo	DESCRIZIONE
BGS 5185	SERIE 7 PEZZI, CHIAVI A BUSSOLA RIBE, ATT. 3/8" - 1/2"

CARATTERISTICHE

- Ribe: M6, M7, M8, M10 con attacco 3/8"
- Ribe: M12, M13, M14 con attacco 1/2"
- in acciaio al cromo vanadio
- satinato, zigrinate
- lunghezza: 75 mm
- su guida
- peso: 640 g

RIBE	S mm	W mm
M 5	5.00	1.20
M 6	6.00	1.30
M 7	7.00	1.40
M 8	8.00	1.80
M 9	9.00	2.00
M 10	10.00	2.30
M 12	12.00	2.60
M 13	13.00	3.10
M 14	14.00	3.20
M 16	16.00	3.60

novità



BGS articolo	DESCRIZIONE
BGS 5175	SET 7 PEZZI, CHIAVI A BUSSOLA ATT. 1/2", XZN, M5 - M14

CARATTERISTICHE

- per uso a mano
- zigrinate
- su guida
- attacco quadro 1/2"
- impronta: XZN maschio
- materiale: acciaio al cromo vanadio (S2)
- **lunghezza: 100 mm**
- comprende:
 - M5 (BGS 4359) - M6 (BGS 4360)
 - M8 (BGS 4361) - M9 (BGS 5184-M9)
 - M10 (BGS 4362) - M12 (BGS 4363)
 - M14 (BGS 4364)
- peso 850 g



1/2" PRO+ CV XZN

BGS articolo	DESCRIZIONE
BGS 8449	SET 5 PEZZI, CHIAVI A BUSSOLA BUSSOLA XZN, ATT. 1/2"

CARATTERISTICHE

- inserti corti acciaio S2
- comprende
 - M 12 x 55 mm
 - M 9 x 100 mm
 - M 10 x 140 mm
 - M 12 x 140 mm
 - M 14 x 140 mm
- peso: 930 g



PRO+ CV XZN 1/4" 1/2"

BGS articolo	DESCRIZIONE
BGS 5172	SET 18 PEZZI, CHIAVI A BUSSOLA ATTACCO 1/4" E 1/2", XZN

CARATTERISTICHE

- per uso a mano
- zigrinate
- impronta: XZN
- zigrinate
- materiale: acciaio al cromo vanadio (S2)
- attacco quadro
- comprende:
 - bussole attacco 1/4", XZN, **lunghezza 38 mm**: M4 (BGS 5105-M4) - M5 (BGS 5105-M5) - M6 (BGS 5105-M6) - M8 (BGS 2503) - M10 (BGS 2506) - M12 (BGS 2507)
 - bussole attacco 1/2", XZN, **lunghezza 55 mm**: M8 (BGS 4352) - M10 (BGS 4353) - M12 (BGS 4354) - M14 (BGS 4344) - M16 (BGS 4356) - M18
 - bussole, attacco 1/2", XZN, **lunghezza 100 mm**: M8 (BGS 4361) - M10 (BGS 4362) - M12 (BGS 4363) - M14 (BGS 4364) - M16 - M18
- peso 2,2 kg



1/2" XZN PRO+ CV

BGS articolo	DESCRIZIONE
BGS 5180	SET 26 PEZZI, CHIAVI A BUSSOLA XZN, ATT. 1/2"

CARATTERISTICHE

- inserti corti acciaio S2
- comprende:
 - lunghezza 55 mm: M 5-6-8-9-10-12-14-16
 - lunghezza 100 mm: M 5-6-8-9-10-12-14
 - lunghezza 140 mm: M 5-6-8-9-10-12-14
 - lunghezza 200 mm: M 8-10-12-14
- peso: 4,6 kg

XXL



1/2" XZN PRO+ CV

BGS articolo	DESCRIZIONE
BGS 4224	SET 3 PEZZI, CHIAVI A BUSSOLA CON INSERTO PER ALBERO MOTORE, 800 MM, ATT. 1/2"

CARATTERISTICHE

- idoneo per viti albero motore
- non vi è necessità di barre di prolunga
- idoneo per VW e altre marche
- M8 x 800 mm, M10 e M12 x 800 mm
- peso: 2,0 kg

XZN	S mm	S mm
M 4	3,60	M12 11,50
M 5	4,80	M14 13,30
M 6	6,10	M16 15,70
M 8	7,30	M18 16,90
M10	9,70	



1/4"-3/8"-1/2" XZN

CV PRO+

BGS articolo	DESCRIZIONE
BGS 5105	SERIE 8 PEZZI, CHIAVI A BUSSOLA XZN, ATT. 1/4" - 3/8" - 1/2"

CARATTERISTICHE

- comprende:
 - attacco 1/4": M4-M5-M6
 - attacco 3/8": M8-10-12
 - attacco 1/2": M-14-16
- finitura cromata satinata
- su guida metallica
- peso: 460 g

1/2"

 BGS
 articolo

DESCRIZIONE

BGS 5188

**SET 49 PEZZI,
 CHIAVI A BUSSOLA
 ATT. 1/2"**

CARATTERISTICHE

- comprende i seguenti utensili attacco 1/2":
 - chiavi a bussola Torx maschio, lungh. 55 mm: TX20-TX25-TX27-TX30-TX40-TX45-TX50-TX55-TX60-TX70
 - chiavi a bussola Torx maschio, lungh. 100 mm: TX25 - TX30 - TX40 - TX45 - TX50 - TX60
 - chiavi a bussola Esagono maschio, lungh. 55 mm: 5 - 6 - 7 - 8 - 10 - 12 - 14 - 17 - 19 mm
 - chiavi a bussola Esagono maschio, lungh. 100 mm: 6 - 7 - 8 - 10 - 12 mm
 - chiavi a bussola XZN maschio, lungh. 55 mm: M5 - M6 - M8 - M10
 - chiavi a bussola XZN maschio, lungh. 100 mm: M6 - M8 - M10 - M12 - M14
 - inserti Torx con foro, lungh. 30 mm: TH20 - TH25 - TH27 - TH30 - TH40 - TH45 - TH50 - TH55 - TH60
 - bussola portainseriti att. 1/2"
- peso: 5,5 kg

TESTA SFERICA

ESAGONO TORX® XZN

 BGS
 articolo

DESCRIZIONE

BGS 5170

**SET 20 PEZZI, CHIAVI
 A BUSSOLA MASCHIO
 CON TESTA SFERICA,
 ESAGONALI, TORX,
 XZN**

CARATTERISTICHE

- bussole con testa sferica
- consente di lavorare in sicurezza anche in aree di lavoro difficili
- consente l'avvitamento obliquo
- per uso a mano
- zigrinate
- in cassetta in plastica
- **lunghezza: 100 mm**
- attacco quadro 1/2"
- materiale: acciaio al cromo vanadio (S2)
- comprende:
 - bussole **Esagonali** maschio, con Testa Sferica, lunghezza 100 mm, att. 1/2": 4 - 5 - 6 - 7 - 8 - 10 - 12 mm
 - bussole **Torx** maschio, con Testa Sferica, lunghezza 100 mm, att. 1/2": TX20 - TX25 - TX30 - TX45 - TX50 - TX55
 - bussole **XZN** maschio, con Testa Sferica, lunghezza 100 mm, att. 1/2": M5 - M6 - M8 - M10 - M12
- peso 2,5 kg

Set che comprende:

- 1 Cassetta chiavi a bussola Esagonali



 ESAGONO

- 1 cassetta chiavi a bussola Torx



 TORX®

- 1 Cassetta chiavi a bussola XZN



 XZN

CV

 BGS
 articolo

DESCRIZIONE

BGS 5186

**SET 88 PEZZI,
 CHIAVI A BUSSOLA
 ESAGONALI, TORX E
 XZN, ATT. 1/2"**

CARATTERISTICHE

- cassetta chiavi a bussola Esagonali:
 - lunghezza 55 mm: 5-6-7-8-10-12-14-17-19 mm
 - lunghezza 100 mm: 5-6-7-8-10-11-12-13 mm
 - lunghezza 140 mm: 5-6-7-8-10-12-14 mm
 - lunghezza 200 mm: 5-6-7-8-10-12 mm
- cassetta chiavi a bussola Torx:
 - lunghezza 55 mm TX: 20-25-27-30-40-45-50-55-60-70
 - lunghezza 100 mm TX: 20-25-27-30-40-45-50-55-60-70
 - lunghezza 140 mm TX: 40-45-50-55-60-70
 - lunghezza 200 mm TX: 40-45-50-55-60-70
- cassetta chiavi a bussola XZN:
 - lungh. 55 mm: M5-M6-M8-M9-M10-M12-M14-M16
 - lunghezza 100 mm: M5-M6-M8-M9- M10-M12-M14
 - lunghezza 140 mm: M5-M6-M8-M9- M10-M12-M14
 - lunghezza 200 mm: M8-M10-M12-M14
- peso: 13,9 kg



DISPONIBILI
TUTTI I RICAMBI



1/2"

PRO+



CV



QUADRO



articolo

DESCRIZIONE

BGS 1016

**SERIE 6 PEZZI,
CHIAVI PER TAPPI
SCARICO OLIO,
8-14 MM - 3/8" + 1/2",
ATT. 1/2"**

CARATTERISTICHE

- finitura cromata satinata
- su guida porta bussola
- attacco 1/2"
- misure quadro maschio: 8-10-12-14 mm, 1/2" & 3/8"
- peso: 450 g

RICAMBI



articolo



BGS 1016-1

8 MM

BGS 1016-2

3/8"

BGS 1016-3

10 MM

BGS 1016-4

12 MM

BGS 1016-5

1/2"

BGS 1016-6

14 MM



1/2"



TORX®



TORX®



RIBE

**CASSETTA CHIAVI A BUSSOLA M/F TORX®
E RIBE®**

• **N. 9 BUSSOLE TORX® FEMMINA E 10-11-12-14-16-18-20-22-24**

• **N. 18 CHIAVI A BUSSOLA RIBE® M 5-6-7-8-9-10-12-13-14 L. 55**

• **M 5-6-7-8-9-10-12-13-14 L. 100**

• **N. 10 CHIAVI A BUSSOLA TORX® MASCHIO
T 20-25-27-30-40-45-50-55-60-70 L. 55**

attacco: 1/2"

impronta: RIBE® - TORX®



articolo

Descrizione



3704

CASSETTA PLASTICA
37 PEZZI

1

NOTE



ADATTATORI DOPPIO QUADRO MASCHIO

FEFMEC articolo	1/2"	L mm
2841	1/4"	20
3841	3/8"	30
4841	1/2"	37
BGS 9623	3/4"	53
8841	1"	68

CARATTERISTICHE

- con doppia sfera



1/2"

1/2"

PROLUNGHE

BGS articolo	L mm	
485-0050	50	1
BGS 236	75	1
BGS 3120	125	1
BGS 3121	250	1
BGS 3138	450	1
BGS 3139	600	1
BGS 3134	610	1
BGS 2121	750	1

CARATTERISTICHE

- finitura: satinata cromata
- attacco 1/2"

XXL

1/2"



1/2"

BGS articolo	DESCRIZIONE
BGS 92237	SET 3 PEZZI, PROLUNGHE

CARATTERISTICHE

- lunghezze: 450-600-750 mm
- acciaio al carbonio
- peso: 2,8 kg



1/2"

1/2"

PROLUNGHE

FEFMEC articolo	L mm
FM 285-1/2-125	125
FM 285-1/2-250	250

CARATTERISTICHE

- IEC 60900
- 1000 V



1/2"

1/2"

PROLUNGHE CON TESTA SFERICA

attacco: 1/2"

FEFMEC articolo	L mm	
BGS 233	50	1
4852-0075	75	1
BGS 234	125	1
BGS 235	250	1
BGS 248	375	1
BGS 249	500	1



1/2"

1/2"

PRO+ CV

BGS articolo	DESCRIZIONE
BGS 2240	SET 3 PEZZI PROLUNGHE

CARATTERISTICHE

- lunghezze: 50-125-250 mm
- **testa sferica**
- finitura cromata satinata
- zigrinate
- peso: 780 g



1/2"



BGS articolo	DESCRIZIONE
BGS 6112	SET 5 PEZZI, PROLUNGHE TESTA SFERICA, ATT. 1/2"

CARATTERISTICHE

- comprende le seguenti misure:
 - att. 1/2", lunghezza: 50, 75, 125, 250, 450 mm
- finitura cromata lucida
- in supporto in plastica
- peso: 1,6 kg

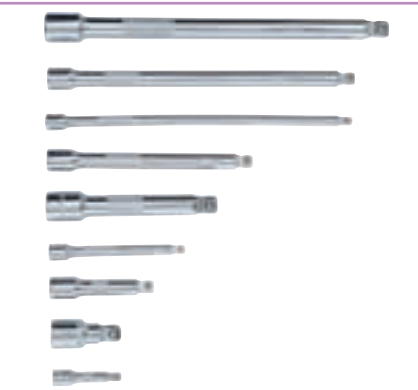

1/4"-3/8"-1/2"



BGS articolo	DESCRIZIONE
BGS 6113	SET 9 PEZZI, PROLUNGHE TESTA SFERICA, ATT. 1/4" - 3/8" - 1/2"

CARATTERISTICHE

- comprende le seguenti misure:
 - att. 1/4", lunghezza: 50, 100, 225 mm;
 - att. 3/8", lunghezza: 75, 150, 225 mm;
 - att. 1/2", lunghezza: 50, 125, 250 mm.
- finitura cromata lucida
- in supporto in plastica
- peso: 1,3 kg



FLEX



 1/2" **PRO+**   1/2"

BGS articolo	DESCRIZIONE
BGS 2323	PROLUNGA FLESSIBILE

CARATTERISTICHE
<ul style="list-style-type: none"> • lunghezza: 190 mm • flessibile fino a 90° • cromata • peso: 280 g

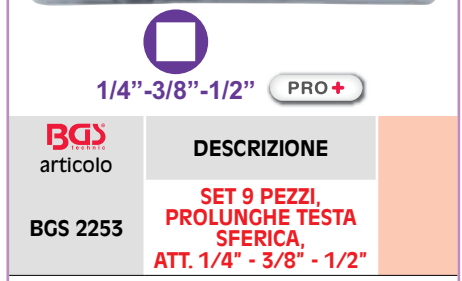

 1/4" - 3/8" - 1/2" **PRO+**

BGS articolo	DESCRIZIONE
BGS 2253	SET 9 PEZZI, PROLUNGHE TESTA SFERICA, ATT. 1/4" - 3/8" - 1/2"

CARATTERISTICHE
<ul style="list-style-type: none"> • comprende le seguenti misure: - att. 1/4", lunghezza: 50 mm, 100 mm, 250 mm; - att. 3/8", lunghezza: 75 mm, 150 mm, 250 mm; - att. 1/2", lunghezza: 50 mm, 125 mm, 250 mm. • peso: 1,9 kg

RICAMBI			
BGS articolo		L mm	
BGS 2232	1/4"	50	
BGS 2231	1/4"	100	
BGS 2219	1/4"	250	
BGS 242	3/8"	75	
BGS 243	3/8"	150	
BGS 244	3/8"	250	
BGS 233	1/2"	50	
BGS 234	1/2"	125	
BGS 235	1/2"	250	

FLEX



 1/2" **PRO+**   1/2"

BGS articolo	DESCRIZIONE
BGS 8483	PROLUNGA FLESSIBILE, 300 MM, ATT. 1/2"

CARATTERISTICHE
<ul style="list-style-type: none"> • lunghezza: 300 mm • permette l'avvitamento anche in aree difficili da raggiungere • peso: 240 g • ATTENZIONE: da non utilizzare per viti bloccate



 1/4" - 3/8" - 1/2"  1/2" - 3/8" - 1/2"

PRO+  

BGS articolo	DESCRIZIONE
BGS 198	SET 3 PEZZI, PROLUNGHE MAGNETICHE, ATT. 1/4" - 3/8" - 1/2"

CARATTERISTICHE
<ul style="list-style-type: none"> • per trattenerne viti e bulloni nella bussola • peso: 400 g



 1/2" **PRO+**   1/2"

BGS articolo	L mm	
BGS 251	75	1

CARATTERISTICHE
• peso: 150 g



 1/4" - 3/8" - 1/2"  1/2" - 3/8" - 1/2"

PRO+  

BGS articolo	DESCRIZIONE
BGS 252	SET 3 PEZZI SNODO CON MOLLA

CARATTERISTICHE
<ul style="list-style-type: none"> • cromati • peso: 290 g

SET 1/2"



F M

SFERA

PRO+ CV Δ 1000 V DVE

RIDUZIONI, ISOLATE VDE, 1000 V

FEFMEC articolo	FEMMINA	MASCHIO
FM 312-3/8-1/2	3/8"	1/2"
FM 312-1/2-3/8	1/2"	3/8"

CARATTERISTICHE

- conformi DIN EN 60900
- isolati VDE fino a 1000 V

F M

1/4"-3/8"-1/2"-3/4" 1/4"-3/8"-1/2"-3/4"

RACCORDI DI RIDUZIONE CHROM-VANADIUM

attacco: 1/4" - 3/8" - 1/2" - 3/4"

BGS articolo	FEMMINA	MASCHIO	
BGS 271	1/4"	3/8"	1
BGS 269	3/8"	1/4"	1
BGS 280	3/8"	1/2"	1
BGS 270	1/2"	3/8"	1
BGS 272	1/2"	3/4"	1
BGS 274	3/4"	1/2"	1

PRO+ CV

BGS articolo	DESCRIZIONE
BGS 199	SET 6 PEZZI, ADATTATORI

CARATTERISTICHE

- cromati satinati

CONTENUTO

- 1/4" F X 3/8" M, coppia massima 60 Nm
- 3/8" F X 1/4" M, coppia massima 60 Nm
- 3/8" F X 1/2" M, coppia massima 200 Nm
- 1/2" F X 3/8" M, coppia massima 200 Nm
- 1/2" F X 3/4" M, coppia massima 500 Nm
- 3/4" F X 1/2" M, coppia massima 500 Nm
- peso: 620 g

RICAMBI

BGS articolo	DESCRIZIONE
BGS 199-LEER	CASSETTA VUOTA

1/4"-3/8"-1/2"

PRO+ CV

BGS articolo	DESCRIZIONE
BGS 8808	SET 4 PEZZI, RIDUZIONI

CARATTERISTICHE

- comprende 4 riduzioni:
 - 1/4" F - 3/8" M
 - 3/8" F - 1/4" M
 - 3/8" F - 1/2" M
 - 1/2" F - 3/8" M
- finitura cromata satinata
- peso: 140 g

F M

RACCORDI DI RIDUZIONE MAGNETICI A SCOMPARSA IDEALI PER CHIAVI DINAMOMETRICHE E SPAZI RIDOTTI

attacco: 1/4"-3/8"-1/2"

FEFMEC articolo	F	M	
1434-1/4	1/4"	3/8"	1
1434-3/8	3/8"	1/2"	1
1434-1/2	1/2"	3/4"	1

SFERA

RIDUZIONI A SCOMPARSA CON SFERA NEL QUADRO MASCHIO

Koken articolo	F	M	D mm	L mm	
2756 Z-3/8	1/4"	3/8"	20.3	21.5	1
2756 Z-1/2	1/4"	1/2"	20.3	26	1
3756 Z-1/2	3/8"	1/2"	28	29	1

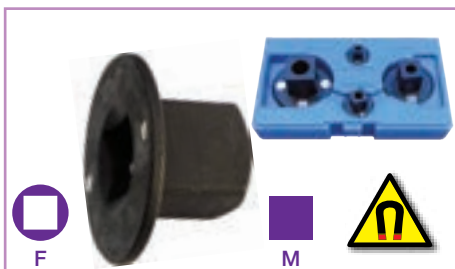

RACCORDI DI RIDUZIONE MAGNETICI "POWER IMPACT" A SCOMPARSA - SPAZI RIDOTTI

articolo	F	M	L mm	
698-00	1/4"	3/8"	17	1
698-0	1/4"	1/2"	22	1
698-1	3/8"	1/2"	22	1
698-11	1/2"	3/4"	30	1
698-8	3/4"	1"	35	1
698-13	1"	1 1/2"	50	1
698-15	1 1/2"	2 1/2"	60	1
698	CASSETTA 4 PZ. CONTENUTO: 1 PZ. 698-00 1 PZ. 698-1 1 PZ. 698-11 1 PZ. 698-8			1

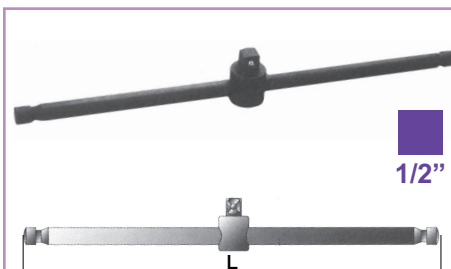

LEVA CON QUADRO SCORREVOLE "POWER IMPACT" BRUNITA

articolo	L mm	
752050	300	1

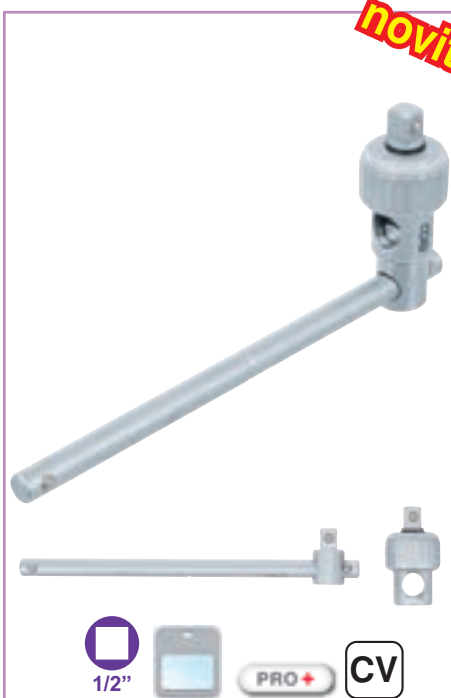

articolo	DESCRIZIONE
BGS 71047	ADATTATORE CON FUNZIONE DI CRICCHETTO, CON LEVA CON QUADRO SCORREVOLE, ATT. 1/2"

- CARATTERISTICHE**
- adattatore a cricchetto reversibile per azione Dx e Sx
 - materiale: acciaio al cromo vanadio
 - materiale adattatore a cricchetto: acciaio al cromo molibdeno
 - finitura: cromata satinata
 - attacco quadro 1/2"
 - con cricchetto a 52 denti
 - peso 690 g



articolo	DESCRIZIONE
BGS 289	ADATTATORE SCORREVOLE PER BARRE ATT. 1/2"

- CARATTERISTICHE**
- cromata, satinata
 - per impiego con prolunghe
 - peso: 80 g



QUADRO MASCHIO SCORREVOLE

articolo	L mm	
BGS 273	250	1
487	300	1

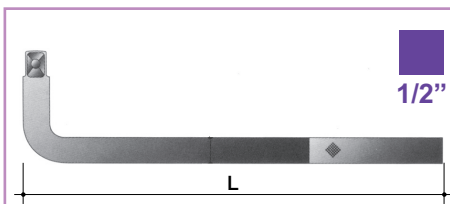

QUADRO MASCHIO AD ANGOLO "POWER IMPACT" BRUNITO

articolo	L mm	
762051	250	1



articolo	DESCRIZIONE
BGS 1459	CHIAVE A CROCE PER RUOTE DI AUTOMOBILI

- CARATTERISTICHE**
- esagono 17, 19, 21 mm, quadro maschio da 1/2"
 - finitura cromata, temperata
 - lunghezza braccio 150 mm
 - conforme DIN 899
 - peso: 1,2 kg



articolo	DESCRIZIONE
BGS 1456	CHIAVE A CROCE PER RUOTE DI AUTOMOBILI, RIPIEGABILE, GIUNTO ARTICOLATO

- CARATTERISTICHE**
- esagono 17, 19, 21 mm + quadro maschio 1/2"
 - lunghezza 400 mm
 - maggiore coppia grazie al giunto regolabile
 - peso: 1,4 kg

 MECCANISMO
 72
 DENTI

 1/2" ESAGONO

 BGS
 articolo

DESCRIZIONE

BGS 1510

**CHIAVE PER DADI
 RUOTA ESTENSIBILE,
 ATTACCO 1/2",
 17-19 MM**

CARATTERISTICHE

- bussola intercambiabile con attacco quadro femmina da 1/2", un lato 17 mm esagonale, l'altro lato esagonale 19 mm
- impugnatura rivestita in gomma
- barra estensibile in lunghezza fino a 520 mm
- peso: 910 g



 CRO
 MO

 CV

 1/2"

 PRO+

 BGS
 articolo

DESCRIZIONE

BGS 6851

**IMPUGNATURA
 SNODATA 1/2",
 450 MM**

CARATTERISTICHE

- impugnatura in acciaio al cromo vanadio con testa in acciaio al cromo molibdeno
- attacco quadro: 1/2"
- lunghezza: 450 mm
- coppia massima: 500 Nm
- peso: 1,1 kg



BGS 265-REPAIR



 1/2"

 PRO+

 CV

IMPUGNATURE SNODATE

 BGS
 articolo

BGS 265

1/2"

L

mm

BGS 267

1/2"

610

CARATTERISTICHE

- cromata
- attacco quadro nero
- coppia massima 500 Nm

RICAMBI

 BGS
 articolo

BGS 265-REPAIR

**KIT DI RIPARAZIONE
 PER ART. BGS 265**

BGS 267-REPAIR

**KIT DI RIPARAZIONE
 PER ART. BGS 267**

 1/2"

 PRO+

 CV

 CRO
 MO

 BGS
 articolo

BGS 258

DESCRIZIONE

**IMPUGNATURA
 SNODATA ESTENSIBILE**

CARATTERISTICHE

- lunghezza: da 450 a 600 mm
- finitura satinata cromata
- testa con finitura nera
- coppia massima 550 Nm
- peso: 1,1 kg



BGS 228-1



 1/2"

 PRO+

 CV

 BGS
 articolo

BGS 228

DESCRIZIONE

**IMPUGNATURA
 SNODATA CON TESTA
 A CRICCHETTO**

CARATTERISTICHE

- lunghezza 620 mm
- coppia massima 512 Nm
- peso: 1,6 kg

RICAMBI

 BGS
 articolo

BGS 228-1

DESCRIZIONE

KIT DI RIPARAZIONE

 AUTOMOTIVE INDUSTRIAL TOOLS

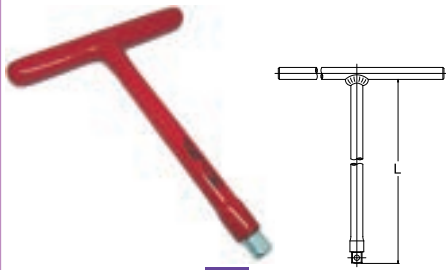

1/2"

1000 V 

CHIAVI A "T"

FEFMEC articolo	M	L mm
FM 290-1/2	1/2"	200

CARATTERISTICHE

- IEC 60900
- 1000 V



TESTA SFERICA

1/2" PRO+ CV

BGS articolo	DESCRIZIONE
BGS 7805-1	IMPUGNATURA A T, CON QUADRO MASCHIO DA 1/2", LUNGHEZZA 230 MM, TESTA SFERICA

CARATTERISTICHE

- impugnatura ergonomica
- finitura satinata
- peso: 240 g



1/2"

CHIAVE A "T" QUADRO MASCHIO SNODATA CROMATA ASTA SCORREVOLE CHROM-VANADIUM

FEFMEC articolo	M	L mm	
581-1/2	1/2"	500	1



1/2" PRO+ CV

BGS articolo	DESCRIZIONE
BGS 25150	CHIAVE A BATTERE PER DADI E PULEGGE

CARATTERISTICHE

- 620 mm
- idoneo per diverse applicazioni, ad esempio allentamento della vite di tenuta puleggia cinghia, contralbero
- speciale impugnatura di sicurezza antiscivolo
- peso: 1,4 kg



1/2" PRO+ CV

BGS articolo	DESCRIZIONE
BGS 7805	IMPUGNATURA A T, CON QUADRO MASCHIO DA 1/2", LUNGHEZZA 230 MM

CARATTERISTICHE

- impugnatura ergonomica
- finitura satinata
- peso: 280 g

TOP 



1/2" 1/2"

ADATTATORE A CRICCHETTO REVERSIBILE SX/DX

Kokon articolo	D mm	L mm	
4755	33,5	65	73,87



CRICCHETTO REVERSIBILE CON QUADRO FEMMINA PASSANTE

FEFMEC articolo	M	L mm
BGS 9160	1/4"	115
BGS 312	1/2"	270
BGS 9622	3/4"	500

CARATTERISTICHE

- quadro passante
- impugnatura rivestita



1/2"

CRICCHETTO REVERSIBILE CON QUADRO MASCHIO INTERCAMBIABILE - ESTRAIBILE

attacco: 1/2"

FEFMEC articolo	L mm	
484	280	1



1/2" PRO+ CV

BGS articolo	DESCRIZIONE
BGS 314	CRICCHETTO PASSANTE CON CHIAVI SPECIALI

CARATTERISTICHE

- chiave di montaggio da 3/8" - 7/16" - 1/2" - 5/8" 13/16"
- attacco quadro da 1/2"
- finitura cromata satinata
- peso: 750 g

SET 1/2"



MECCANISMO 36 DENTI

1/2"

CRICCHETTO REVERSIBILE 36 DENTI CON PULSANTE DI BLOCCAGGIO BUSSOLA

attacco: 1/2"

FEARMEC articolo	L mm	Immagine	Quantità
483	280		1



1/2"

NUOVI CRICCHETTI REVERSIBILI A 72 DENTI CON PULSANTE DI SBLOCCAGGIO DELLA BUSSOLA ED IMPUGNATURA ERGONOMICA BI-COMPONENTE ANTISCIVOLO E FORMA OVALE

FEARMEC articolo	L mm	Immagine	Quantità
872	250		1



1/2" **PRO+**

BGS articolo	DESCRIZIONE
BGS 617	CRICCHETTO REVERSIBILE, ATT. 1/2", LUNGH. 250 MM, 72 DENTI

CARATTERISTICHE

- modello dritto
- cricchetto reversibile 72 denti
- con pulsante di sgancio rapido
- impugnatura in materiale bi-componente
- finitura: cromato satinato
- lunghezza: 250 mm
- peso: 590 g



1/2" **CV**

BGS articolo	DESCRIZIONE
BGS 2300	CRICCHETTO REVERSIBILE, ATT. 1/2", LUNGH. 240 MM

CARATTERISTICHE

- reversibile
- con impugnatura ergonomica in gomma
- lunghezza 240 mm
- peso: 470 g



1/2" **PRO+**

BGS articolo	DESCRIZIONE
BGS 620	CRICCHETTO REVERSIBILE, ATT. 1/2", LUNGH. 250 MM, 90 DENTI

CARATTERISTICHE

- cricchetto reversibile 90 denti
- con pulsante di sgancio rapido
- impugnatura in materiale bi-componente
- finitura: cromata satinata
- lunghezza: 255 mm
- peso: 560 g



1/2" **PRO+**

BGS articolo	DESCRIZIONE
BGS 632	CRICCHETTO REVERSIBILE, ATT. 1/2", LUNGH. 250 MM, 90 DENTI

CARATTERISTICHE

- cricchetto reversibile 90 denti
- con pulsante di sgancio rapido
- impugnatura in materiale bi-componente
- finitura: cromata satinata
- lunghezza: 255 mm
- peso: 560 g



1/2" **CV** **MECCANISMO 72 DENTI**

BGS articolo	DESCRIZIONE
BGS 519	CRICCHETTO REVERSIBILE, ATT. 1/2", LUNGH. 255 MM, 72 DENTI

CARATTERISTICHE

- impugnatura in materiale bi-componente
- con sgancio rapido
- lunghezza 255 mm
- peso: 570 g



XXL

1/2" **PRO+** **MECCANISMO 72 DENTI**

BGS articolo	DESCRIZIONE
BGS 324	CRICCHETTO REVERSIBILE, ATT. 1/2", LUNGH. 380 MM, 72 DENTI, EXTRA LUNGO

CARATTERISTICHE

- 72 denti
- lunghezza 380 mm
- impugnatura ergonomica antiscivolo in materiale bi-componente
- peso: 800 g

RICAMBI

BGS articolo	DESCRIZIONE
BGS 178	SET RIPARAZIONE CRICCHETTO



QUANDO MANCA LO SPAZIO

1/2" **PRO+** **CV**

BGS articolo	DESCRIZIONE
BGS 107	CRICCHETTO REVERSIBILE, AD IMPUGNATURA ROTATIVA, ATT. 1/2", LUNGH. 295 MM

CARATTERISTICHE

- dentatura fine
- reversibile
- doppia funzione:
 - ruotando l'impugnatura si ottiene un movimento rotatorio del quadro
 - azione a "cricchetto tradizionale"
- attacco quadro maschio: 1/2"
- impugnatura ergonomica
- materiale: acciaio al cromo vanadio
- finitura: cromata satinata
- lunghezza: 295 mm
- larghezza: 43 mm
- peso: 740 g

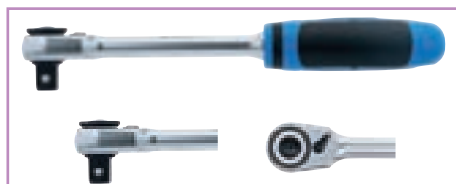

1/2" **CV** PRO+ **MECCANISMO 72 DENTI**

BGS articolo	DESCRIZIONE
BGS 612	CRICCHETTO REVERSIBILE, ATT. 1/2", LUNGH. 250 MM, 72 DENTI, "EXTRA SLIM"

CARATTERISTICHE

- cricchetto reversibile 72 denti
- modello dritto "**extra slim**"
- con pulsante di sgancio rapido
- acciaio al Cromo Vanadio
- lunghezza: 250 mm
- impugnatura in materiale bi-componente
- peso: 420 g



1/2" **PRO+**

BGS articolo	DESCRIZIONE
BGS 304	CRICCHETTO IN NYLON E FIBRA DI VETRO, ATT. 1/2", LUNGH. 255 MM, 72 DENTI

CARATTERISTICHE

- con pulsante di sgancio rapido
- comodo utilizzo grazie ai materiali ultra-leggeri, nessun affaticamento
- i test su questo attrezzo hanno ottenuto risultati per capacità massima decisamente superiori ai limiti DIN
- lunghezza: circa 255 mm
- in polipropilene rivestito in acciaio CR-V con impugnatura in materiale bi-componente
- peso: 450 g



TESTA SNODATA
1/2" **PRO+** **MECCANISMO 72 DENTI**

BGS articolo	DESCRIZIONE
BGS 114	CRICCHETTO ATT. 1/2", LUNGH. 310 MM CON TESTA SNODATA, REGOLABILE, 72 DENTI

CARATTERISTICHE

- testa snodata 180°
- finitura cromata
- cricchetto reversibile 72 denti
- con pulsante di sgancio rapido
- lunghezza 310 mm
- peso: 630 g



TESTA SNODATA 90°
1/2" **PRO+** **MECCANISMO 45 DENTI** **CV**

BGS articolo	DESCRIZIONE
BGS 287	CRICCHETTO ATT. 1/2", LUNGH. 290 MM CON TESTA SNODATA, REGOLABILE, 45 DENTI

CARATTERISTICHE

- finitura satinata cromata
- regolabili in sicurezza in 5 posizioni
- 45 denti
- con pulsante di sgancio rapido
- impugnatura con occhio
- lunghezza 290 mm
- peso: 720 g



M
PRO+ **CV** **▲1000 V** **DVE**

CRICCHETTO REVERSIBILE, ISOLATI VDE, 1000 V

BGS articolo	Nr. denti	L mm
BGS 702	1/2"	230

CARATTERISTICHE

- conformi DIN EN 60900
- isolati VDE fino a 1000 V
- con pulsante di sgancio rapido
- peso: 650 g



novità
1/2" **▲1000 V** **DVE** **PRO+**

BGS articolo	DESCRIZIONE
BGS 626	CRICCHETTO REVERSIBILE ISOLATO VDE, ATT. 1/2", 1000 V

CARATTERISTICHE

- ideale per l'utilizzo su impianti elettrici o per i lavori di riparazione e manutenzione di veicoli ibridi ed elettrici
- riduce il rischio di cortocircuiti
- ideale per elettricisti e specialisti del settore elettrico
- con pulsante di sgancio rapido
- reversibile
- conforme DIN EN/IEC 60900
- isolato VDE fino a 1000 V
- attacco quadro: 1/2"
- numero di denti: 36
- Standard DIN: EN 60900
- lunghezza: 200 mm
- materiale: acciaio al cromo vanadio
- finitura superficiale: Isolamento VDE
- impugnatura in materiale bi-componente
- peso: 770 g



novità

3 IN 1

1/4"



3/8"



1/2"

BGS
articolo

DESCRIZIONE

BGS 71015
**CRICCHETTO
REVERSIBILE, DENTE
FINE, 3 IN 1,
1/4"/ 3/8" / 1/2"**

CARATTERISTICHE

- in acciaio
- per bussole con attacco quadro 1/4", 3/8", 1/2"
- 72 denti
- tutti gli attacchi integrati in un unico profilo quadrato di uscita
- con leva di inversione
- materiale: acciaio al carbonio
- finitura: lucidatura a specchio
- lunghezza: 190 mm
- peso: 360 g



novità

ESTENSIBILI & SNODATI

1/4"



3/8"



1/2"

PRO+

CRICCHETTI REVERSIBILI ESTENSIBILI,
SNODATIBGS
articolo

DESC

DESCRIZIONE

BGS 25125

1/4"

210 - 250 MM

BGS 25126

3/8"

260 - 365 MM

BGS 25127

1/2"

350 - 490 MM

CARATTERISTICHE

- leva lunga estensibile e snodata
- bloccabile in varie posizioni mediante un anello autobloccante
- con pulsante di sgancio rapido
- impugnatura in materiale bi-componente antiscivolo ed ergonomica
- cricchetti reversibili 72 denti, snodati 180°
- attacco quadro
- materiale: acciaio al cromo vanadio
- finitura: cromata satinata



novità

ESTENSIBILE XXL

1/2"

CV

PRO+

BGS
articolo

DESCRIZIONE

BGS 25124
**CRICCHETTO
REVERSIBILE
ESTENSIBILE,
ATTACCO 1/2",
455 - 595 MM**

CARATTERISTICHE

- leva lunga estensibile e snodata
- bloccabile in varie posizioni mediante un anello autobloccante
- con pulsante di sgancio rapido
- impugnatura in materiale bi-componente antiscivolo ed ergonomica
- cricchetti reversibili 72 denti
- attacco quadro 1/2"
- materiale: acciaio al cromo vanadio
- finitura: cromata satinata
- estensibile 455 - 595 mm
- peso 1,2 kg



novità



1/2"

PRO+

BGS
articolo

DESCRIZIONE

BGS 644
**MINI-CRICCHETTO
REVERSIBILE,
ATT. 1/2",
LUNGH. 170 MM,
EXTRA CORTO**

CARATTERISTICHE

- design compatto
- reversibile
- con pulsante di sgancio rapido
- attacco quadro maschio: 1/2"
- numero di denti testa del cricchetto: 90
- impugnatura in materiale bi-componente antiscivolo ed ergonomica
- materiale: acciaio al cromo vanadio
- finitura: cromata satinata
- lunghezza: 170 mm
- peso: 490 g

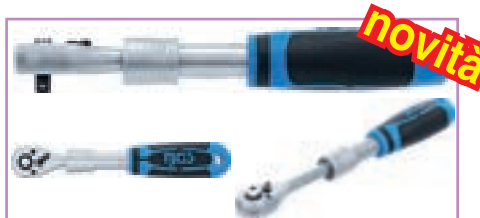

novità

ESTENSIBILI

1/4"



3/8"



1/2"

CV

PRO+

CRICCHETTI REVERSIBILI ESTENSIBILI

BGS
articolo

DESC

DESCRIZIONE

BGS 25120

1/4"

190 - 225 MM

BGS 25121

3/8"

240 - 345 MM

BGS 25122

1/2"

305 - 445 MM

CARATTERISTICHE

- leva lunga estensibile e snodata
- bloccabile in varie posizioni mediante un anello autobloccante
- con pulsante di sgancio rapido
- impugnatura in materiale bi-componente antiscivolo ed ergonomica
- cricchetti reversibili 72 denti
- attacco quadro
- materiale: acciaio al cromo vanadio
- finitura: cromata satinata

MECCANISMO
72
DENTI

BGS 304-1

BGS
articolo

DESCRIZIONE

BGS 304
**CRICCHETTO IN NYLON
E FIBRA DI VETRO,
ATT. 1/2",
LUNGH. 255 MM,
72 DENTI**

CARATTERISTICHE

- con pulsante di sgancio rapido
- comodo utilizzo grazie ai materiali ultra-leggeri, nessun affaticamento
- i test su questo attrezzo hanno ottenuto risultati per capacità massima decisamente superiori ai limiti DIN
- lunghezza: circa 255 mm
- in polipropilene rivestito in acciaio CR-V con impugnatura in materiale bi-componente
- peso 450 g

RICAMBI

BGS
articolo

DESCRIZIONE

BGS 304-1
**novità SET RIPARAZIONE
CRICCHETTO**



EXTRA-LUNGHE



BGS 635-REPAIR BGS 636-REPAIR BGS 637-REPAIR

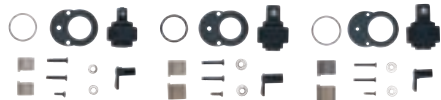

CRICCHETTI REVERSIBILI, EXTRA LUNGHI

BGS articolo	LUNGHEZZA mm
BGS 635	1/4" 300
BGS 636	3/8" 455
BGS 637	1/2" 605

CARATTERISTICHE

- sforzo ridotto grazie alla leva più lunga
- dritte
- 72 denti
- con pulsante di sgancio rapido
- con cricchetto reversibile
- attacco quadro maschio
- impugnatura in materiale bi-componente
- materiale: acciaio al cromo vanadio
- finitura: cromato satinato

RICAMBI

BGS articolo	DESCRIZIONE
BGS 635-REPAIR	PER BGS 635 & BGS 638
BGS 636-REPAIR	PER BGS 636 & BGS 639
BGS 637-REPAIR	PER BGS 637 & BGS 640



SNODATE



BGS 635-REPAIR BGS 636-REPAIR BGS 637-REPAIR



CRICCHETTI REVERSIBILI, EXTRA LUNGHI

BGS articolo	LUNGHEZZA mm
BGS 638	1/4" 304
BGS 639	3/8" 457
BGS 640	1/2" 609

CARATTERISTICHE

- testa a cricchetto snodata 180°
- sforzo ridotto grazie alla leva più lunga
- dritte
- 72 denti
- con pulsante di sgancio rapido
- con cricchetto reversibile
- attacco quadro maschio
- impugnatura in materiale bi-componente
- materiale: acciaio al cromo vanadio
- finitura: cromato satinato

RICAMBI

BGS articolo	DESCRIZIONE
BGS 635-REPAIR	PER BGS 635 & BGS 638
BGS 636-REPAIR	PER BGS 636 & BGS 639
BGS 637-REPAIR	PER BGS 637 & BGS 640



ESTENSIBILI & SNODATI



BGS articolo	DESCRIZIONE
BGS 25128	SET 3 PEZZI, CRICCHETTI REVERSIBILI ESTENSIBILI, SNODATI, ATTACCO 1/4" - 3/8" - 1/2"

CARATTERISTICHE

- leva lunga estensibile e snodata
- bloccabile in varie posizioni mediante un anello autobloccante
- con pulsante di sgancio rapido
- impugnatura in materiale bi-componente antiscivolo ed ergonomica
- cricchetti reversibili 72 denti, snodati 180°
- attacco quadro
- materiale: acciaio al cromo vanadio
- finitura: cromata satinata
- comprende:
 - 1 cricchetto reversibile, estensibile, snodato, attacco 1/4", 210 - 250 mm (BGS 25125)
 - 1 cricchetto reversibile, estensibile, snodato, attacco 3/8", 260 - 365 mm (BGS 25126)
 - 1 cricchetto reversibile, estensibile, snodato, attacco 1/2", 350 - 490 mm (BGS 25127)
- peso 2,7 kg



SET 1/2"



novità

ESTENSIBILI

BGS articolo	DESCRIZIONE
BGS 25123	SET 3 PEZZI, CRICCHETTI REVERSIBILI ESTENSIBILI, ATTACCO 1/4" - 3/8" - 1/2"

CARATTERISTICHE

- leva lunga estensibile e snodata
- bloccabile in varie posizioni mediante un anello autobloccante
- con pulsante di sgancio rapido
- impugnatura in materiale bi-componente antiscivolo ed ergonomica
- cricchetti reversibili 72 denti
- attacco quadro
- materiale: acciaio al cromo vanadio
- finitura: cromata satinata
- comprende:
 - 1 cricchetto reversibile, estensibile, attacco 1/4", 190 - 225 mm (BGS 25120)
 - 1 cricchetto reversibile, estensibile, attacco 3/8", 240 - 345 mm (BGS 25121)
 - 1 cricchetto reversibile, estensibile, attacco 1/2", 305 - 445 mm (BGS 25122)
- peso 2,5 kg



novità

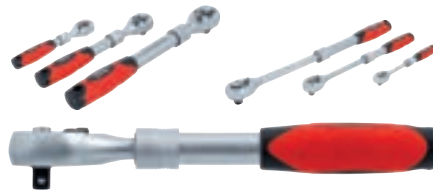

1/4" 3/8" 1/2"

ESTENSIBILI

BGS articolo	DESCRIZIONE
BGS 72113	SET 3 PEZZI, CRICCHETTI REVERSIBILI ESTENSIBILI, ATTACCO 1/4" - 3/8" - 1/2"

CARATTERISTICHE

- braccio di leva lungo e telescopico per applicare facilmente coppie elevate
- bloccabile in varie fasi mediante anello autoserrante
- con sgancio rapido
- impugnatura in materiale bi-componente antiscivolo ed ergonomica
- 72 denti
- cricchetti reversibili con leva di inversione
- quadro con sfera di bloccaggio
- materiale: acciaio al cromo vanadio
- finitura: cromata satinata
- comprende:
 - 1 cricchetto reversibile estensibile, attacco 1/4", regolabile in 4 lunghezze, lunghezza massima 200 mm
 - 1 cricchetto reversibile estensibile, attacco 3/8", regolabile in 5 lunghezze, lunghezza massima 320 mm
 - 1 cricchetto reversibile estensibile, attacco 1/2", regolabile in 6 lunghezze, lunghezza massima 445 mm
- peso: 2,7 kg

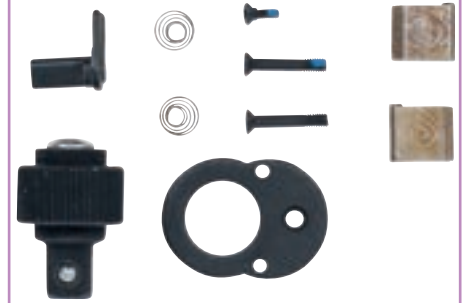

novità

KIT DI RIPARAZIONE PER TESTA A CRICCHETTO

BGS articolo	
BGS 72115	1/4"
BGS 72116	3/8"
BGS 72117	1/2"

CARATTERISTICHE

- tutte le parti di usura per la testa del cricchetto in un unico set
- per BGS 72113 e BGS 72114

MECCANISMO
72
DENTI

BGS articolo	DESCRIZIONE
BGS 215	SET 3 PEZZI, CRICCHETTI REVERSIBILI COMPATTI 1/4"-3/8"-1/2"

CARATTERISTICHE

- formato extra-small per spazi ridotti e angusti
- 72 denti
- lunghezza cricchetti:
 - attacco 1/4": 110 mm
 - attacco 3/8": 140 mm
 - attacco 1/2": 170 mm
- peso: 1,2 kg



1/4" - 3/8" - 1/2"



PRO+

BGS articolo	DESCRIZIONE
BGS 621	SET 3 PEZZI, CRICCHETTI REVERIBILI, 1/4"-3/8"-1/2"

CARATTERISTICHE

- impugnatura ergonomica antiscivolo in materiale bi-componente
- stelo sfasato
- con pulsante di sgancio rapido
- cricchetto reversibile 72 denti
- lunghezza:
 - cricchetto reversibile attacco 1/4" (BGS 618): 150 mm
 - cricchetto reversibile attacco 3/8" (BGS 619): 200 mm
 - cricchetto reversibile attacco 1/2" (BGS 620): 250 mm
- peso: 1,4 kg

RICAMBI

BGS articolo	DESCRIZIONE
BGS 618	CRICCHETTO REVERIBILE, ATTACCO 1/4"
BGS 618-1	SET RIPARAZIONE CRICCHETTO, ATTACCO 1/4"
BGS 619	CRICCHETTO REVERIBILE, ATTACCO 3/8"
BGS 619-1	SET RIPARAZIONE CRICCHETTO, ATTACCO 3/8"
BGS 620	CRICCHETTO REVERIBILE, ATTACCO 1/2"
BGS 620-1	SET RIPARAZIONE CRICCHETTO, ATTACCO 1/2"



1/2"



PRO+

BGS articolo	DESCRIZIONE
BGS 6425	SET 9 PEZZI, BUSSOLE TORX, ATT. 1/2"

CARATTERISTICHE

- E10-11-12-14-16-18-20-22-24
- finitura satinata cromata
- peso: 860 g



1/4"



3/8"



1/2"



PRO+

BGS articolo	DESCRIZIONE
BGS 70099	SET 28 PEZZI, BUSSOLE TORX FEMMINA, E4 - E20, ATT. 1/4" - 3/8" - 1/2"

CARATTERISTICHE

- zigrinato
- finitura cromata satinata
- impronta Torx Femmina
- comprende:
 - attacco 1/4": E4 - E5 - E6 - E7 - E8 - E10 - E11 - E12 - E14 - E16 - E18 - E20
 - attacco 3/8": E4 - E5 - E6 - E7 - E8 - E10 - E11 - E12 - E14 - E16 - E18 - E20
 - attacco 1/2": E4 - E5 - E6 - E7 - E8 - E10 - E11 - E12 - E14 - E16 - E18 - E20
- peso: 1,3 kg



1/2"



TORX TORX

- 9 BUSSOLE TORX® FEMMINA**
- E 10-11-12-14-16-18-20-22-24
- 10 BUSSOLE CON INSERTI TORX®**
- T 20-25-27-30-40-45-50-55-60-70

attacco: 1/2"

impronta: TORX®

BGS articolo	Descrizione	
54019	CASSETTA PLASTICA 19 PEZZI	1



1/2"



PRO+



TORX TORX

BGS articolo	DESCRIZIONE
BGS 5100	SET 19 PEZZI, BUSSOLE TORX FEMMINA E BUSSOLE CON INSERTI TORX, ATT. 1/2"

CARATTERISTICHE

- comprende:
 - bussole Torx femmina, att.. 1/2": E10, E11, E12, E14, E16, E18, E20, E22, E24
 - bussole con inserti Torx, att. 1/2": TX20, TX25, TX27, TX30, TX40, TX45, TX50, TX55, TX60, TX70
- finitura cromata satinata
- peso: 1,8 kg

RICAMBI

BGS articolo	DESCRIZIONE
BGS 5100-LEER	CASSETTA VUOTA

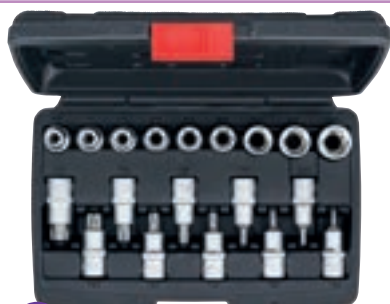

BGS articolo	DESCRIZIONE
BGS 95100	SET 19 PEZZI, BUSSOLE TORX FEMMINA E BUSSOLE CON INSERTI TORX, ATT. 1/2"

CARATTERISTICHE

- comprende:
 - bussole Torx femmina, att.. 1/2": E10, E11, E12, E14, E16, E18, E20, E22, E24
 - bussole con inserti Torx, att. 1/2": TX20, TX25, TX27, TX30, TX40, TX45, TX50, TX55, TX60, TX70
- finitura cromata satinata
- peso: 1,7 kg



BGS articolo	DESCRIZIONE
BGS 5101	SET 27 PEZZI, INSERTI E CHIAVI A BUSSOLA TORX, ATT. 1/2"

CARATTERISTICHE

- conformi DIN
- 5 chiavi a bussola attacco da 1/2" T45-50-55-60-70
- 7 inserti per viti Torx Tx10-15-20-25-27-30-40
- 12 inserti Torx c/foro: Th10-15-20-25-27-30-40-45-50-55-60-70
- 3 adattatori per inserti attacco da 1/4" - 3/8 - 1/2"
- peso: 960 g



FERMEC articolo	DESCRIZIONE
2271	SET 72 PEZZI, UTENSILI TORX, ATT. 1/4" - 1/2"

CARATTERISTICHE

- bussole torx femmina:
 - att. 1/4": E4 - E5 - E6 - E7 - E8 - E10 - E11
 - att. 1/2": E12 - E14 - E16 - E18 - E20 - E22 - E24
- chiavi a bussola Torx, att. 1/4": TX10 - TX15 - TX20 - TX25 - TX27 - TX30
- inserti att. 10 mm, lunghezza 30 mm, Torx c/ foro: TH40 - TH45 - TH50 - TH55 - TH60 - TH70
- inserti att. 10 mm, lunghezza 75 mm, Torx: TX15 - TX20 - TX25 - TX30 - TX40 - TX45 - TX50 - TX55 - TX60
- inserti att. 1/4", lunghezza 25 mm:
 - Torx: TX7 - TX8 - TX9
 - Torx con foro: TH10 - TH15 - TH20 - TH25 - TH27 - TH30 - TH40
- Chiave Torx tipo L: TX8 - TX10 - TX15 - TX20 - TX25 - TX27 - TX30 - TX40 - TX45 - TX50 - TX55 - TX60
- cacciaviti Torx: TX8 - TX10 - TX15 - TX20 - TX25 - TX27 - TX30 - TX40
- chiavi doppio anello: E6 x E8 - E10 x E12 - E14 x E18 - E20 x E24
- adattatori
 - portainseriti esag. fem. 1/4" - quadro fem.1/4"
 - portainseriti esag. fem. 10 mm- quadro fem.1/2"
- utensile di raccolta magnetico

TORX®

	S mm	S mm	
E 4	3.70	E 16	14.60
E 5	4.60	E 18	16.50
E 6	5.60	E 20	18.30
E 7	6.10	E 22	20.10
E 8	7.40	E 24	22.00
E 10	9.30	E 26	23.70
E 11	9.90	E 28	25.50
E 12	11.00	E 30	27.30
E 14	12.80	E 32	29.00



BGS articolo	DESCRIZIONE
BGS 7849	SET 84 PEZZI, UTENSILI TORX, ATT. 1/4" - 1/2"

CARATTERISTICHE

- utensili attacco 1/2":
 - bussole: E12 - E14 - E16 - E18 - E20 - E22 - E24
 - adattatore portainseriti attacco 10 mm
 - adattatore portainseriti attacco 14 mm
- utensili att. 1/4":
 - bussole: E4 - E5 - E6 - E7 - E8 - E10 - E11
 - chiavi a bussola att. 1/4", lunghezza 37 mm
 - Torx: TX10 - TX15 - TX20 - TX25 - TX27 - TX30
 - adatt. portainseriti att. 1/4"
- inserti attacco 10 mm, lunghezza 30 mm, Torx con foro: TH40 - TH45 - TH50 - TH55 - TH60 - TH70
- inserti att. 10 mm, lunghezza 75 mm, Torx: TX15 - TX20 - TX25 - TX30 - TX40 - TX45 - TX50
- inserti attacco 14 mm:
 - lunghezza 40 mm, Torx c/foro: TX80-TX90-TX100
 - lunghezza 75 mm, Torx: TX55 - TX60
- inserti attacco 1/4"esagonale:
 - lunghezza 25 mm, 5 punte con foro: TS7-TS8-TS9
 - lunghezza 25 mm, Torx con foro: TH10-TH15-TH20 - TH25 - TH27 - TH30 - TH40
 - Torx con foro: TX10 - TX15-TX20-TX25-TX27-TX30 - TX40 - TX45
- Chiave Torx tipo L: TX8 - TX10 - TX15 - TX20 - TX25 - TX27 - TX30 - TX40 - TX45 - TX50 - TX55 - TX60
- chiavi doppio anello: E6 x E8, E10 x E12, E14 x E18, E20 x E24
- cacciavite Torx con foro: TH8 - TH10 - TH15 - TH20 - TH25 - TH27 - TH30 - TH40
- asta magnetica telescopica
- peso: 4,6 kg



BGS articolo	DESCRIZIONE
BGS 2224	SET 27 PEZZI, BUSSOLE , 8-32 MM, ATT. 1/2"

CARATTERISTICHE
<ul style="list-style-type: none"> • conformi DIN • bussole esagonali • cricchetto reversibile da 72 denti • 2 prolunghe testa sferica: 125 + 250 mm • 1 quadro scorrevole per prolunghe • 1 snodo • 2 bussole per candele: 16 + 21 mm • 20 bussole esagonali: 8-9-10-11-12-13-14-15-16-17-18-19-20-21-22-23-24-27-30-32 mm • peso: 4,1 kg

RICAMBI	
BGS articolo	DESCRIZIONE
BGS 2224-LEER	CASSETTA VUOTA



**BUSSOLE
ESAGONALI**



BGS articolo	DESCRIZIONE
BGS 9192	SET 2 CASSETTE, 174 CHIAVI A BUSSOLA ESAGONALI MISURE IN POLLICI, ATT. 1/4" - 1/2"

CARATTERISTICHE
<ul style="list-style-type: none"> • comprende due set attacco 1/4" e 1/2" • comprende i seguenti utensili attacco 1/4": <ul style="list-style-type: none"> - cricchetto reversibile, 72 denti, con pulsante di sgancio rapido - prolunga, 50 mm - leva con quadro scorrevole - impugnatura 150 mm - bussole esagonali in pollici: 5/32-3/16-7/32-1/4-9/32-5/16-11/32-3/8-13/32-7/16-15/32-1/2-9/16" - 1 adattatore portainseri 1/4" esagonale - inserti attacco esagonale 1/4", lunghezza 50 mm: PZ1-PZ2 - Taglio 4 e 6 mm - inserto speciale per viti a occhiello - inserti esagonali in pollici, attacco 1/4": 1/16"-5/64"-3/32"-7/64"-1/8"-9/64"-5/32"-3/16"-7/32"-1/4" - inserti esagonali con foro in pollici, attacco 1/4": 5/64"-3/32"-7/64"-1/8"-9/64"-5/62" - inserti esagonali metrici, attacco 1/4": 1.5-2-2.5-3-4-5-5.5-6-8 mm - inserti esagonali metrici con foro, attacco 1/4": 2-2.5-3-4-5-6 mm - inserti spanner, attacco 1/4": 4-6-8-10 mm - inserti Torx, attacco 1/4": TX8-TX10-TX15-TX20-TX25-TX27-TX30-TX35-TX40 - inserti Torx con foro, attacco 1/4": TH8-TH10-TH15-TH20-TH25-TH27-TH30-TH35-TH40 - inserti xzn, attacco 1/4": 5-6-8 - inserti Quadro, attacco 1/4": S0-S1-S2-S3 - inserti PZ, attacco 1/4": PZ0-PZ0-PZ1-PZ1-PZ2-PZ2-PZ2-PZ2-PZ3-PZ3 - inserti PH, attacco 1/4": PH0-PH0-PH1-PH1-PH2-PH2-PH2-PH3-PH3 - inserti Taglio, attacco 1/4": 3-4-4.5-5-5.5-6-6.5-7-8 mm - inserti a due tacche, attacco 1/4": C1-C2-C3 - inserti Tri-wing, attacco 1/4": 1-2-3-4-6-8-10 - chiavi a L esagonali: 1-1.5-2-2.5-3-4-5 mm • comprende i seguenti utensili attacco 1/2": <ul style="list-style-type: none"> - cricchetto reversibile, 72 denti, con pulsante di sgancio rapido - prolunghe: 125, 200 mm - adattatore quadro scorrevole per uso come leva a T - snodo - bussole esagonali in pollici: 3/8"-7/16"-15/32"-1/2"-9/16"-19/32"-5/8"-11/16"-23/32"-3/4"-7/8" 15/16"-1.1/16"-1.3/16"-1.1/4" - inserti attacco 5/16" (8 mm): - PH3-PH4 / PZ3-PZ4 - Taglio: 8-10-12 - Torx: TX40-TX45-TX50-TX55-TX60 - Torx con foro: TH40-TH45-TH50-TH55-TH60 - XZN: M8-M10-M12 - Esagono: 7-8-10-12 mm • peso: 5,7 kg

SET 0 1/2"



novità

POLLICI

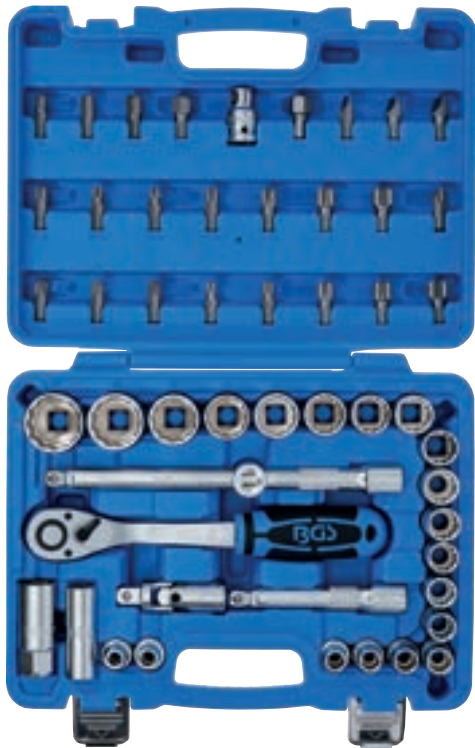
 BUSSOLE
 POLIGONALI

 CV
 S2

PRO+

 BGS
 articolo

DESCRIZIONE

BGS 74509

SET 51 PEZZI, BUSSOLE POLIGONALI, ATTACCO 1/2", 8 - 32 MM

CARATTERISTICHE

- con bussole poligonali
- cricchetto reversibile con 90 denti, impugnatura ergonomica in materiale bi-componente e pulsante di sgancio rapido
- in valigetta in plastica
- bussole zigrinate
- bussole, prolunghe, cricchetto reversibile, giunto universale e adattatore portainseriti in acciaio al cromo vanadio
- inserti in acciaio al cromo vanadio di alta qualità (S2)
- attacco quadro femmina: 1/2"
- materiale: acciaio al cromo vanadio
- finitura: cromata satinata
- comprende:
 - bussole poligonali, attacco 1/2":
8 mm (BGS 10628), 9 mm (BGS 10629), 10 mm (BGS 10630), 11 mm (BGS 10631), 12 mm (BGS 10632), 13 mm (BGS 10633), 14 mm (BGS 10634), 15 mm (BGS 10635), 16 mm (BGS 10636), 17 mm (BGS 10637), 18 mm (BGS 10638), 19 mm (BGS 10639), 20 mm (BGS 10640), 21 mm (BGS 10641), 22 mm (BGS 10642), 23 mm (BGS 10643), 24 mm (BGS 10644), 27 mm (BGS 10645), 30 mm (BGS 10646), 32 mm (BGS 10647)
 - bussole per candele, esagonali, attacco 1/2": 16 mm (BGS 2472), 21 mm (BGS 2470)
 - adattatore scorrevole prolunghe, attacco quadro 1/2" (BGS 289)
 - snodo, attacco 1/2" (BGS 251)
 - prolunghe, attacco 1/2": 125 mm (BGS 234), 250 mm (BGS 235)
 - cricchetto reversibile, attacco 1/2" (BGS 632)
 - adattatore portainseriti, attacco quadro femmina 1/2", esagono femmina 5/16" (BGS 293)
 - inserti, attacco esagonale 5/16", Esagonali: 7 mm (BGS 4387), 8 mm (BGS 4388), 10 mm (BGS 4389), 12 mm (BGS 4390), 14 mm (BGS 4391)
 - inserti, attacco esagonale 5/16", Taglio: 8 mm (BGS 4380), 10 mm (BGS 4381), 12 mm (BGS 4382)
 - inserti, attacco esagonale 5/16", Torx con foro: TH40 (BGS 4440), TH45 (BGS 4445), TH50 (BGS 4450), TH55 (BGS 4455), TH60 (BGS 4460), TH70 (BGS 4458)
 - inserti, attacco esagonale 5/16", PH: PH3 (BGS 4383), PH4 (BGS 4384)
 - inserti, attacco esagonale 5/16", PZ: PZ3 (BGS 4385), PZ4 (BGS 4386)
 - inserti, attacco esagonale 5/16", Torx: TX40 (BGS 8164), TX45 (BGS 8165), TX50 (BGS 8166), TX55 (BGS 8168), TX60 (BGS 4456), TX70 (BGS 4457)
- peso: 4,5 Kg



1/2"

CV

PRO+



ESAGONO

 BGS
 articolo

DESCRIZIONE

BGS 2216

 SET 27 PEZZI,
 BUSSOLE IN POLLICI,
 ATT. 1/2"

CARATTERISTICHE

- conformi DIN
- bussole esagonali
- cricchetto reversibile da 72 denti
- 2 prolunghe testa sferica: 125 + 250 mm
- 1 quadro scorrevole per prolunghe
- 2 bussole per candele: 5/8" + 13/16"
- 20 bussole esagonali: 5/16" - 11/32" - 3/8" - 7/16" - 15/32" - 1/2" - 9/16" - 19/32" - 5/8" - 21/32" - 11/16" - 3/4" - 25/32" - 13/16" - 7/8" - 15/16" - 1" - 1 1/16" - 1 3/16" - 1 1/4"
- peso: 4,2 kg

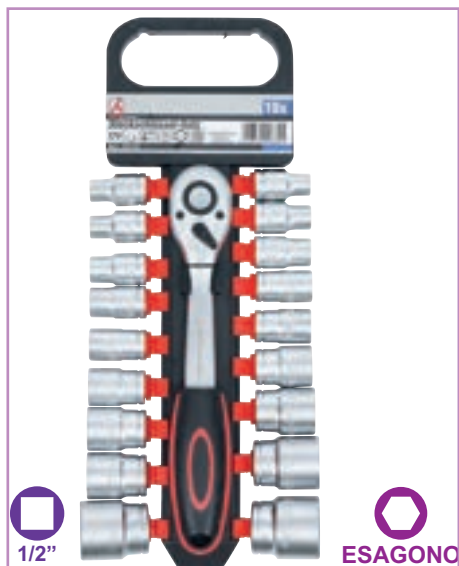

1/2" ESAGONO



BGS articolo	DESCRIZIONE
BGS 15110	SET 19 PEZZI, CRICCHETTO E BUSSOLE, ATT. 1/2"

CARATTERISTICHE	
<ul style="list-style-type: none"> • cricchetto reversibile attacco 1/2" • 18 bussole esagonali attacco quadro 1/2": 8 - 9 - 10 - 11 - 12 - 13 - 14 - 15 - 16 - 17 - 19 - 21 - 22 - 23 - 24 - 27 - 30 - 32 mm • con supporto in plastica • peso: 2,3 kg 	



BUSSOLE MULTIMPRONTA SPLINE DRIVE

1/2" BUSSOLE MULTIMPRONTA MULTIMPRONTA SPLINE DRIVE

CASSETTA BUSSOLE MULTIMPRONTA ATTACCO 1/2" ADATTE PER DADI ESAGONALI POLIGONALI - POLLICI QUADRI - XZN® - TORX® PEZZI 42 DA 10-32 MM + INSERTI XZN, ESAGONO E TORX

Descrizione	
FRM 4422 VALIGETTA 42 PEZZI	1



3/8" ESAGONO CV S2 CV PRO+

BGS articolo	DESCRIZIONE
BGS 9366	SET 44 PEZZI, BUSSOLE PASSANTI

CARATTERISTICHE	
<ul style="list-style-type: none"> • ideale per avvitare dadi con fuoriuscita del filetto • materiale: <ul style="list-style-type: none"> - bussole in acciaio Chrome-Vanadium - inserti in acciaio Chrome-Vanadium S2 • comprende: <ul style="list-style-type: none"> - cricchetto passante, 72 denti, misura interna 12 mm - bussole esagonali passanti, attacco speciale 12 mm: 6-7-8-9-10-11-12-13-14 mm - adattatore attacco speciale 12 mm-quadro maschio 3/8" - 33 inserti in acciaio S2, attacco speciale 12 mm <ul style="list-style-type: none"> - XZN: M4 - M5 - M6 - M8 - M10 - M12 - RIBE: M5 - M6 - M7 - M8 - M10 - M12 - M13 - Torx: TX15-TX20-TX25-TX27-TX30-TX40-TX45 - Torx c/Foro: TH15-TH20-TH25-TH27-TH30-TH40-TH45 - Esagonali: 4 - 5 - 6 - 7 - 8 - 10 mm • peso: 1,2 kg 	



novità

BGS articolo	DESCRIZIONE
BGS 74419	SET 28 PEZZI, UTENSILI PER AMMORTIZZATORI

CARATTERISTICHE	
<ul style="list-style-type: none"> • per la manutenzione di puntoni delle sospensioni, ammortizzatori, cuscinetti dei puntoni delle sospensioni, le molle elicoidali delle sospensioni • per qualsiasi intervento di riparazione sugli ammortizzatori e per il bloccaggio del pistone dell'ammortizzatore • per i tipi di veicoli più comuni • è indispensabile rispettare i valori di coppia di serraggio del costruttore del veicolo • materiale: acciaio al cromo-vanadio • comprende: <ul style="list-style-type: none"> - 1 cricchetto poligonale, passante, 21 mm - 6 bussole, esagonali, lunghe, att. 1/2" & esagonale 21 mm, 16 - 17 - 18 - 19 - 21 - 22 mm - 1 quadro scorrevole, attacco 3/8" - 4 bussole, profilo speciale ovale, attacco 1/4", 5 - 6 - 7 - 7,5 mm - 4 bussole, esagonali, attacco 1/4", 8 - 9 - 10 - 11 mm - 4 inserti, attacco esagonale 5/16", esagonali, 5 - 6 - 7 - 8 mm - 4 bussole per morsetti per puntoni a molla, attacco 1/4", 10 - 11 - 12 - 13 mm - 1 prolunga, quadro femmina 3/8", quadro maschio 1/4" - 1 bussola, esagonale, azionamento 12,5 mm (1/2") ed esagono esterno 21 mm, 22 mm - 1 adattatore portainseri, attacco quadro femmina 1/4" - esagono femmina 5/16" - 1 chiave ad anello push fit, 21 mm, attacco rettangolare 9 x 12 mm • peso: 3,0 kg 	



SET 1/2"



BGS 2181-1

BGS 2181-2

BGS 2181-3

**BUSSOLE
MULTIMPRONTA**

CV

PRO+

articolo

DESCRIZIONE

BGS 2181

SET 52 PEZZI, BUSSOLE PASSANTI MULTIMPRONTA, 4,5 - 25 MM
CARATTERISTICHE

- particolarmente adatto per avvitare dadi con fuoriuscita del filetto
- non limitata la profondità come nelle normali bussole
- utensili con attacco esagonale da 13 mm:
 - cricchetto passante, 72 denti, esagono femmina da 13 mm
 - prolunga, 75 mm, con foro passante
 - 11 bussole multimpronta, lunghezza 25 mm: 4,5-5-5,5-6-7-8-9-10-11-12-13 mm
 - adattatore esagono maschio 13 mm - quadro maschio 1/4"
 - adattatore esagono maschio 13 mm - quadro maschio 1/4", per uso con prolunga con foro passante
 - adattatore portainseriti, esagono maschio 13 mm - esagono femmina 1/4", permette l'uso del cricchetto come cricchetto portainseriti 1/4" standard
- utensili con attacco esagonale da 19 mm:
 - cricchetto passante, 72 denti, esagono femmina da 19 mm
 - prolunga, 75 mm, con foro passante
 - 11 bussole multimpronta, lunghezza 30 mm: 8-10-11-12-13-14-15-16-17-18-19 mm
 - adattatore esagono maschio 19 mm - quadro maschio 3/8"
 - adattatore esagono maschio 19 mm - quadro maschio 3/8", per uso con prolunga con foro passante
- utensili con attacco esagonale da 22 mm:
 - cricchetto passante, 72 denti, esagono femmina da 22 mm
 - prolunga, 75 mm, con foro passante
 - 7 bussole multimpronta, lunghezza 40 mm: 19-20-21-22-23-24-25 mm
 - adattatore esagono maschio 22 mm - quadro maschio 1/2"
 - adattatore esagono maschio 22 mm - quadro maschio 1/2", per uso con prolunga con foro passante
- 10 inserti con attacco esagonale 1/4":
 - Taglio: 4 e 5 mm
 - PH1 e PH2
 - Torx: Tx10 - Tx15 - Tx20
 - Esagono: 4 - 5 - 6 mm
- peso: 3,5 kg

RICAMBI

articolo

DESCRIZIONE

BGS 2181-1 **CRICCHETTO PASSANTE 13 MM**BGS 2181-2 **CRICCHETTO PASSANTE 19 MM**BGS 2181-3 **CRICCHETTO PASSANTE 22 MM**

articolo

DESCRIZIONE

BGS 2199

**SET 23 PEZZI,
UTENSILI ASSORTITI**
CARATTERISTICHE

- 1 seghetto a mano con lama 150 mm
- 1 Martello 300 gr. DIN 1041
- 1 rotolo nastro isolante
- chiave a rullino 150 mm
- 2 cacciaviti di precisione: Taglio 2,4 mm, Phillips PH 0
- 2 cacciaviti Taglio 5,5x125 mm; 6,5x125 mm
- 1 cacciavite tester
- 3 cacciaviti Phillips: no. 1x80 mm; no. 2x100 mm; no. 3x125 mm
- 8 chiavi esagonali a L 1,5 - 6 mm
- 1 pinza 165 mm
- 1 pinza regolabile 240 mm
- 1 flessometro 3 m
- in custodia rigida in tela richiudibile con zip
- peso: 2,3 kg

CUSTODIA VUOTA

PRO+

articolo

DESCRIZIONE

BGS 3314

**CUSTODIA VUOTA PER
ATTREZZI, 15 TASCHE**
CARATTERISTICHE

- vendita senza attrezzi
- dimensioni 660 x 320 mm
- peso: 240 g



PRO +

BGS
articolo

DESCRIZIONE

BGS 3319

**CUSTODIA DA CINTURA
VUOTA PER ATTREZZI
IN TESSUTO**

CARATTERISTICHE

- vendita senza attrezzi
- asola per martello
- 7 tasche di varie misure
- peso: 140 g



BGS
articolo

DESCRIZIONE

BGS 35850

**TROUSSE PER
ELETTRICISTI,
CON 4 UTENSILI VDE
+ FORBICE**

CARATTERISTICHE

- comprende:
 - custodia da cintura vuota per attrezzi, in tessuto, BGS 3319
 - cacciavite isolato vde, Ph1, BGS 4926
 - cacciavite isolato vde, Ph2, BGS 4927
 - cacciavite isolato vde, Taglio 4,0 mm, BGS 4924
 - pinze profess. isolate vde, 180 mm, BGS 7150
 - forbici da elettricista in acciaio inox, 145 mm, BGS 7963



PESO
**10
KG**



BGS
articolo

DESCRIZIONE

BGS 6056

**CASSETTA PORTA ATTREZZI IN LAMIERA, 5 SCOMPARTI,
CON 86 UTENSILI**

CARATTERISTICHE

- cassetta in lamiera d'acciaio
- con 2 maniglie
- finitura alta resistenza
- 5 scomparti
- moduli in EVA a 2 componenti
- numero di scomparti: 5
- 4 scomparti, dimensioni interne: 460 x 95 x 45 mm
- 1 scomparto, dimensioni interne: 455 x 190 x 30 mm
- dimensioni moduli in EVA:
 - 4 moduli: 455 x 95 x 30 mm
 - 1 moduli: 455 x 190 x 30 mm
- comprende:
 - set di bussole, 1/4" (6,3 mm), 1/2" (12,5 mm), 37 pezzi
 - utensili attacco 1/4": 12 bussole esagonali (4 - 13 mm), 1 cricchetto reversibile, 10 bussole esagonali lunghe (4 - 13 mm), 1 prolunga (50 mm), 1 adattatore 1/4" quadro femmina - 1/4" esagonale femmina, impugnatura 170 mm
 - utensili attacco 1/2": 17 bussole esagonali (10 - 32 mm), 1 cricchetto reversibile, 2 prolunga (125 - 250 mm), 1 adattatore quadro scorrevole, 1 snodo
 - set 20 pezzi, inserti attacco 1/4", lunghezza 25 mm
 - set 9 chiavi a "L", esagonali, 1,5 - 10 mm
 - set 5 pezzi, cacciaviti
 - set 10 pezzi, chiavi combinate, 6 - 19 mm
 - set 3 pezzi, pinze
 - flessometro, 18 mm x 5 m
- peso 10,3 kg

RICAMBI

BGS
articolo

DESCRIZIONE

BGS 6056-1 novità

**CASSETTA PORTA ATTREZZI IN LAMIERA,
5 SCOMPARTI, VUOTA**



novità

137 UTENSILI

PRO+

CV

BGS
 articolo

DESCRIZIONE
BGS 3340
CASSETTA PORTA ATTREZZI IN LAMIERA, 5 SCOMPARTI, CON ASSORTIMENTO 137 UTENSILI
CARATTERISTICHE

- valigetta per utensili in lamiera d'acciaio, verniciato blu martello all'interno e all'esterno
- con maniglia pieghevole per il trasporto
- funzione di chiusura automatica tirando su la maniglia di trasporto
- pieghevole: con robuste cerniere rivettate
- con foro sul coperchio per chiusura con lucchetto
- dimensioni cassetta: 530 x 200 x 200 mm
- bussole, prolunga, cricchetto reversibile, pinze e chiavi combinate in acciaio al cromo vanadio
- finitura: cromata satinata
- cacciaviti e inserti in acciaio al cromo vanadio di alta qualità (S2)
- inserti colorati: un colore per ogni impronta
- comprende:
 - 1 cassetta in metallo, 530 x 200 x 200 mm, 5 scomparti (BGS 33002)
 - pinze per anelli di sicurezza seeger: per anelli esterni, piegata, 175 mm (BGS 447-1) - per anelli interni, piegata, 175 mm (BGS 447-4)
 - pinze per anelli esterni, dritta, 175 mm (BGS 447-3), per anelli interni, dritta, 175 mm (BGS 447-2)
 - 1 tenaglia da ferraio, DIN ISO 9242A, 250 mm (BGS 556)
 - 1 pinze regolabili, con impugnatura rivestita, max. 30 mm (BGS 1442)
 - 1 scalpello, 235 mm (BGS 1640)
 - punzoni, lunghezza 150 mm: 3 mm (BGS 1651-3), 4 mm (BGS 1651-4), 5 mm (BGS 1651-5), 6 mm (BGS 1651-6), 7 mm (BGS 1651-7), 8 mm (BGS 1651-8)
 - 1 calibro digitale, 150 mm (BGS 1930)
 - 1 tester, 6 - 24 V (BGS 2072)
 - 1 spazzola manuale, in filo d'acciaio, 5 file, 300 mm (BGS 3073)
 - 1 spessimetro di precisione, 20 lame (BGS 3083)
 - 1 lucchetto in ottone, 40 mm (BGS 3098)
 - 1 martello tipo tedesco, con manico in fibra di vetro, DIN 1041, 800 g (BGS 3855)
 - 1 set inserti colorati, 32 pezzi (BGS 4816)
 - 1 cutter retraibile, lama 18 mm (BGS 7980)
 - 1 flessometro, 19 mm x 5 m (BGS 8394)
 - 1 metro pieghevole in legno, 2 m (BGS 2053)
 - chiavi poligonali doppie:
 - 6 x 7 mm (BGS 1214-6x7), 8 x 9 mm (BGS 1214-8x9), 10 x 11 mm (BGS 1214-10x11), 12 x 13 mm (BGS 1214-12x13), 14 x 15 mm (BGS 1214-14x15), 16 x 17 mm (BGS 1214-16x17), 18 x 19 mm (BGS 1214-18x19), 20 x 22 mm (BGS 1214-20x22), 21 x 23 mm (BGS 1214-21x23), 24 x 27 mm (BGS 1214-24x27), 25 x 28 mm (BGS 1214-25x28), 30 x 32 mm (BGS 1214-30x32)
 - chiavi combinate:
 - 6 mm (BGS 1056), 7 mm (BGS 1057), 8 mm (BGS 1058), 9 mm (BGS 1059), 10 mm (BGS 1060), 11 mm (BGS 1061), 12 mm (BGS 1062), 13 mm (BGS 1063), 14 mm (BGS 1064), 15 mm (BGS 1065), 16 mm (BGS 1066), 17 mm (BGS 1067), 18 mm (BGS 1068), 19 mm (BGS 1069), 20 mm (BGS 1070), 21 mm (BGS 1071), 22 mm (BGS 1072), 23 mm, 24 mm (BGS 1074), 25 mm (BGS 1075), 26 mm (BGS 1076), 27 mm (BGS 1077), 28 mm, 30 mm (BGS 1080), 32 mm (BGS 1082)
 - 1 cricchetto reversibile, att. 1/2" (BGS 620)
 - 1 barra con quadro scorrevole, att. 1/2" (BGS 289)
 - 1 giunto snodo, att. 1/2" (BGS 251)
 - prolunghe con testa sferica, att. 1/2": 125 mm (BGS 234) - 250 mm (BGS 235)
 - bussole per candele, esagonale, att. 1/2": 16 mm (BGS 2472), 21 mm (BGS 2470)
 - bussole, esagonali, att. 1/2":
 - 8 mm (BGS 2908), 9 mm (BGS 2909), 10 mm (BGS 2910), 11 mm (BGS 2911), 12 mm (BGS 2912), 13 mm (BGS 2913), 14 mm (BGS 2914), 15 mm (BGS 2915), 16 mm (BGS 2916), 17 mm (BGS 2917), 18 mm (BGS 2918), 19 mm (BGS 2919), 20 mm (BGS 2920), 21 mm (BGS 2921), 22 mm (BGS 2922), 23 mm, 24 mm (BGS 2924), 27 mm (BGS 2927), 30 mm (BGS 2930), 32 mm (BGS 2932), 36 mm (BGS 2936)
 - 1 pinza professionale, 165 mm (BGS 369)
 - 1 tronchese taglio diagonale, 165 mm (BGS 393)
 - 1 pinza regolabile, 240 mm (BGS 75111)
 - cacciaviti, ph: PH1 x lama 80 mm (BGS 4935), PH2 x lama 100 mm (BGS 4936), PH3 x lama 150 mm (BGS 4937)
 - cacciaviti, Taglio: 4 x lama 80 mm (BGS 4929), 5,5 x lama 125 mm (BGS 4930), 6,5 mm x lama 150 mm (BGS 4931), 8,0 mm x lama 200 mm
- peso: 24,2 kg



assortimento speciale
per **CAMIONISTI**

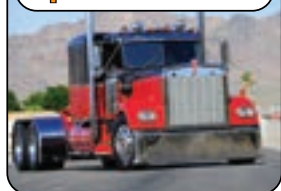

**BUSSOLE
ESAGONALI**



FERMEC
articolo

DESCRIZIONE

64230

CASSETTA 58 PEZZI, BUSSOLE E UTENSILI ASSORTITI PER TRUCK

CARATTERISTICHE

- assortimento particolarmente indicato per operazioni su veicoli pesanti/trucks
- cassetta in ABS ad alta resistenza con 4 chiusure
- dimensioni cassetta: (lunghezza x larghezza x altezza) 535 x 420 x 100 mm
- comprende:
 - 18 chiavi combinate: 7 - 8 - 10 - 11 - 12 - 13 - 14 - 15 - 16 - 17 - 18 - 19 - 21 - 22 - 24 - 27 - 30 - 32 mm
 - 16 chiavi a bussola esagonali att. 1/2": 10 - 11 - 12 - 13 - 14 - 15 - 16 - 17 - 18 - 19 - 21 - 22 - 24 - 27 - 30 - 32 mm
 - 4 chiavi a L esagonali: 4 - 6 - 8 - 10 mm
 - 4 chiavi a L Torx: TX10 - TX20 - TX25 - TX30
 - 2 prolunghe att. 1/2": 125, 250 mm
 - snodo, att. 1/2"
 - testa scorrevole per prolunghe, att. 1/2"
 - 3 cacciaviti taglio: 5,5 x 125 mm - 6,5 x 150 mm - 6 x 38 mm
 - 3 cacciaviti PH: PH1 X 75 mm - PH2 X 100 mm - PH 2 X 38 mm
 - cricchetto reversibile con sgancio rapido, att. 1/2"
 - cacciavite cercafase 250 V
 - martello 300 gr
 - pinza universale 180 mm
 - pinze giratubi regolabili 250 mm
 - forbici 140 mm



**BUSSOLE
ESAGONALI**



1/4"



BGS
articolo

DESCRIZIONE

BGS 2037

**CASSETTA 58 PEZZI,
BUSSOLE E UTENSILI ASSORTITI**

CARATTERISTICHE

- comprende:
 - utensili con attacco quadro 1/4":
 - cricchetto reversibile, 72 denti
 - prolunga, 50 mm
 - adattatore portainseri con attacco 1/4"
 - bussole, finitura satinata cromata: 4 - 6 - 7 - 8 - 9 - 10 - 11 - 12 - 13 mm
 - inserti attacco esagonale 1/4":
 - taglio: 3 - 4 - 5 - 6 mm
 - PH: PH1 - PH2 - PH3
 - PZ: PZ1 - PZ2 - PZ3
 - Torx: T10 - T15 - T20 - T25 - T27 - T30
 - esagonali: 3 - 4 - 5 - 6 mm
 - cacciaviti:
 - taglio:
 - 0,4x2,0x50 mm - 0,4x2,5x50 mm - 0,5x3,0x50 mm
 - 1,0x5,5x75 mm - 1,2x6,5x38 mm - 1,2x6,5x100 mm
 - PH:
 - PH00x50 mm - PH0x50 mm - PH1x75 mm
 - PH2x38 mm - PH2x100 mm
 - impugnatura portainseri con attacco esagonale 1/4", lunghezza 75 mm
 - chiavi a L esagonali: 1,5 - 2 - 2,5 - 3 - 4 - 5 - 6 - 8 - 10 mm
 - pinza regolabile, 245 mm
 - pinze, 180 mm
 - pinze a becchi mezzotondi dritti, 200 mm
 - martello, 300 g
 - peso: 3,3 kg



BGS articolo	DESCRIZIONE
BGS 2217	CASSETTA 67 PEZZI, BUSSOLE E UTENSILI ASSORTITI

CARATTERISTICHE

- comprende:
- cassetta in plastica
- cricchetto reversibile, attacco quadro 1/4", lunghezza 155 mm, tupo curvo, impugnatura in materiale bi-componente
- impugnatura porta inserti, lunghezza 200 mm (BGS 217)
- prolunga, attacco 1/4", lunghezza: 50 mm, finitura satinata cromata (BGS 2336)
- snodo, attacco 1/4", finitura satinata cromata (BGS 250)
- adattatore portainseriti: quadro femmina 1/4" - esagono femmina 1/4", finitura satinata cromata (BGS 8213)
- bussole esagonali, attacco 1/4", finitura satinata cromata: 4 - 4.5 - 5 - 5.5 - 6 - 7 - 8 - 9 - 10 - 11 - 12 - 13 - 14 mm
- bussole esagonali, lunghe, attacco 1/4", finitura satinata cromata: 9 - 10 - 11 - 12 - 13 mm
- inserti attacco esagonale 1/4", lunghezza 25 mm:
 - Taglio: 3 - 4 - 5 - 6 mm
 - PH: PH1 - PH2 - PH3
 - PZ: PZ1 - PZ2 - PZ3
 - Esagonali: 3 - 4 - 5 - 6 mm
 - Torx: TX10 - TX15 - TX20 - TX25 - TX27 - TX30
- pinze professionali, 175 mm, impugnature antiscivolo in materiale bi-componente (BGS 370)
- pinze a becchi mezzotondi dritte, 200 mm, impugnature antiscivolo in materiale bi-componente (BGS 389)
- cacciavite PH1, lunghezza lama 80 mm (BGS 4935)
- cacciavite PH2, lunghezza lama 100 mm (BGS 4936)
- cacciavite Taglio 4 mm, lunghezza lama 80 mm (BGS 4929)
- cacciavite Taglio 5.5 mm, lunghezza lama 125 mm (BGS 4930)
- cacciavite Taglio 6.5 mm, lunghezza lama 150 mm (BGS 4931)
- set 6 pezzi cacciaviti di precisione (BGS 9151)
 - cacciaviti Taglio: 2 - 3 - 4 mm
 - cacciaviti PH: PH 00, PH 0, PH 1
 - punte con rivestimento al fosfato
 - lame al cromo vanadio, satinare cromate
 - impugnature in materiale bi-componente
 - lunghezza lama 75 mm
- pinze regolabili, 240 mm, apertura max 38 mm (Art. BGS 75111)
- set 9 pezzi, chiavi maschio esagonali piegate, tipo corto, 1.5 - 2 - 2.5 - 3 - 4 - 5 - 6 - 8 - 10 mm (BGS 807)
- martello tipo tedesco, impugnatura in hickory, DIN 1041, 300 g (BGS 52303)
- peso: 5,0 kg

**BUSSOLE
ESAGONALI**

PRO+

BGS articolo	DESCRIZIONE
BGS 9029	CASSETTA 117 PEZZI, BUSSOLE E UTENSILI ASSORTITI

CARATTERISTICHE

- utensili attacco 1/4":
 - cricchetto con sgancio rapido, 72 denti, lunghezza 145 mm, impugnatura in materiale bi-componente
 - bussole esagonali: 4-5-6-7-8-9-10-11-12-13 mm
 - bussole esagonali lunghe: 9-10-11-12-13 mm
 - impugnatura attacco quadro 150 mm
 - snodo
 - prolunga 50 mm
 - adattatore portainseriti attacco 1/4" esagonale
- utensili attacco 1/2":
 - cricchetto con sgancio rapido, 72 denti, lunghezza 145 mm, impugnatura in materiale bi-componente
 - bussole esagonali: 10-11-12-13-14-15-17-19-22-24-27-30-32 mm
 - prolunga 125 mm
 - snodo
- set 32 inserti att. 1/4" colorati lunghezza 25 mm
 - Taglio 3-4-5-6 mm
 - PH: 1-2-2-3
 - PZ: 1-2-2-3
 - Esagonali: 3-4-5-6 mm
 - Torx: TX10-15-20-25-27-30-40
 - Torx con Foro: TH10-15-20-25-27-30-40
 - adattatore portabussole
 - portainseriti a sgancio rapido
- chiavi combinate finitura satinata cromata: 6 - 7 - 8 - 9 - 10 - 11 - 12 - 13 - 14 - 17 - 19 - 22 mm
- tronchese taglio diagonale, 165 mm, impugnature in materiale bi-componente
- pinza, 175 mm, impugnature in materiale bi-componente
- pinza regolabile, 240 mm, impugnature rivestite, apertura max 38 mm
- pinza per crimpatura 235 mm
 - per morsetti non isolati di formato: 1,5 - 2,5 - 4,6 mm
 - per morsetti isolati di formato: 1,5 mm (rosso) - 2,5 mm (blu) - 6 mm (giallo)
 - spellafilii: 0,75 - 1,0 - 1,5 - 2,5 - 4,0 - 6,0 mm
 - tagliabulloni per teste bulloni: M2,6 - M3 - M3,5 - M4 - M5
- assortimento terminali isolati
- cacciaviti Taglio: 6x38, 6x100, 8x150 mm
- cacciaviti: PH2x38, PH2x100 mm
- martello tipo tedesco, impugnatura in hickory, 300 g
- torcia a led estensibile con magnete
 - asta telescopica estensibile da 170 a 545 mm con testa magnetica flessibile per sollevare oggetti in metallo
 - 3 led ad alta luminosità e lunga durata
 - corpo in alluminio con clip
 - capacità magnete: 1 kg
 - diametro: 25 mm
 - alimentazione 4 batterie LR44, incluse
- peso: 8,2 kg



**PER
ELETTRICISTI**

1000 V



PRO+

CON 118
UTENSILI

BUSSOLE
SURFACE DRIVE



BSG articolo	DESCRIZIONE
BGS 15503	VALIGETTA CON 118 UTENSILI, IDEALE PER ELETTRICISTI

CARATTERISTICHE

- comprende anche utensili isolati conformi DIN EN/IEC 60900
- in una robusta custodia rigida in plastica ABS con angoli rinforzati, che protegge la custodia da eventuali danni e la rende particolarmente resistente
- tutti gli utensili sono fissati da cinghie elastiche o da chiusure a gancio o ad anello
- pannelli per utensili in fibra di legno MDF rivestiti per resistere allo sporco
- con inserto in schiuma EPE, nell'area inferiore
- con bussole, cricchetti reversibili, pinze VDE, cacciaviti VDE e chiavi combinate in acciaio al cromo vanadio
- finitura cromata satinata
- inserti in acciaio al cromo vanadio (S2) di alta qualità, ogni impronta un colore
- comprende:
 - cricchetti reversibili: att. 1/4" - att. 1/2"
 - 13 bussole, surface drive, att. 1/4": 4-4,5-5-5,5-6-7-8-9-10-11-12-13-14 mm
 - 13 bussole, surface drive, att. 1/2": 10-13-14-16-17-18-19-20-22-24-27-30-32 mm
 - 1 impugnatura con quadro scorrevole 1/4"
 - snodi: att. 1/4" - att. 1/2"
 - 2 prolunghe con testa sferica, att. 1/4": 50 - 100 mm
 - 2 prolunghe con testa sferica, att. 1/2": 125 - 250 mm
 - 1 adattatore scorrevole per prolunghe, att. quadro esterno 1/2"
 - 1 adattatore portainseriti, att. quadro 1/4", esagono femmina 1/4"
 - 1 martello tipo tedesco, manico in hickory, DIN 1041, 300 g
 - 1 flessometro, 19 mm x 5 m
 - serie 9 chiavi a L, extra lunghe, Esagonali, con testa sferica sul lato lungo: 1,5 - 2 - 2,5 - 3 - 4 - 5 - 6 - 8 - 10 mm
 - serie 9 Chiave a L, extra lunghe Torx con foro: TH10 - TH15 - TH20 - TH25 - TH27 - TH30 - TH40 - TH45 - TH50
 - 1 seghetto in alluminio con lama 150 mm
 - 1 chiave a rullino regolabile, con impugnatura in gomma, max. 25 mm
 - 1 scalpello a, 6 x 200 mm
 - 1 raschietto lama in acciaio inox, impugnatura in gomma bi-componente
 - 1 impugnatura portainseriti, attacco esagonale 1/4", 200 mm
 - 8 chiavi combinate: 8 - 10 - 11 - 12 - 13 - 14 - 17 - 19 mm
 - 1 coltello per cavi isolato vde, con protezione antiscivolo, 160 mm
 - 1 pinze a becchi mezzotondi piegati, isolate VDE, 200 mm
 - 1 pinze professionali, isolate VDE, 180 mm
 - 1 pinza regolabili isolate VDE, 250 mm
 - 1 pinza spelafili isolate VDE, 160 mm
 - cacciaviti VDE: PH1x80 mm, PH2x100 mm, Taglio 3x75 mm, Taglio 4x100 mm
 - 1 tester di tensione, 120 - 250 V, 140 mm
 - 1 livella ad acqua in alluminio, 300 mm
 - 1 metro pieghevole in legno, 2 m
 - 1 rilevatore di tensione con display digitale
 - 1 set 32 pezzi inserti colorati
 - 1 cutter retraibile, corpo in zinco pressofuso, lama da 18 mm
 - 1 valigetta vuota in plastica ABS, per BGS 15503
- peso 12,6 kg

RICAMBI

BSG articolo	DESCRIZIONE
BGS 15503-1	VALIGETTA VUOTA



**PER
MECCANICI**

CON 106
UTENSILI

BUSSOLE
ESAGONALI



BSG articolo	DESCRIZIONE
BGS 15505	VALIGETTA CON 106 UTENSILI, IDEALE PER MECCANICI

CARATTERISTICHE

- in una robusta custodia rigida in plastica ABS con angoli rinforzati, che protegge la custodia da eventuali danni e la rende particolarmente resistente
- tutti gli utensili sono fissati da cinghie elastiche o da chiusure a gancio o ad anello
- pannelli per utensili in fibra di legno MDF rivestiti per resistere allo sporco
- con inserto in schiuma EPE, nell'area inferiore
- bussole, barra di prolunga, cricchetto reversibile, pinze e chiavi combinate in acciaio al cromo vanadio
- finitura cromata satinata
- Chiavi a L, cacciaviti e punte in acciaio al cromo vanadio di alta qualità (S2)
- inserti in acciaio al cromo vanadio (S2) di alta qualità, ogni impronta un colore
- comprende:
 - cricchetti reversibili: att. 1/4" (BGS 318) - att. 1/2" (BGS 620)
 - set 6 pezzi, cacciaviti di precisione (BGS 9151)
 - 1 tester di tensione, 120 - 250 V, 140 mm (BGS 725)
 - 1 livello ad acqua in alluminio, 300 mm (BGS 3574)
 - cacciaviti: PH2 x 100 (BGS 4936) - PH1 x 80 mm (BGS 4935) P22 x 100 mm (BGS 4933) - Taglio 5 mm x 75 mm - Taglio 6 mm x 100 mm
 - 1 impugnatura portainseriti, attacco 1/4", lunghezza 200 mm (BGS 217)
 - 1 martello tipo tedesco, manico in fibra di vetro, DIN 1041, 300 g (BGS 3852)
 - set chiavi a L, extra lunghe, Esagonali, con testa sferica sul lato lungo: 1,5 (BGS 790-1,5) - 2 (BGS 790-2) - 2,5 (BGS 790-2,5) - 3 (BGS 790-3) - 4 (BGS 790-4) 5 (BGS 790-5) - 6 (BGS 790-6) - 8 (BGS 790-8) - 10 (BGS 790-10)
 - 1 raschietto, con lama in acciaio inox impugnatura in gomma (BGS 3063)
 - 1 lampada a batteria, COB-LED, 5W, 5 W (BGS 85334)
 - 1 seghetto in alluminio con lama 150 mm (BGS 2083)
 - 1 pinza a crimpare, 235 mm (BGS 418)
 - 1 pinze regolabili, 240 mm (BGS 75111)
 - 1 forbici multiuso in acciaio inox, 180 mm (BGS 7962)
 - 1 pinze professionali, 175 mm (BGS 370)
 - 1 tronchese taglio diagonale ad alta resistenza, 165 mm (BGS 393)
 - 1 pinza a becchi mezzotondi dritti, 200 mm (BGS 389)
 - chiavi combinate: 8 (BGS 30558) - 10 (BGS 30560) - 11 (BGS 30561) 12 (BGS 30562) - 13 (BGS 30563) - 14 (BGS 30564) - 15 (BGS 30565) - 17 (BGS 30567) 19 (BGS 30569) - 22 (BGS 30572)
 - 1 asta telescopica, 650 mm, portata 3 kg (BGS 3188)
 - 1 set 32 pezzi, inserti colorati (BGS 4816)
 - 1 cutter retraibile, lame da 18 mm (BGS 7955)
 - 1 bussola porta inserti con sfera di tenuta, att. 3/8", esag. 1/4" (BGS 8225)
 - 1 flessometro, 19 mm x 5 m (BGS 8394)
 - 1 prolunga con testa sferica, att. 3/8", 75 mm (BGS 242)
 - 1 cricchetto reversibile, att. 3/8" (BGS 619)
 - 1 snodo, att. 3/8" (BGS 299)
 - bussole, esagonali, attacco 3/8": 6 - 7 - 8 - 9 - 10 (BGS 10610) - 10 11 (BGS 10611) - 12 (BGS 10612) - 13 (BGS 10613) - 14 (BGS 10614) - 15 (BGS 10615) 16 (BGS 10616) - 17 (BGS 10617) - 18 (BGS 10618) - 19 (BGS 10619) - 21 - 22 - 24 mm
 - 1 valigetta vuota in plastica ABS (BGS 15505-1)
- peso 9,1 kg

RICAMBI

BSG articolo	DESCRIZIONE
BGS 15505-1	VALIGETTA VUOTA

**PER
IDRAULICI**

**CON 95
UTENSILI**
**BUSSOLE
ESAGONALI**

BGS
 articolo

DESCRIZIONE
BGS 15502
**VALIGETTA CON 95 UTENSILI,
IDEALE PER IDRAULICI**
CARATTERISTICHE

- in una robusta custodia rigida in plastica ABS con angoli rinforzati, che protegge la custodia da eventuali danni e la rende particolarmente resistente
- tutti gli utensili sono fissati da cinghie elastiche o da chiusure a gancio o ad anello
- pannelli per utensili in fibra di legno MDF rivestiti per resistere allo sporco
- con inserto in schiuma EPE, nell'area inferiore
- bussole, barra di prolunga, cricchetto reversibile, pinze e chiavi combinate in acciaio al cromo vanadio, finitura cromata satinata
- chiavi a L, cacciaviti e punte in acciaio al cromo vanadio di alta qualità (S2)
- inserti in acciaio al cromo vanadio (S2) di alta qualità, ogni impronta un colore
- comprende:
 - 1 cricchetto, quadro femmina passante 1/2" (BGS 312)
 - 1 adattatore doppio quadro maschio 1/2", per uso con BGS 312 (BGS 313)
 - bussole, esagonali, att. 1/2": 10 (BGS 2910) - 11 (BGS 2911) - 12 (BGS 2912) - 13 (BGS 2913) - 14 (BGS 2914) - 15 (BGS 2915) - 16 (BGS 2916) - 17 (BGS 2917) - 18 (BGS 2918) - 19 (BGS 2919) - 21 (BGS 2921) - 22 (BGS 2922) - 24 (BGS 2924)
 - 1 prolunga testa sferica, att. 1/2", 125 mm (BGS 234)
 - 1 snodo, 1/2" (BGS 251)
 - 1 chiave per radiatori, att. 1/2", 5 step (BGS 1461)
 - 1 martello tipo tedesco, impugnatura in hickory, DIN 1041, 300 g (BGS 52303)
 - 1 set 32 pezzi inserti colorati (BGS 4816)
 - chiavi fisse a forchetta doppie: 6 x 7 (BGS 30606) - 8 x 9 (BGS 30608) - 10 x 11 (BGS 30610) - 12 x 13 (BGS 30612) - 14 x 15 (BGS 30614) - 16 x 17 (BGS 30616) - 18 x 19 (BGS 30618) - 20 x 22 (BGS 30620) - 21 x 23 (BGS 30621) - 24 x 27 (BGS 30624) - 30 x 32 (BGS 30630)
 - chiavi a "L" tipo extra lungo, con testa sferica: 1,5 (BGS 790-1,5)-2 (BGS 790-2)-2,5 (BGS 790-2,5)-3 (BGS 790-3)-4 (BGS 790-4) - 5 (BGS 790-5)-6 (BGS 790-6)-8 (BGS 790-8)-10 (BGS 790-10)
 - 1 lampada a batteria pieghevole, COB-LED 5 W (BGS 85334)
 - 1 metro pieghevole in legno, 2 m (BGS 2053)
 - 1 livella ad acqua in alluminio, 300 mm (BGS 3574)
 - 1 tester di tensione, 120 - 250 V, 140 mm (BGS 725)
 - 1 impugnatura, att. 1/4, 150 mm (BGS 216)
 - cacciaviti: PH1 x 80 mm (BGS 4935) - PH2 x 100 mm (BGS 4936)
 - cacciaviti Taglio: 4 x 80 (BGS 4929) - 5,5 x 125 (BGS 4930) - 6,5 x 150 (BGS 4931)
 - 1 seghetto in alluminio, con lama 150 mm (BGS 2083)
 - 1 spazzola metallica, in ottone, 260 mm (BGS 3173)
 - 1 pinze regolabili, 240 mm (BGS 75111)
 - 1 raschietto, lama in acciaio inox, impugnatura in gomma con foro (BGS 3063)
 - 1 cutter retraibile, corpo in zinco pressofuso, lama 18 mm (BGS 7958)
 - 1 chiave per lavabo (BGS 8330)
 - 1 lima manuale, taglio 3, 200 mm (BGS 6552)
 - 1 giratubi modello svedese, 1" (BGS 525)
 - 2 scalpelli: 6 x 200 mm (BGS 1699) - scalpello piatto, 25 x 250 mm (BGS 1698)
 - 1 chiave a croce per sanitari (BGS 8448)
 - tagliatubi: Ø 3 - 35 mm (BGS 8341) - Ø 3 - 30 mm (BGS 9521)
 - 1 valigetta vuota per BGS 15502 (BGS 15502-1)
- peso 13,5 kg

RICAMBI
BGS
 articolo

DESCRIZIONE
BGS 15502-1
VALIGETTA VUOTA

66 PEZZI

BGS
 articolo

DESCRIZIONE
BGS 6057
VALIGETTA IN ALLUMINIO CON 66 UTENSILI
CARATTERISTICHE

- comprende:
 - set 3 pezzi,
 - tronchese taglienti laterali, 165 mm
 - pinza, 160 mm
 - pinza becchi mezzotondi lunghi, 165 mm
 - cutter con lama retraibile, 18 mm
 - set 5 pezzi, punte HSS, 4 - 5 - 6 - 8 - 10 mm, in scatola in plastica
 - set 4 pezzi, cacciaviti
 - impugnature ergonomiche a presa morbida
 - Taglio: 5,0 x 75 mm - 6,0 x 100 mm
 - PH: PH1 x 75 mm - PH2 x 100 mm
 - impugnatura portainseri magnetico a cricchetto, att. 1/4", lunghezza 160 mm
 - set 7 pezzi, chiavi combinate, 8 - 10 - 11 - 12 - 13 - 14 - 17 mm
 - serie 9 pezzi, chiavi a "L" esagonali con testa sferica, 1,5 - 2 - 2,5 - 3 - 4 - 5 - 6 - 8 - 10 mm
 - set 31 pezzi, inserti attacco 1/4"
 - in scatola in plastica
 - lunghezza 25 mm
 - Taglio: 3 (x 2) - 4 (x 2) - 5 (x 2) - 6 mm (x 2) - 7 mm (x 1)
 - PH: PH0 (x 1) - PH1 (x 2) - PH 2 (x 1) - PH3 (x 1)
 - PZ: PZ0 (x 1) - PZ1 (x 1) - PZ2 (x 1) - PZ3 (x 1)
 - Torx: TX10 - TX15 - TX20 - TX25 - TX27 - TX30 - TX40
 - portainseri magnetico, 60 mm
 - adattatore portabussole att. 1/4"
 - flessometro 18 mm x 5 m
 - martello tipo tedesco, 300 g
 - livella ad acqua, magnetica, 230 mm
 - chiave a rullino, impugnatura in materiale bi-componente, lunghezza 200 mm, apertura 0 - 25 mm
- dimensioni vani:
 - vano inferiore, interno: 350 x 255 x 65 mm
 - vano coperchio, interno: 350 x 255 x 50 mm
 - pannello, dimensioni: 320 x 240 x 8 mm
- dimensioni esterne (lunghezza x larghezza x altezza): 425 x 350 x 235 mm
- valigetta portautensili in alluminio con pannello pieghevole
- moduli in schiuma EVA bi-componente
- peso: 5,1 kg



BUSSOLE ESAGONALI



129 PEZZI

VALIGETTA IN ALLUMINIO RINFORZATA

BUSSOLE SURFACE DRIVE



149 PEZZI

1/4"
1/2"

CV

PRO+

BGS
articolo

DESCRIZIONE

BGS 2204 VALIGETTA IN ALLUMINIO CON 129 UTENSILI

CARATTERISTICHE

- comprende:
 - cutter con lama 18 mm + 10 lame di ricambio
 - chiave regolabile a rullino, 200 mm
 - pinza regolabile, 250 mm
 - pinza, 175 mm
 - pinza becchi mezzotondi lunghi, 200 mm
 - livella, 230 mm
 - flessometro, 15 mm x 3 m
 - chiave a cricchetto reversibile, att. quadro 1/4", 72 denti
 - prolunga, att. quadro 1/4", 100 mm
 - impugnatura, att. quadro 1/4", 150 mm
 - set 13 bussole su guida, att. quadro 1/4": 4 - 4,5 - 5 - 5,5 - 6 - 7 - 8 - 9 - 10 - 11 - 12 - 13 - 14 mm
 - adattatore portainseriti: quadro 1/4" - esagono 1/4"
 - inserti attacco esagonale 1/4":
 - 19 pezzi, taglio 3 - 8 mm
 - 11 pezzi, esagonale 2 - 8 mm
 - 8 pezzi, PZ0 - PZ3
 - 8 pezzi, PH0 - PH3
 - 10 pezzi, Torx, TX8 - TX40
 - 4 pezzi, quadro 2 - 3,5 mm
 - 1 portainseriti
 - tester a cacciavite, 100 - 250 volt
 - mini cacciavite:
 - taglio: 2,5x50 mm
 - PH: PH00x50 mm
 - cacciaviti a taglio: 5,5x75 mm, 6,5x100 mm, 8x125 mm
 - cacciaviti PH: PH1x75 mm, PH2x100 mm
 - impugnatura portainseriti, att. esagonale 1/4"
 - seghetto 260 mm + 7 lame
 - set 9 chiavi a "L" esagonali con testa sferica: 1,5 - 2 - 2,5 - 3 - 4 - 5 - 6 - 8 - 10 mm
 - chiavi a forchetta doppie, cromate satinata: 6x7 - 8x9 - 10x11 - 12x13 - 14x15 - 16x17 - 18x19 - 20x22 mm
 - martello, 300 g
- valigetta in alluminio dimensioni: 425 x 350 x 135 mm
- peso: 7,7 kg

RICAMBI

BGS
articolo

DESCRIZIONE

BGS 2204-LEER CASSETTA VUOTA IN ALLUMINIO PER BGS 2204

BGS
articolo

DESCRIZIONE

BGS 15501 VALIGETTA PROFESSIONALE IN ALLUMINIO CON 149 UTENSILI

CARATTERISTICHE

- cricchetti reversibili: 1/4" + 1/2"
- bussole att. 1/4", surface drive: 4-4,5-5-5,5-6-7-8-9-10-11-12-13-14 mm
- bussole att. 1/2", surface drive: 10-13-14-16-17-18-19-20-22-24-27-30-32 mm
- impugnatura portabussole, att. Quadro maschio 1/4"
- snodi: 1/4" + 1/2"
- prolunghe att. 1/4": 50 + 100 mm
- prolunghe att. 1/2": 125 + 250 mm
- leva a t con quadro Scorrevole 3/8" F, 1/2" M
- adattatore portainseriti esagonali att. 1/4", att. Quadro 1/4"
- martello tipo tedesco 300 g, manico HICKORY, DIN 1041
- flessometro 5 m, 19 mm
- chiavi a L esagonali, finitura satinata, in supporto pieghevole: 1,5 - 2 - 2,5 - 3 - 4 - 5 - 6 - 8 - 10 mm
- chiavi a L Torx, finitura satinata, in supporto pieghevole: TX10 - TX15 - TX20 - TX25 - TX27 - TX30 - TX40 - TX45 - TX50
- cacciavite:
 - PH 1 x 75 mm; PH 2 x 100 mm
 - taglio: 5,0 x 0,8 x 75 mm; 6,5 x 1,2 x 100 mm
- impugnatura porta inserti att. 1/4" 200 mm
- box inserti colorati att. 1/4"
 - PZ 1 - 2 - 3; PH 1 - 2 - 3
 - Taglio 3 - 4 - 5 - 6 mm
 - Torx: TX10 - TX15 - TX20 - TX25 - TX27 - TX30 - TX40
 - Esagono: 3 - 4 - 5 - 6 mm
 - Adattatore Portainseriti quadro femmina 1/4" - 1/4" esagonale
 - Portainseriti gancio rapido
- cutter con lama retrattile da 18 mm
- tester di tensione con clip, 125 - 250V, 140 mm
- livella a bolla a 3 vie, in alluminio
- tenaglia, 250 mm
- pinza regolabile 250 mm, impugnatura bi-componente
- forbici 180 mm, impugnatura bi-componente
- pinze professionali 180 mm, impugnatura bi-componente
- pinze becchi lunghi 160 mm, impugnatura bi-componente
- tronchese taglio diagonale 160 mm
- pinza per crimpare 235 mm
- assortimento 30 terminali
- chiavi combinate, cromate, estremità lucide: 8 - 10 - 11 - 12 - 13-15 - 17 - 19 mm
- chiave a rullino 8"
- pinza per seeger interni: 165 mm
- pinza per seeger esterni 165 mm
- 260 mm Sega, lame 150 millimetri
- 150 mm lame, 3 pezzi
- **valigetta in alluminio rinforzata**
- peso: 13,6 kg

RICAMBI

BGS
articolo

DESCRIZIONE

BGS 15501-LEER CASSETTA VUOTA PER SET BGS 15501

SET 0 1/2"

TOP

**BUSSOLE
ESAGONALI**
159 PEZZI

articolo

DESCRIZIONE
FM 53159
**VALIGETTA-TROLLEY IN ALLUMINIO
CON 159 UTENSILI**
CARATTERISTICHE

- comprende:
 - lima, 200 mm
 - pinza per crimpare, 220 mm
 - pinza regolabile, 250 mm
 - pinze professionali, 180 mm
 - tronchese taglio diagonale, 180 mm
 - pinze a becchi mezzotondi dritti, 160 mm
 - livella
 - set 5 pezzi, cacciaspine e scalpelli
 - set 9 chiavi a "L" Esagonali con testa sferica: 1,5 - 2 - 2,5 - 3 - 4 - 5 - 6 - 8 - 10 mm
 - set 9 chiavi combinate: 8, 10, 11, 12, 13, 15, 17, 19, 22 mm
 - chiave a rullino con impugnatura morbida, 200 mm
 - cacciaviti taglio: 3.0 x 75 mm - 4.0 x 100 mm - 6.5 x 125 mm - 8.0 x 150 mm
 - cacciaviti PH: PH1 x 80 mm - PH2 x 100 mm
 - mini cacciaviti: Taglio 2.5 x 50 mm - PH0 x 50 mm
 - cutter retraibile con lame da 18 mm + lame di ricambio
 - forbici multiuso
 - asta magnetica di raccolta estensibile
 - seghetto con lama 150 mm + lame di ricambio
 - tester di tensione 100-250 V
 - martello tipo tedesco, 300 grammi
 - flessometro: 3 metri
 - calibro 150 mm
 - set bussole e accessori attacco 1/4": cricchetto reversibile, prolunghe 50 e 100 mm, prolunga flessibile 150 mm, impugnatura, snodo, asta con quadro scorrevole 250 mm, adattatore portainseriti attacco esagonale 1/4", bussole esagonali: 4, 5, 6, 7, 8, 9, 10, 11, 12, 13 mm
 - set bussole e accessori attacco 1/2": cricchetto reversibile, prolunga 125 mm, prolunga con quadro scorrevole 250 mm, snodo, adattatore portainseriti attacco esagonale 5/16", bussole per candele: 16 e 21 mm
 - bussole esagonali: 14, 15, 16, 17, 18, 19, 20, 21, 22, 23, 24, 27, 30, 32 mm
 - set 40 pezzi, inserti attacco esagonale 1/4"
 - set 15 pezzi, inserti attacco esagonale 5/16"
- valigetta-trolley in alluminio dimensioni: 520 x 370 x 180 mm
- peso: 13,3 kg

RICAMBI

articolo

DESCRIZIONE
FM 53159-1
**TROLLEY VUOTO IN ALLUMINIO PER
FM 53159**
TOP

**BUSSOLE
ESAGONALI**
159 PEZZI

articolo

DESCRIZIONE
FM 24159
**VALIGETTA IN ALLUMINIO CON 159 UTENSILI
PROFESSIONALI + BUSSOLE DA 1/4" + 1/2"
IDEALE PER ASSISTENZA E MANUTENZIONE**
CARATTERISTICHE

- comprende:
 - lima, 200 mm
 - pinza per crimpare, 220 mm
 - pinza regolabile, 250 mm
 - pinze professionali, 180 mm
 - tronchese taglio diagonale, 180 mm
 - pinze a becchi mezzotondi dritti, 160 mm
 - livella
 - set 5 pezzi, cacciaspine e scalpelli
 - set 9 chiavi a "L" Esagonali con testa sferica: 1,5 - 2 - 2,5 - 3 - 4 - 5 - 6 - 8 - 10 mm
 - set 9 chiavi combinate: 8, 10, 11, 12, 13, 15, 17, 19, 22 mm
 - chiave a rullino con impugnatura morbida, 200 mm
 - cacciaviti taglio: 3.0 x 75 mm - 4.0 x 100 mm - 6.5 x 125 mm - 8.0 x 150 mm
 - cacciaviti PH: PH1 x 80 mm - PH2 x 100 mm
 - mini cacciaviti: Taglio 2.5 x 50 mm - PH0 x 50 mm
 - cutter retraibile con lame da 18 mm + lame di ricambio
 - forbici multiuso
 - asta magnetica di raccolta estensibile
 - seghetto con lama 150 mm + lame di ricambio
 - tester di tensione 100-250 V
 - martello tipo tedesco, 300 grammi
 - flessometro: 3 metri
 - calibro 150 mm
 - set bussole e accessori attacco 1/4": cricchetto reversibile, prolunghe 50 e 100 mm, prolunga flessibile 150 mm, impugnatura, snodo, asta con quadro scorrevole 250 mm, adattatore portainseriti attacco esagonale 1/4", bussole esagonali: 4, 5, 6, 7, 8, 9, 10, 11, 12, 13 mm
 - set bussole e accessori attacco 1/2": cricchetto reversibile, prolunga 125 mm, prolunga con quadro scorrevole 250 mm, snodo, adattatore portainseriti attacco esagonale 5/16", bussole per candele: 16 e 21 mm
 - bussole esagonali: 14, 15, 16, 17, 18, 19, 20, 21, 22, 23, 24, 27, 30, 32 mm
 - set 40 pezzi, inserti attacco esagonale 1/4"
 - set 15 pezzi, inserti attacco esagonale 5/16"
- valigetta in alluminio dimensioni: 520 x 370 x 180 mm
- peso: 13,3 kg

RICAMBI

articolo

DESCRIZIONE
FM 24159-V
**VALIGETTA VUOTA IN ALLUMINIO PER
FM 24159**



novità



BGS articolo	DESCRIZIONE
BGS 11510	ASSORTIMENTO 85 PEZZI, UTENSILI

CARATTERISTICHE	
<ul style="list-style-type: none"> in custodia rigida in alluminio con angoli rinforzati pannello portautensili in MDF con rivestimento antiscorco inserto in schiuma EPE, di alta qualità, incollato nell'area inferiore, con alloggiamenti per gli utensili bussole, prolunghe, cricchetti reversibili e pinze in acciaio al cromo vanadio finitura: cromata satinata chiavi a "L" e inserti in acciaio al cromo vanadio di alta qualità (S2) inserti colorati: ogni impronta un colore comprende: <ul style="list-style-type: none"> - 1 pinze professionali, 165 mm (BGS 369) - 1 tronchese a taglio diagonale ad alta resistenza, 165 mm (BGS 393) - 1 pinze regolabili, 240 mm (BGS 75111) - 1 set 32 pezzi inserti colorati (BGS 4816) - 1 cricchetto reversibile, attacco 1/2" (BGS 620) - 1 prolunga, testa sferica, attacco 1/2", 125 mm (BGS 234) - bussole surface drive, attacco 1/2": 10 mm (BGS 2410), 11 mm (BGS 2411), 12 mm (BGS 2412), 13 mm (BGS 2413), 14 mm (BGS 2414), 15 mm (BGS 2415), 16 mm (BGS 2416), 17 mm (BGS 2417), 18 mm (BGS 2418), 19 mm (BGS 2419), 21 mm (BGS 2421), 24 mm (BGS 2424) - 1 cricchetto reversibile, attacco 1/4" (BGS 618) - 1 impugnatura porta inserti, lunghezza 200 mm (BGS 217) - prolunghe, testa sferica, attacco 1/4": 100 mm (BGS 2231), 50 mm (BGS 2232) - bussole surface drive, attacco 1/4": 4 mm (BGS 2344), 4,5 mm (BGS 2339), 5 mm (BGS 2345), 5,5 mm (BGS 2343), 6 mm (BGS 2346), 7 mm (BGS 2347), 8 mm (BGS 2348), 9 mm (BGS 2349), 10 mm (BGS 2350), 11 mm (BGS 2351), 12 mm (BGS 2352), 13 mm (BGS 2353), 14 mm (BGS 2354) - 1 adattatore portainserti con sfera di fissaggio, attacco quadro 1/4", attacco esagonale 1/4" (BGS 8213) - 1 set 9 pezzi, di chiavi a L, extra lunghe, Torx TX10 - TX50 (BGS 793) - 1 set 9 pezzi di chiavi a L, extra lunghe, Esagonali, 1,5 - 10 mm (BGS 808) peso: 5,9 kg 	



novità



BGS articolo	DESCRIZIONE
BGS 3357	SET 77 PEZZI, UTENSILI ATT. 1/4" E 1/2", BGS SYSTAINER®

CARATTERISTICHE	
<ul style="list-style-type: none"> ampia gamma di utensili adatto a molte applicazioni. sistema intelligente di trasporto e stoccaggio in plastica valigetta in ABS maniglia funzionale e chiusura T-Loc questa valigia fa parte di un sistema multicomponente, impilabile (i contenitori possono essere agganciati ad altri e trasportati) imbottitura protettiva nella palpebra superiore dimensioni interne: larghezza 383 mm, altezza 127,5 mm, profondità 267 mm bussole, barre di prolunga, cricchetti reversibili, pinze in acciaio al cromo vanadio finitura: cromata satinata cacciaviti e bussole in acciaio al cromo vanadio (S2) comprende: <ul style="list-style-type: none"> - 1 cricchetto reversibile, att. 1/4" (BGS 618) - 1 cricchetto reversibile, att. 1/2" (BGS 620) - 1 impugnatura, att. 1/4", 150 mm (BGS 216) - 1 leva con quadro scorrevole, att. 1/4" (BGS 276) - 2 prolunghe, att. 1/4": 50 mm (BGS 2336), 100 mm (BGS 2335) - 2 prolunghe, att. 1/2": 125 mm (BGS 3120), 250 mm (BGS 3121) - 1 snodo, att. 1/4" (BGS 250) - 1 snodo, att. 1/2" (BGS 251) - 2 bussole per candele, esagonali, att. 1/2": 16 mm (BGS 2472), 21 mm (BGS 2470) - 13 bussole, esagonali, att. 1/4": 4 mm (BGS 2474), 4,5 mm (BGS 2475), 5 mm (BGS 2476), 5,5 mm (BGS 2477), 6 mm (BGS 2478), 7 mm (BGS 2479), 8 mm (BGS 2480), 9 mm (BGS 2481), 10 mm (BGS 2482), 11 mm (BGS 2483), 12 mm (BGS 2484), 13 mm (BGS 2485), 14 mm (BGS 2486) - 17 bussole, esagonali, att. 1/2": 10 mm (BGS 2910), 11 mm (BGS 2911), 12 mm (BGS 2912), 13 mm (BGS 2913), 14 mm (BGS 2914), 15 mm (BGS 2915), 16 mm (BGS 2916), 17 mm (BGS 2917), 18 mm (BGS 2918), 19 mm (BGS 2919), 20 mm (BGS 2920), 21 mm (BGS 2921), 22 mm (BGS 2922), 24 mm (BGS 2924), 27 mm (BGS 2927), 30 mm (BGS 2930), 32 mm (BGS 2932) - 6 bussole, att. 1/4" con maschio Torx: TX10 (BGS 2590), TX15 (BGS 2591), TX20 (BGS 2592), TX25 (BGS 2593), TX30 (BGS 2595), TX40 (BGS 2596) - 4 bussole, att. 1/4", con maschio Taglio: 4 mm (BGS 2493), 5,5 mm (BGS 2494), 6,5 mm (BGS 2495), 7 mm (BGS 2496) - 3 bussole, att. 1/4", con maschio PH: PH1 (BGS 2487), PH2 (BGS 2488), PH3 (BGS 2489) - 3 bussole, att. 1/4", con maschio PZ: PZ1 (BGS 2490), PZ2 (BGS 2491), PZ3 (BGS 2492) - 6 bussola, att. 1/4", con maschio Esagonale: 3 mm (BGS 2497), 4 mm (BGS 2498), 5 mm (BGS 2499), 6 mm (BGS 2500), 7 mm (BGS 2501), 8 mm (BGS 2502) - 3 cacciaviti Taglio, 4 mm x lunghezza lama 80 mm (BGS 4929), 5,5 mm x lunghezza lama 125 mm (BGS 4930), 6,5 mm x lunghezza lama 150 mm (BGS 4931) - 2 cacciaviti PH: PH1 x lunghezza lama 80 mm (BGS 4935), PH2 x lunghezza lama 100 mm (BGS 4936) - 1 tester di tensione, 120 - 250 V, 140 mm (BGS 725) - 1 pinza professionale, 175 mm (BGS 370) - 1 pinza regolabile, 240 mm (BGS 75111) - 1 tronchese taglio diagonale ad alta resistenza (BGS 393) - 1 martello tipo tedesco, impugnatura in hickory, DIN 1041, 300 g (BGS 52303) - 1 flessometro 19 mm x 5 m (BGS 8394) - 1 torcia frontale a led cob (BGS 85314) - 2 moduli in schiuma per BGS BOXSYS1 peso: 7,8 kg 	

SET 1/2"

MILLIMETRI
E POLLICI

novità



PRO+

CV

articolo

DESCRIZIONE

BG5 74000

SET 300 PEZZI, BUSSOLE ESAGONALI 1/4" / 3/8" / 1/2", MISURE METRICHE ED IN POLLICI

CARATTERISTICHE

- in una robusta e resistente valigetta in plastica con angoli arrotondati
- con 4 cassetti in plastica + modulo sottocoperchio
- cassetti fissati con 2 blocchi pieghevoli per impedire l'uscita dalle guide
- coperchio superiore con due chiusure a cerniera e maniglia pieghevole in plastica
- bussole, prolunghe, cricchetti reversibili, impugnature e chiavi combinate in acciaio al cromo vanadio
- chiavi a L e inserti in acciaio al cromo vanadio di alta qualità (S2)
- finitura: cromata satinata
- comprende i seguenti utensili attacco 1/4":
 - 11 bussole, Esagonali, in pollici: 5/32", 3/16", 7/32", 1/4", 9/32", 5/16", 11/32", 3/8", 7/16", 1/2", 9/16"
 - 12 bussole, Esagonali, metriche: 4 mm, 5 mm, 5,5 mm, 6 mm, 7 mm, 8 mm, 9 mm, 10 mm, 11 mm, 12 mm, 13 mm, 14 mm
 - 10 bussole, Esagonali lunghe, in pollici: 3/16", 7/32", 1/4", 9/32", 5/16", 11/32", 3/8", 7/16", 1/2", 9/16"
 - 11 bussole, Esagonali lunghe, metriche: 4 mm, 5 mm, 6 mm, 7 mm, 8 mm, 9 mm, 10 mm, 11 mm, 12 mm, 13 mm, 14 mm
 - 1 cricchetto reversibile + 1 adattatore portainseriti att. 1/4" + 1 snodo
 - 1 impugnatura portainseriti, att. esagonale 1/4", 200 mm
 - 3 prolunghe Testa Sferica: 50 mm, 100 mm, 150 mm
 - 5 bussole, Torx: E4, E5, E6, E7, E8
 - 4 chiavi a bussola con maschio Taglio: 4 mm, 5,5 mm, 6,5 mm, 7 mm
 - 6 chiavi a bussola con maschio: PH0, PH1, PH2, PZ0, PZ1, PZ2
 - 4 chiavi a bussola con maschio Esagonali: 3 mm, 4 mm, 5 mm, 6 mm
 - 8 chiavi a bussola con maschio Torx: TX8, TX9, TX10, TX15, TX20, TX25, TX27, TX30
 - 8 chiavi a bussola con maschio Torx c/ Foro: TH8, TH9, TH10, TH15, TH20, TH25, TH27, TH30
- comprende i seguenti utensili attacco 3/8":
 - 11 bussole, Esagonali, in pollici: 1/4", 5/16", 3/8", 7/16", 1/2", 9/16", 5/8", 11/16", 3/4", 13/16", 7/8"
 - 17 bussole, Esagonali, metriche: 6 mm, 7 mm, 8 mm, 9 mm, 10 mm, 11 mm, 12 mm, 13 mm, 14 mm, 15 mm, 16 mm, 17 mm, 18 mm, 19 mm, 20 mm, 21 mm, 22 mm
 - 7 bussole, Esagonali, lunghe in pollici: 3/8", 7/16", 1/2", 9/16", 5/8", 11/16", 3/4"
 - 11 bussole, Esagonali, lunghe metriche: 8 mm, 10 mm, 11 mm, 12 mm, 13 mm, 14 mm, 15 mm, 16 mm, 17 mm, 18 mm, 19 mm
 - 1 cricchetto reversibile + 1 adattatore portainseriti att. 5/16" + 1 snodo
 - 2 prolunghe Testa Sferica: 75 mm, 150 mm
 - 6 bussole, Torx: E10, E11, E12, E14, E16, E18
- comprende i seguenti utensili attacco 1/2":
 - 14 bussole, Esagonali, in pollici: 7/16", 1/2", 9/16", 5/8", 11/16", 3/4", 13/16", 7/8", 15/16", 1", 1.1/16", 1.1/8", 1.3/16", 1.1/4"
 - 14 bussole, Esagonali, metriche: 15 mm, 16 mm, 17 mm, 18 mm, 19 mm, 20 mm, 21 mm, 22 mm, 24 mm, 26 mm, 27 mm, 28 mm, 30 mm, 32 mm
 - 2 bussole, Esagonali, per candele: 16 mm, 21 mm
 - 1 cricchetto reversibile + 1 adattatore portainseriti att. 5/16" + 1 snodo
 - 1 prolunga 75 mm
 - 1 prolunga testa sferica 125 mm
 - 2 bussole, Torx: E20, E24
- comprende i seguenti inserti attacco esagonale 1/4":
 - 2 inserti PH: PH1, PH2
 - 2 inserti PZ: PZ1, PZ2
 - 10 inserti Torx: TX5, TX6, TX7, TX10, TX15, TX20, TX25, TX27, TX30, TX40
 - 8 inserti Torx c/ Foro: TH7, TH10, TH15, TH20, TH25, TH27, TH30, TH40
 - 8 inserti 5 Punti c/ Foro: TS10, TS15, TS20, TS25, TS27, TS30, TS40, TS45
 - 5 inserti RIBE: M5, M6, M7, M8, M9
 - 3 inserti XZN: M5, M6, M8
 - 2 inserti Esagonali: 2 mm, 2,5 mm
 - 7 inserti a bussola esagonale, in pollici: 3/16", 1/4", 5/16", 11/32", 3/8", 7/16", 1/2"
 - 7 inserti a bussola, esagonale, metriche: 5 mm, 6 mm, 7 mm, 8 mm, 9 mm, 10 mm, 11 mm
- comprende i seguenti inserti attacco esagonale 5/16":
 - 3 inserti Taglio: 8 mm, 10 mm, 12 mm
 - 2 inserti PH: PH3, PH4
 - 2 inserti PZ: PZ3, PZ4
 - 5 inserti Esagonali: 7 mm, 8 mm, 10 mm, 12 mm, 14 mm
 - 6 inserti Torx c/ Foro: TH40, TH45, TH50, TH55, TH60, TH70
 - 6 inserti Torx: TX40, TX45, TX50, TX55, TX60, TX70
- 10 chiavi combinate, in pollici: 1/4", 5/16", 11/32", 3/8", 7/16", 1/2", 9/16", 5/8", 11/16", 3/4"
- 14 chiavi combinate, metriche: 6 mm, 7 mm, 8 mm, 9 mm, 10 mm, 11 mm, 12 mm, 13 mm, 14 mm, 15 mm, 16 mm, 17 mm, 18 mm, 19 mm
- 9 chiavi a L, extra lunghe, Esagonali, con testa sferica: 1,5 mm, 2 mm, 2,5 mm, 3 mm, 4 mm, 5 mm, 6 mm, 8 mm, 10 mm
- 1 Set di chiavi a L, misure in pollici, Esagonali, con testa a sfera: 1/16" - 3/8"
- peso: 21,3 kg

TOP

SURFACE DRIVE

108 PEZZI

BUSSOLE SURFACE DRIVE



1/4"
1/2"



FERMEC
articolo

DESCRIZIONE

24108

**CASSETTA 108 PEZZI,
CHIAVI A BUSSOLA SURFACE DRIVE DA 1/4"
& 1/2"
+ BUSSOLE TORX - CHROM-VANADIUM
QUALITÀ EXTRA**

CARATTERISTICHE

- 13 Bussole da 1/4" surface drive: 4, 4.5, 5, 5.5, 6, 7, 8, 9, 10, 11, 12, 13, 14 mm
- 8 Bussole da 1/4" surface drive Lunghe: 6, 7, 8, 9, 10, 11, 12, 13 mm
- 5 Bussole da 1/4" Torx - E4, E5, E6, E8
- 2 Prolunghe da 1/4" - 75, 100 mm
- 1 Impugnatura porta bussole da 1/4"
- 1 Snodo 1/4"
- 1 Leva con quadro scorrevole da 1/4"
- 1 Cricchetto sgancio rapido da 1/4"
- 18 Bussole cromate da 1/4" con inserti:
 - 7 torx: TX8, TX 10, TX 15, TX20, TX25, TX27, TX30
 - 4 esagono - 3, 4, 5, 6 mm
 - 3 taglio - 4, 5.5, 6.5 mm
 - 2 Ph - 1, 2
 - 2 Pz - 1, 2
- 17 Bussole da 1/2" surface drive
10, 11, 12, 13, 14, 15, 16, 17, 18, 19, 20, 21, 22, 24, 27, 30, 32 mm
- 5 Bussole da 1/2" lunghe surface drive: 14, 15, 17, 19, 22 mm
- 8 Bussole da 1/2" Torx: E10, E11, E12, E14, E16, E18, E20, E24
- 1 Cricchetto sgancio rapido da 1/2"
- 2 Prolunghe da 1/2" - 125, 250 mm
- 2 Bussole per candele 1/2": 16, 21 mm
- 1 Snodo da 1/2"
- 1 Quadro scorrevole 1/2"
- 1 Adattatore - Quadro 1/2" - Porta inserti 5/16"
- 17 Inserti 5/16":
 - 5 esagono - 7, 8, 10, 12, 14 mm
 - 3 taglio - 8, 10, 12 mm
 - 2 Ph - 3, 4
 - 2 Pz - 3, 4
 - 5 Torx - T40, T45, T50, T55, T60
- 4 Chiavi maschio esagonali piegate: 1.27, 1.5, 2, 2.5 mm

RICAMBI

FERMEC

DESCRIZIONE

articolo
24108-V

CASSETTA VUOTA PER 24108/35108

SURFACE DRIVE

108 PEZZI

BUSSOLE SURFACE DRIVE



1/4"
1/2"



BGS
articolo

DESCRIZIONE

BGS 2287

**CASSETTA 108 PEZZI,
CHIAVI A BUSSOLA SURFACE DRIVE DA 1/4" & 1/2"
+ BUSSOLE TORX - CHROM-VANADIUM
QUALITÀ EXTRA**

CARATTERISTICHE

- comprende i seguenti utensili attacco 1/4":
 - 13 Bussole da 1/4" surface drive: 4, 4.5, 5, 5.5, 6, 7, 8, 9, 10, 11, 12, 13, 14 mm
 - 8 Bussole da 1/4" surface drive Lunghe: 6, 7, 8, 9, 10, 11, 12, 13 mm
 - 5 Bussole da 1/4" Torx - E4, E5, E6, E7, E8
 - 2 Prolunghe da 1/4" - 50, 100 mm
 - 1 Impugnatura porta bussole da 1/4"
 - 1 Snodo 1/4"
 - 1 Leva con quadro scorrevole da 1/4"
 - 1 Cricchetto sgancio rapido da 1/4"
 - 18 Bussole cromate da 1/4" con inserti:
 - 7 torx: TX8, TX 10, TX 15, TX20, TX25, TX27, TX30
 - 4 esagono - 3, 4, 5, 6 mm
 - 3 taglio - 4, 5.5, 6.5 mm
 - 2 Ph - 1, 2
 - 2 Pz - 1, 2
- comprende i seguenti utensili attacco 1/2":
 - 17 Bussole da 1/2" surface drive
10, 11, 12, 13, 14, 15, 16, 17, 18, 19, 20, 21, 22, 24, 27, 30, 32 mm
 - 5 Bussole da 1/2" lunghe surface drive: 14, 15, 17, 19, 22 mm
 - 8 Bussole da 1/2" Torx: E10, E11, E12, E14, E16, E18, E20, E24
 - 1 Cricchetto sgancio rapido da 1/2"
 - 2 Prolunghe da 1/2" - 125, 250 mm
 - 2 Bussole per candele 1/2": 16, 21 mm
 - 1 Snodo da 1/2"
 - 1 Quadro scorrevole 1/2"
 - 1 Adattatore - Quadro 1/2" - Porta inserti 5/16"
- 17 Inserti 5/16":
 - 5 esagono - 7, 8, 10, 12, 14 mm
 - 3 taglio - 8, 10, 12 mm
 - 2 Ph - 3, 4
 - 2 Pz - 3, 4
 - 5 Torx - T40, T45, T50, T55, T60
- 4 Chiavi maschio esagonali piegate: 1.27, 1.5, 2, 2.5 mm
- peso: 6,5 kg

SET 1/2"

 novità **TOP**
ESAGONALI
**BUSSOLE
ESAGONALI**



 1/4"
1/2"

CROMATE LUCIDE

articolo

FM 35108
DESCRIZIONE
**CASSETTA 108 PEZZI,
CHIAVI A BUSSOLA ESAGONALI DA 1/4" &
1/2"
+ BUSSOLE TORX - CHROM-VANADIUM
QUALITÀ EXTRA**
CARATTERISTICHE

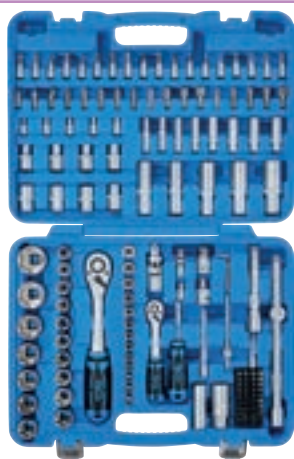
- 13 Bussole da 1/4" esagonali: 4, 4.5, 5, 5.5, 6, 7, 8, 9, 10, 11, 12, 13, 14 mm
- 8 Bussole da 1/4" esagonali Lunghe: 6, 7, 8, 9, 10, 11, 12, 13 mm
- 5 Bussole da 1/4" Torx - E4, E5, E6, E8
- 2 Prolunghe da 1/4" - 75, 100 mm
- 1 Impugnatura porta bussole da 1/4"
- 1 Snodo 1/4"
- 1 Leva con quadro scorrevole da 1/4"
- 1 Cricchetto sgancio rapido da 1/4"
- 18 Bussole cromate da 1/4" con inserti:
 - 4 esagono - 3, 4, 5, 6 mm
 - 3 taglio - 4, 5.5, 6.5 mm
 - 2 Ph - 1, 2
 - 2 Pz - 1, 2
- 7 Torx: T8, T10, T15, T20, T25, T27, T30
- 17 Bussole da 1/2" esagonali
10, 11, 12, 13, 14, 15, 16, 17, 18, 19, 20, 21, 22, 24, 27, 30, 32 mm
- 5 Bussole da 1/2" lunghe esagonali: 14, 15, 17, 19, 22 mm
- 8 Bussole da 1/2" Torx: E10, E11, E12, E14, E16, E18, E20, E24
- 1 Cricchetto sgancio rapido da 1/2"
- 2 Prolunghe da 1/2" - 125, 250 mm
- 2 Bussole per candele 1/2": 16, 21 mm
- 1 Snodo da 1/2"
- 1 Quadro scorrevole 1/2"
- 1 Adattatore - Quadro 1/2" - Porta inserti 5/16"
- 17 Inserti 5/16":
 - 5 esagono - 7, 8, 10, 12, 14 mm
 - 3 taglio - 8, 10, 12 mm
 - 2 Ph - 3, 4
 - 2 Pz - 3, 4
 - 5 Torx - T40, T45, T50, T55, T60
- 4 Chiavi maschio esagonali piegate: 1.27, 1.5, 2, 2.5 mm



 PRO+ 1/4" 1/2"
**BUSSOLE
SURFACE DRIVE**
**CV
S2**

BCS
 articolo

DESCRIZIONE
BCS 74518 SET 150 PEZZI, BUSSOLE ATTACCO 1/4" & 1/2"
CARATTERISTICHE

- con bussole Surface Drive in versione corta e lunga e bussole tipo Torx
- cricchetti reversibili con 90 denti, impugnatura ergonomica in materiale bi-componente e pulsante di sgancio rapido
- bussole zigrinate
- bussole, barre di prolunga, cricchetti reversibili, snodi, adattatori e impugnatura in acciaio al cromo vanadio
- finitura superficiale: cromata satinata
- bussole e inserti in acciaio al cromo vanadio di alta qualità (S2)
- comprende:
 - bussole, Surface Drive, att. 1/4":
4 - 4.5 - 5 - 5.5 - 6 - 7 - 8 - 9 - 10 - 11 - 12 - 13 - 14 mm
 - bussole, Surface Drive, lunghe, att. 1/4": 6 - 7 - 8 - 9 - 10 - 11 - 12 - 13 mm
 - bussole, Torx, att. 1/4": E4 - E5 - E6 - E7 - E8
 - bussole, Surface Drive, att. 1/2":
10 - 11 - 12 - 13 - 14 - 15 - 16 - 17 - 18 - 19 - 20 - 21 - 22 - 24 - 27 - 30 - 32 mm
 - bussole, Surface Drive, lunghe, att. 1/2": 14 - 15 - 17 - 19 - 20 mm
 - bussole, Torx, att. 1/2": E10 - E11 - E12 - E14 - E16 - E18 - E20 - E22
 - bussole maschio, att. 1/4"
- PH: PH1 - PH2
- PZ: PZ1 - PZ2
- Esagonali: 3 - 4 - 5 - 6 mm
- Taglio: 4 - 5.5 - 7 mm
- Torx: TX8 - TX10 - TX15 - TX20 - TX25 - TX27 - TX30
 - inserti att. esagonale 5/16":
- Taglio: 8 - 10 - 12 mm
- PH: PH3 - PH4
- PZ: PZ3 - PZ4
- Esagonali: 7 - 8 - 10 - 12 - 14 mm
- Torx: TX40, TX45, TX50, TX55, TX60
 - inserti att. esagonale 1/4":
- Esagonali: 2 - 2.5 mm
- Torx: TX5 - TX6 - TX7 - TX10 - TX15 - TX20 - TX25 - TX27 - TX30 - TX40
 - Torx c/foro: TH7 - TH10 - TH15 - TH20 - TH25 - TH27 - TH30 - TH40
 - RIBE: M5 - M6 - M7 - M8 - M9
 - XZN: M5 - M6 - M8
- PZ: PZ1 - PZ2
- PH: PH1 - PH2
- Torx plus: TS10 - TS15 - TS20 - TS25 - TS27 - TS30 - TS40 - TS45
- cricchetti reversibili: 1/4", 1/2"
- snodi: 1/4", 1/2"
- prolunghe "testa sferica", att. 1/4": 50 e 100 mm
- prolunghe "testa sferica", att. 1/2": 125 mm e 250 mm
- leva con quadro scorrevole, att. 1/4"
- adattatore scorrevole per prolunghe, att. 1/2"
- bussole per candele, esagonali, att. 1/2": 16 mm, 21 mm
- impugnatura, att. 1/4", lunghezza 150 mm
- adatt. portainseri, att. quadro femmina 1/4", att. esagonale femmina 1/4"
- adatt. portainseri, att. quadro femmina 1/2", att. esagonale femmina 5/16"
- adatt. portainseri, att. quadro femmina 1/2", att. esagonale femmina 1/4"
- chiavi a L, Esagonali: 1.5 - 2 - 2.5 mm

- peso: 7,7 kg

TOP

ESAGONALI



216 PEZZI

 1/4" - 3/8" - 1/2"

CV

BUSSOLE ESAGONALI



CROMATE LUCIDE

FERMEC
articolo

DESCRIZIONE

FM 42840

**CASSETTA 216 PEZZI,
CHIAVI A BUSSOLA CROMATE LUCIDE,
ESAGONALI DA 1/4" - 3/8" - 1/2"
+ CHIAVI COMBinate 8-19 MM**

CARATTERISTICHE

- comprende i seguenti utensili con attacco 1/2":
 - cricchetto reversibile, 2 x prolunghe: 125,250 mm
 - quadro scorrevole per prolunghe con riduzione da 3/8" a 1/2"
 - snodo, 2 x bussole per candele: 16, 21 mm
 - 14 x bussole Esagonali : 13-14-15-16-17-18-19-20-21-22-24-27-30-32 mm
 - 5 x bussole Esagonali lunghe: 16-17-19-21-22 mm
 - 3 x bussole Torx femmina: E20 - E22 - E24
 - bussola Torx maschio Tx-70
 - bussola Esagono maschio 14 mm
- comprende i seguenti utensili con attacco 3/8":
 - cricchetto reversibile, prolunga 125 mm, snodo
 - bussola per candele 18 mm
 - 10 x bussole Esagonali: 10-11-12-13-14-15-16-17-18-19 mm
 - 6 x bussole Esagonali lunghe: 10-11-12-13-14-15 mm
 - 7 x bussole Torx femmina: E10- E12- E14- E16- E18
- comprende i seguenti utensili con attacco 1/4":
 - cricchetto reversibile, prolunghe: 50, 100 mm, snodo
 - chiave a T con quadro scorrevole, impugnatura portabussole
 - 13 x bussole Esagonali: 4-4,5-5-5,5-6-7-8-9-10-11-12-13-14 mm
 - 7 x bussole Esagonali lunghe: 4-5-6-7-8-9-10
 - 5 x bussole Torx femmina: E4 - E5 - E6 - E7 - E8
 - 30 x bussole maschio: Torx, Torx con foro, PH, PZ, Esagono, Taglio
 - adattatore portabussole, adattatori portainseriti
- 30 x inserti att. 5/16"
- 45 x inserti att. 1/4"
- 12 x chiavi combinate: 8 - 19 mm
- 7 x chiavi a L esagonali: 1.27 - 5 mm
- impugnatura portainseriti
- utensili con finitura cromata lucida
- cassetta con ganci in metallo
- misure esterne: 495 X 360 X 105 mm
- peso: 11 kg

TOP

ESAGONALI



216 PEZZI

 1/4" - 3/8" - 1/2"

CV

BUSSOLE ESAGONALI



BGS
articolo

DESCRIZIONE

BGS 15216

**CASSETTA 216 PEZZI,
CHIAVI A BUSSOLA ESAGONALI DA 1/4" - 3/8" -
1/2"
+ CHIAVI COMBinate 8-19 MM**

CARATTERISTICHE

- comprende i seguenti utensili con attacco 1/2":
 - cricchetto reversibile
 - 2 x prolunghe: 125,250 mm
 - quadro scorrevole per prolunghe
 - snodo
 - 2 x bussole per candele: 16, 21 mm
 - riduzione da 3/8" a 1/2"
 - 14 x bussole Esagonali : 13-14-15-16-17-18-19-20-21-22-24-27-30-32 mm
 - 5 x bussole Esagonali lunghe: 16-17-19-21-22 mm
 - 3 x bussole Torx femmina: E20 - E22 - E24
 - bussola Torx maschio Tx-70
 - bussola Esagono maschio 14 mm
- comprende i seguenti utensili con attacco 3/8":
 - cricchetto reversibile
 - prolunga 125 mm
 - snodo
 - bussola per candele 18 mm
 - quadro scorrevole per prolunghe
 - 10 x bussole Esagonali: 10-11-12-13-14-15-16-17-18-19 mm
 - 6 x bussole Esagonali lunghe: 10-11-12-13-14-15 mm
 - 7 x bussole Torx femmina: E10- E12- E14- E16- E18
- comprende i seguenti utensili con attacco 1/4":
 - cricchetto reversibile
 - prolunghe: 50, 100 mm
 - snodo
 - chiave a T con quadro scorrevole
 - impugnatura portabussole
 - 13 x bussole Esagonali: 4-4,5-5-5,5-6-7-8-9-10-11-12-13-14 mm
 - 7 x bussole Esagonali lunghe: 4-5-6-7-8-9-10
 - 5 x bussole Torx femmina: E4 - E5 - E6 - E7 - E8
 - 30 x bussole maschio: Torx, Torx con foro, PH, PZ, Esagono, Taglio
 - 30 x inserti att. 10 mm
 - 44 x inserti att. 1/4"
 - adattatore portabussole
 - adattatori portainseriti
- 12x chiavi combinate: 8 - 19 mm
- 7x chiavi a L esagonali: 1.2 - 5 mm
- impugnatura portainseriti
- peso: 11,0 kg

RICAMBI

BGS
articolo

DESCRIZIONE

BGS 15216-1

CASSETTA VUOTA

SET 0 1/2"



176 PEZZI

**BUSSOLE
SURFACE
DRIVE**

 1/4"
 3/8"
 1/2"

CV

BGS
 articolo

DESCRIZIONE

BGS 15217

**CASSETTA 176 PEZZI, CHIAVI A BUSSOLA
SURFACE DRIVE DA 1/4" - 3/8" - 1/2"
+ CHIAVI COMBinate A CRICCHETTO 8-19 MM**

CARATTERISTICHE

- comprende i seguenti utensili attacco 1/4":
 - cricchetto reversibile 72 denti
 - 13 bussole: 4-4,5-5-5,5-6-7-8-9-10-11-12-13-14 mm
 - 7 bussole lunghe: 4-5-6-7-8-9-10 mm
 - 5 bussole Torx femmina: E4-E5-E6-E7-E8
 - prolunghe: 50, 100 mm
 - snodo
 - impugnatura 150 mm
 - leva con quadro scorrevole
 - 33 bussole con maschio:
 - Taglio: 4,0-5,5-6,5-7,0 mm
 - Croce: PH: 0-1-2, PZ: 0-1-2
 - Esagono: 3-4-5-6 mm
 - Torx: TX8-TX9-TX10-TX15-TX20-TX25-TX27-TX30
 - Torx c/foro: TH8-TH9-TH10-TH15-TH20-TH25-TH27-TH30
 - XZN: M8-M10-M12
- comprende i seguenti utensili attacco 3/8":
 - cricchetto reversibile 72 denti
 - 10 bussole: 10-11-12-13-14-15-16-17-18-19 mm
 - 6 bussole lunghe: 10-11-12-13-14-15 mm
 - 5 bussole Torx femmina: E10-E11-E12-E14-E16
 - prolunga: 125 mm
 - snodo
 - adattatore portainseri per inserti 5/16" (8 mm)
- comprende i seguenti utensili attacco 1/2":
 - cricchetto reversibile 72 denti
 - 17 bussole: 10-11-12-13-14-15-16-17-18-19-20-21-22-24-27-30-32 mm
 - 2 bussole lunghe: 16-18 mm
 - 3 bussole Torx femmina: E18-E20-E24
 - prolunga: 125 mm
 - prolunga: 250 mm con quadro scorrevole per uso come leva a T
 - snodo
 - bussole per candele 16-18-21 mm
 - adattatore portainseri per inserti 5/16" (8 mm)
 - bussole ricoperte per cerchi in lega: 17 - 19-21 mm
- inserti attacco 5/16":
 - 3 Inserti Taglio: 8 - 10-12 mm
 - 6 inserti Torx: TX40-TX45-TX50-TX55-TX60-TX70
 - 6 inserti Torx c/foro: TH40-TH45-TH50-TH55-TH60-TH70
 - Croce: PH: 3-4, PZ: 3-4
 - Esagonali: 7-8-10-12-14 mm
- chiavi a L:
 - 9 Torx c/ foro: TH10-TH15-TH20-TH25-TH27-TH30-TH40-TH45-TH50
 - 9 Esagonali: 1,5-2-2,5-3-4-5-6-8-10 mm
- 12 chiavi combinate a cricchetto: 8-9-10-11-12-13-14-15-16-17-18-19 mm
- peso: 11,6 kg

RICAMBI

BGS
 articolo

DESCRIZIONE

BGS 15217-1

CASSETTA VUOTA

SURFACE
DRIVE
**BUSSOLE
SURFACE
DRIVE**

 1/4"
 3/8"
 1/2"

218 PEZZI

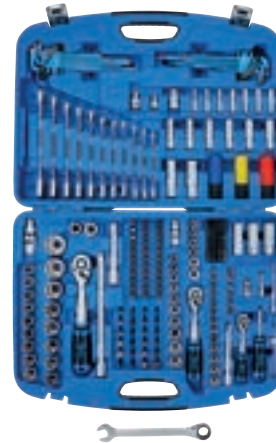

CV

PRO+

BGS
 articolo

DESCRIZIONE

BGS 8820

**CASSETTA 218 PEZZI, CHIAVI A BUSSOLA
SURFACE DRIVE DA 1/4" - 3/8" - 1/2"
+ CHIAVI COMBinate A CRICCHETTO 8-19 MM**

CARATTERISTICHE

- comprende i seguenti utensili attacco 1/4":
 - cricchetto reversibile
 - 13 bussole: 4 - 4,5 - 5 - 5,5 - 6 - 7 - 8 - 9 - 10 - 11 - 12 - 13 - 14 mm
 - 7 bussole lunghe: 4 - 5 - 6 - 7 - 8 - 9 - 10 mm
 - 5 bussole Torx femmina: E4 - E5 - E6 - E7 - E8
 - prolunghe: 50, 100 mm
 - snodo
 - impugnatura 150 mm
 - leva con quadro scorrevole
 - 33 bussole con maschio:
 - Taglio: 4,0 - 5,5 - 6,5 - 7,0 mm
 - Croce: PH: 0 - 1 - 2, PZ: 0 - 1 - 2
 - Esagono: 3 - 4 - 5 - 6 mm
 - Torx: TX8 - TX9 - TX10 - TX15 - TX20 - TX25 - TX27 - TX30
 - Torx c/foro: TH8 - TH9 - TH10 - TH15 - TH20 - TH25 - TH27 - TH30
 - XZN: M8 - M10 - M12
- comprende i seguenti utensili attacco 3/8":
 - cricchetto reversibile
 - 10 bussole: 10-11-12-13-14-15-16-17-18-19 mm
 - 6 bussole lunghe: 10-11-12-13-14-15 mm
 - 6 bussole Torx femmina: E10 - E11 - E12 - E14 - E16 - E18
 - prolunga: 125 mm
 - snodo
 - bussola per candele 18 mm
 - adattatore portainseri per inserti 5/16" (8 mm)
- comprende i seguenti utensili attacco 1/2":
 - cricchetto reversibile
 - 17 bussole: 10-11-12-13-14-15-16-17-18-19-20-21-22-24-27-30-32 mm
 - 2 bussole lunghe: 16-18 mm
 - 2 bussole Torx femmina: E20-E24
 - prolunga: 125 mm
 - prolunga: 250 mm con quadro scorrevole per uso come leva a T
 - snodo
 - bussole per candele 16 - 21 mm
 - adattatore portainseri per inserti 5/16" (8 mm)
 - bussole ricoperte per cerchi in lega: 17 - 19 - 21 mm
- inserti attacco 5/16":
 - 6 inserti Torx: TX40 - TX45 - TX50 - TX55 - TX60 - TX70
 - 6 inserti Torx c/foro: TH40 - TH45 - TH50 - TH55 - TH60 - TH70
 - Croce: PH: 3 - 4, PZ: 3 - 4
 - Esagonali: 7-8-10-12-14 mm
- chiavi a L:
 - 9 Torx c/ foro: TH10 - TH15 - TH20 - TH25 - TH27 - TH30 - TH40 - TH45 - TH50
 - 9 Esagonali: 1,5 - 2 - 2,5 - 3 - 4 - 5 - 6 - 8 - 10 mm
- 12 chiavi combinate a cricchetto: 8-9-10-11-12-13-14-15-16-17-18-19 mm
- peso: 13,0 kg

RICAMBI

BGS
 articolo

DESCRIZIONE

BGS 8820-LEER

CASSETTA VUOTA PER SET BGS 8820

BUSSOLE MULTIMPRONTA SPLINE DRIVE

218 PEZZI

BUSSOLE MULTIMPRONTA



**1/4"
3/8"
1/2"**

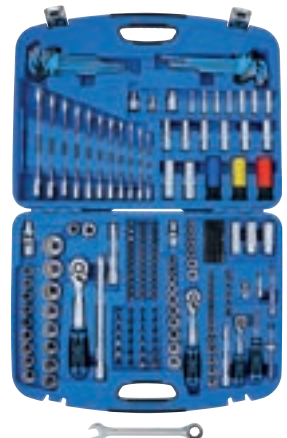

PRO+

BGS articolo	DESCRIZIONE
BGS 2290	CASSETTA 218 PEZZI, CHIAVI A BUSSOLA MULTIMPRONTA DA 1/4" - 3/8" - 1/2" + CHIAVI COMBinate A CRICCHETTO 8-19 MM

CARATTERISTICHE

- comprende i seguenti utensili attacco 1/4":
 - cricchetto reversibile 72 denti
 - 13 bussole: 4 - 4,5 - 5 - 5,5 - 6 - 7 - 8 - 9 - 10 - 11 - 12 - 13 - 14 mm
 - 7 bussole lunghe: 4 - 5 - 6 - 7 - 8 - 9 - 10 mm
 - 5 bussole Torx femmina: E4 - E5 - E6 - E7 - E8
 - prolunghe: 50, 100 mm
 - snodo
 - impugnatura 150 mm
 - leva con quadro scorrevole
 - 33 bussole con maschio:
 - Taglio: 4,0 - 5,5 - 6,5 - 7,0 mm
 - Croce: PH: 0 - 1 - 2, PZ: 0 - 1 - 2
 - Esagono: 3 - 4 - 5 - 6 mm
 - Torx: TX8 - TX9 - TX10 - TX15 - TX20 - TX25 - TX27 - TX30
 - Torx c/foro: TH8 - TH9 - TH10 - TH15 - TH20 - TH25 - TH27 - TH30
 - XZN: M8 - M10 - M12
- comprende i seguenti utensili attacco 3/8":
 - cricchetto reversibile 72 denti
 - 10 bussole: 10-11-12-13-14-15-16-17-18-19 mm
 - 6 bussole lunghe: 10-11-12-13-14-15 mm
 - 5 bussole Torx femmina: E10 - E11 - E12 - E14 - E16
 - prolunga: 125 mm
 - snodo
 - adattatore portainseriti per inserti 5/16" (8 mm)
- comprende i seguenti utensili attacco 1/2":
 - cricchetto reversibile 72 denti
 - 17 bussole: 10-11-12-13-14-15-16-17-18-19-20-21-22-24-27-30-32 mm
 - 2 bussole lunghe: 16-18 mm
 - 3 bussole Torx femmina: E18 - E20 - E24
 - prolunga: 125 mm
 - prolunga: 250 mm con quadro scorrevole per uso come leva a T
 - snodo
 - bussole per candele 16 - 18 - 21 mm
 - adattatore portainseriti per inserti 5/16" (8 mm)
 - bussole ricoperte per cerchi in lega: 17- 19 - 21 mm
- inserti attacco 5/16":
 - 3 Inserti Taglio: 8 - 10 - 12 mm
 - 6 inserti Torx: TX40 - TX45 - TX50 - TX55 - TX60 - TX70
 - 6 inserti Torx c/foro: TH40 - TH45 - TH50 - TH55 - TH60 - TH70
 - Croce: PH: 3 - 4, PZ: 3 - 4
 - Esagonali: 7-8-10-12-14 mm
- chiavi a L:
 - 9 Torx c/ foro: TH10 - TH15 - TH20 - TH25 - TH27 - TH30 - TH40 - TH45 - TH50
 - 9 Esagonali: 1,5 - 2 - 2,5 - 3 - 4 - 5 - 6 - 8 - 10 mm
- 12 chiavi combinate a cricchetto: 8-9-10-11-12-13-14-15-16-17-18-19 mm
- peso: 14,9 kg

RICAMBI

BGS articolo	DESCRIZIONE
BGS 2290-LEER	CASSETTA VUOTA PER SET BGS 2290

ESAGONALI

213 PEZZI

IDEALE PER ASSISTENZA E MANUTENZIONE AUTOMOTIVE



**1/4"
3/8"
1/2"**

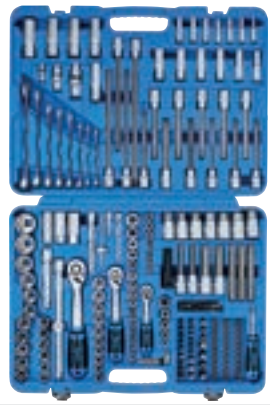

PRO+

BUSSOLE ESAGONALI



BGS articolo	DESCRIZIONE
BGS 2259	CASSETTA 213 PEZZI, CHIAVI A BUSSOLA ESAGONALI DA 1/4" - 3/8" - 1/2" + CHIAVI COMBinate A CRICCHETTO 8-19 MM

CARATTERISTICHE

- comprende i seguenti utensili attacco 1/4":
 - cricchetto reversibile
 - 13 bussole: 4 - 4,5 - 5 - 5,5 - 6 - 7 - 8 - 9 - 10 - 11 - 12 - 13 - 14 mm
 - 7 bussole lunghe: 4 - 5 - 6 - 7 - 8 - 9 - 10 mm
 - 5 bussole Torx femmina: E4 - E5 - E6 - E7 - E8
 - prolunghe: 50, 100 mm
 - snodo
 - impugnatura 150 mm
 - leva con quadro scorrevole
 - adattatore portainseriti per inserti att. 1/4"
 - bussole con maschio
- comprende i seguenti utensili attacco 3/8":
 - cricchetto reversibile 72 denti
 - 10 bussole: 10-11-12-13-14-15-16-17-18-19 mm
 - 6 bussole lunghe: 10-11-12-13-14-15 mm
 - 5 bussole Torx femmina: E10 - E11 - E12 - E14 - E16 - E18
 - prolunga: 125 mm
 - snodo
 - adattatore portainseriti per inserti 5/16" (8 mm) e 10 mm
 - bussola per candele: 18 mm
- comprende i seguenti utensili attacco 1/2":
 - cricchetto reversibile 72 denti
 - 17 bussole: 10-11-12-13-14-15-16-17-18-19-20-21-22-24-27-30-32 mm
 - 2 bussole lunghe: 16-17-18-19-22 mm
 - 3 bussole Torx femmina: E20 - E24
 - prolunga: 125, 250 mm
 - quadro scorrevole per uso come leva a T di prolunghe
 - snodo
 - bussole per candele: 16 - 21 mm
 - adattatore portainseriti per inserti 10 e 14 mm
- inserti attacco 14 mm:
 - inserti Torx: TX70 x 30 mm - TX70 x 115 mm
 - inserti Torx c/foro: TH70 x 30 mm
 - XZN: M14 x 40 mm - M14 x 115 mm
 - Esagonali: 14 mm x 30 mm - 13 mm x 115 mm
- inserti attacco 10 mm:
 - inserti Torx + Torx c/ foro: T55 - T60
 - Esagonali: 10-12 mm
- inserti attacco 5/16":
 - 3 Inserti Taglio: 8 - 10 - 12 mm
 - inserti Torx + Torx c/ foro: T40 - T45 - T50
 - Croce: PH: 3 - 4, PZ: 3 - 4
 - Esagonali: 7-8 mm
- inserti attacco 1/4":
 - Torx: TX5-TX6-TX7
 - Torx c/ foro: TH7
 - 5 Ribe: M5-M6-M7-M8-M9
 - 3 XZN: M5-M6-M8
 - 5 Punta con foro: TS10-TS15-TS20-TS25-TS27-TS30-TS40-TS45-TS50
 - Esagonali: 2-2,5 mm
- chiavi a L Esagonali: 1,27 - 1,5 - 2 - 2,5 - 3 - 4 - 5 mm
- chiavi combinate: 8-9-10-12-13-14-17-19 mm
- peso: 17,8 kg

SET 1/2"



38 PEZZI

1/4"
1/2"
**IDEALE PER
ASSISTENZA E
MANUTENZIONE
AUTOMOTIVE**

BGS articolo	DESCRIZIONE
BGS 5184	CASSETTA 38 PEZZI, CHIAVI A BUSSOLA TORX, TORX C/ FORO, XZN, RIBE, ESAGONALI, 5 PUNTE C/ FORO

CARATTERISTICHE

- n° 6 bussole Torx, attacco 1/2", lunghezza 140 mm:
TX40 - TX45 - TX50 - TX55 - TX60 - TX70
- n° 2 Torx C/Foro, attacco 1/2":
- TX30 X 300 mm
- TX80 X 100 mm
- n° 6 bussole XZN, attacco 1/2":
- M9 X 100 mm
- M10 X 140 mm
- M12 X 140 mm
- M14 X 140 mm
- M16 X 100 mm C/FORO
- M16 X 55 mm C/FORO
- n° 1 bussole XZN, attacco 1/2":
- M18 X 75 mm
- n° 4 bussole Ribe, attacco 1/2":
- M7 X 240 mm
- M8 X 240 mm
- M9 X 100 mm
- M10 X 140 mm
- n° 1 bussole Esagonali, attacco 1/2"
- 5 X 160 mm, testa sferica
- n° 9 bussole Esagonali, attacco 1/2":
- 10 X 140 mm
- 11 X 140 mm
- 13 X 140 mm
- 7 X 230 mm
- n° 5 Esagonale, attacco 1/2", lunghezza 50 mm:
- 14 - 17 - 19 - 22 - 24 mm
- n° 9 bussole, 5 punte c/foro, attacco 1/4", lunghezza 38 mm:
- TS10 - TS15 - TS20 - TS25 - TS27 - TS30 - TS40 - TS45 - TS50
- all'interno della cassetta informazioni sull'utilizzo delle chiavi per ogni modello di auto
- peso: 6,5 kg

POLIGONALE TORX®

1/4" 1/4" 3/8" 1/2"

FERMEC articolo	DESCRIZIONE
24260	SET 23 PEZZI, CHIAVI EXTRA-LUNGHE CON BUSSOLE E ADATTATORI

CARATTERISTICHE

- chiavi a cricchetto extra-lunghe da 14 e 17 mm, lunghezza 395 mm, anello+cricchetto poligonale con snodo 180°
- chiavi a bussola poligonali:
- attacco esagonale 14 mm: 10, 11, 12, 13, 14 mm
- attacco esagonale 17 mm: 15, 16, 17, 18, 19 mm
- chiavi a bussola poligonali lunghezza 63 mm:
- attacco esagonale 14 mm: 14 mm
- attacco esagonale 17 mm: 17 mm
- chiavi a bussola Torx femmina:
- attacco esagonale 14 mm: E8, E10, E12, E14
- attacco esagonale 17 mm: E16, E18, E20, E22, E22
- adattatore porta inserti:
- attacco esagonale 14 mm - 1/4"
- adattatori porta bussole:
- attacco esagonale 14 mm - 1/4"
- attacco esagonale 17 mm - 3/8
- attacco esagonale 17 mm - 1/2"
- 10 OR di ricambio per chiavi att. esagonale 14 mm
10 OR di ricambio per chiavi att. esagonale 17 mm

RICAMBI

FERMEC articolo	DESCRIZIONE
24260-10 DSKT	BUSSOLA POLIG. 10 MM
24260-11 DSKT	BUSSOLA POLIG. 11 MM
24260-12 DSKT	BUSSOLA POLIG. 12 MM
24260-13 DSKT	BUSSOLA POLIG. 13 MM
24260-14 DSKT	BUSSOLA POLIG. 14 MM
24260-15 DSKT	BUSSOLA POLIG. 15 MM
24260-16 DSKT	BUSSOLA POLIG. 16 MM
24260-17 DSKT	BUSSOLA POLIG. 17 MM
24260-18 DSKT	BUSSOLA POLIG. 18 MM
24260-19 DSKT	BUSSOLA POLIG. 19 MM
24260-CRICCO 14	CHIAVE A CRICCHETTO 14 MM, L. 395 MM
24260-CRICCO 17	CHIAVE A CRICCHETTO 17 MM, L. 395 MM

ESAGONALI

BUSSOLE
ESAGONALI



1/4"
3/8"
1/2"

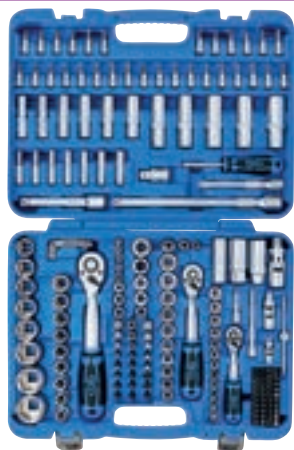

CV

PRO+

BGS
articolo
BGS 2243

DESCRIZIONE

CASSETTA 192 PEZZI, CHIAVI A BUSSOLA
ESAGONALI DA 1/4" - 3/8" - 1/2"

CARATTERISTICHE

- comprende i seguenti utensili attacco 1/4":
 - cricchetto reversibile 72 denti
 - 13 bussole: 4 - 4,5 - 5 - 5,5 - 6 - 7 - 8 - 9 - 10 - 11 - 12 - 13 - 14 mm
 - 7 bussole lunghe: 4 - 5 - 6 - 7 - 8 - 9 - 10 mm
 - 5 bussole Torx femmina: E4 - E5 - E6 - E7 - E8
 - prolunghe: 50, 100 mm
 - snodo
 - impugnatura 150 mm
 - leva con quadro scorrevole
 - adattatore portainseriti per inserti att. 1/4"
 - bussole con maschio:
 - Taglio: 4,0 - 5,5 - 6,5 - 7,0 mm
 - Croce: PH: 0 - 1 - 2, PZ: 0 - 1 - 2
 - Esagono: 3 - 4 - 5 - 6 mm
 - Torx: TX8 - TX9 - TX10 - TX15 - TX20 - TX25 - TX27 - TX30
 - Torx c/foro: TH8 - TH9 - TH10 - TH15 - TH20 - TH25 - TH27 - TH30
- comprende i seguenti utensili attacco 3/8":
 - cricchetto reversibile 72 denti
 - 10 bussole: 10-11-12-13-14-15-16-17-18-19 mm
 - 6 bussole lunghe: 10-11-12-13-14-15 mm
 - 5 bussole Torx femmina: E10 - E11 - E12 - E14 - E16
 - prolunga: 125 mm
 - snodo
 - adattatore portainseriti per inserti 5/16" (8 mm)
 - bussola per candele: 18 mm
- comprende i seguenti utensili attacco 1/2":
 - cricchetto reversibile 72 denti
 - 17 bussole: 10-11-12-13-14-15-16-17-18-19-20-21-22-24-27-30-32 mm
 - 2 bussole lunghe: 16-17-18-19-22 mm
 - 3 bussole Torx femmina: E18 - E20 - E24
 - prolunga: 125, 250 mm
 - quadro scorrevole per uso come leva a T di prolunghe
 - snodo
 - bussole per candele: 16 - 21 mm
 - adattatore portainseriti per inserti 5/16" (8 mm)
- inserti attacco 5/16":
 - 3 Inserti Taglio: 8 -10 - 12 mm
 - 6 inserti Torx: TX40 - TX45 - TX50 - TX55 - TX60 - TX70
 - 6 inserti Torx c/foro: TH40 - TH45 - TH50 - TH55 - TH60 - TH70
 - Croce: PH: 3 - 4, PZ: 3 - 4
 - Esagonali: 7-8-10-12-14 mm
- inserti attacco 1/4":
 - Torx: TX5-TX6-TX7-TX10-TX15-TX20-TX25-TX27-TX30-TX40
 - Torx c/ foro: TH5-TH6-TH7-TH10-TH15-TH20-TH25-TH27-TH30-TH40
 - 5 Ribe: M5-M6-M7-M8-M9
 - 3 XZN: M5-M6-M8
 - 5 Punte con foro: TS7-TS10-TS15-TS20-TS25-TS27-TS30-TS40-TS45
 - Croce: PH: 3 - 4, PZ: 3 - 4
 - Esagonali: 2-2,5 mm
- chiavi a L Esagonali: 1 - 1,5 - 2 - 2,5 - 3 - 4 - 5 mm
- peso: 9,0 kg

POLIGONALI

BUSSOLE
POLIGONALI



1/4"
3/8"
1/2"

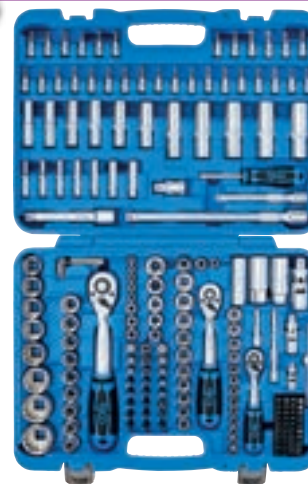

CV

PRO+

BGS
articolo
BGS 2286

DESCRIZIONE

CASSETTA 192 PEZZI, CHIAVI A BUSSOLA
POLIGONALI DA 1/4" - 3/8" - 1/2"

CARATTERISTICHE

- comprende i seguenti utensili attacco 1/4":
 - cricchetto reversibile 72 denti
 - 13 bussole: 4 - 4,5 - 5 - 5,5 - 6 - 7 - 8 - 9 - 10 - 11 - 12 - 13 - 14 mm
 - 7 bussole lunghe: 4 - 5 - 6 - 7 - 8 - 9 - 10 mm
 - 5 bussole Torx femmina: E4 - E5 - E6 - E7 - E8
 - prolunghe: 50, 100 mm
 - snodo
 - impugnatura 150 mm
 - leva con quadro scorrevole
 - adattatore portainseriti per inserti att. 1/4"
 - bussole con maschio:
 - Taglio: 4,0 - 5,5 - 6,5 - 7,0 mm
 - Croce: PH: 0 - 1 - 2, PZ: 0 - 1 - 2
 - Esagono: 3 - 4 - 5 - 6 mm
 - Torx: TX8 - TX9 - TX10 - TX15 - TX20 - TX25 - TX27 - TX30
 - Torx c/foro: TH8 - TH9 - TH10 - TH15 - TH20 - TH25 - TH27 - TH30
- comprende i seguenti utensili attacco 3/8":
 - cricchetto reversibile 72 denti
 - 10 bussole: 10-11-12-13-14-15-16-17-18-19 mm
 - 6 bussole lunghe: 10-11-12-13-14-15 mm
 - 5 bussole Torx femmina: E10 - E11 - E12 - E14 - E16 - E18
 - prolunga: 125 mm
 - snodo
 - adattatore portainseriti per inserti 5/16" (8 mm)
 - bussola per candele: 18 mm
- comprende i seguenti utensili attacco 1/2":
 - cricchetto reversibile 72 denti
 - 17 bussole: 10-11-12-13-14-15-16-17-18-19-20-21-22-24-27-30-32 mm
 - 2 bussole lunghe: 16-17-18-19-22 mm
 - 3 bussole Torx femmina: E20 - E24
 - prolunga: 125, 250 mm
 - quadro scorrevole per uso come leva a T di prolunghe
 - snodo
 - bussole per candele: 16 - 21 mm
 - adattatore portainseriti per inserti 5/16" (8 mm)
- inserti attacco 5/16":
 - 3 Inserti Taglio: 8 -10 - 12 mm
 - 6 inserti Torx: TX40 - TX45 - TX50 - TX55 - TX60 - TX70
 - 6 inserti Torx c/foro: TH40 - TH45 - TH50 - TH55 - TH60 - TH70
 - Croce: PH: 3 - 4, PZ: 3 - 4
 - Esagonali: 7-8-10-12-14 mm
- inserti attacco 1/4":
 - Torx: TX5-TX6-TX7
 - 5 Ribe: M5-M6-M7-M8-M9
 - 3 XZN: M5-M6-M8
 - 5 Punte con foro: TS7-TS10-TS15-TS20-TS25-TS27-TS30-TS40-TS45
 - Croce: PH: 3 - 4, PZ: 3 - 4
 - Esagonali: 2-2,5 mm
- chiavi a L Esagonali: 1 - 1,5 - 2 - 2,5 - 3 - 4 - 5 mm
- peso: 8,8 kg

SET 0 1/2"

POLLICI

192 PEZZI
**BUSSOLE
ESAGONALI**

**1/4"
3/8"
1/2"**
PRO+
CV
BGS
 articolo

DESCRIZIONE
BGS 2245
**CASSETTA 192 PEZZI, CHIAVI A BUSSOLA
ESAGONALI DA 1/4" - 3/8" - 1/2", IN POLLICI**
CARATTERISTICHE

- chiavi a L Esagonali: 1.27 - 1.5 - 2 - 2.5 - 3 - 4 - 5 mm
- inserti attacco 5/16":
 - Taglio: 8 - 10 - 12 mm
 - PH: PH3 - PH4 - PZ3 - PZ4
 - Esagonali: 9/32"-5/16"-3/8"-15/32"-9/16"
 - Torx: TX 40 - 45 - 50 - 55 - 60 - 70
 - Torx c/ foro: TH 40 - 45 - 50 - 55 - 60 - 70
- inserti attacco 1/4":
 - Torx: TX 5 - 6 - 7 - 10 - 15 - 20 - 25 - 27 - 30 - 40
 - Torx c/foro: TH 7 - 10 - 15 - 20 - 25 - 27 - 30 - 40
 - Ribe: 5 - 6 - 7 - 8 - 9
 - XZN: 5 - 6 - 8
 - 5 Punte con foro: TS 10 - 15 - 20 - 25 - 27 - 30 - 40 - 45
 - PH: PH1 - PH2 - PZ1 - PZ2
 - Esagonali: 2 - 2.5 mm
- comprende i seguenti utensili attacco 1/4":
 - cricchetto reversibile
 - leva con quadro scorrevole
 - prolunghe: 50, 100 mm
 - snodo
 - impugnatura 150 mm
 - bussole: 5/32"-3/16"-3/16"-7/32"-1/4"-9/32"-5/16"-11/32"-3/8"-7/16"-15/32"-1/2"-9/16"
 - bussole lunghe: 5/32"-3/16"-1/4"-9/32"-5/16"-11/32"-3/8"
 - 5 bussole Torx femmina: E4 - E5 - E6 - E7 - E8
 - adattatore portainseriti per inserti att. 1/4"
 - bussole con maschio:
 - Torx: TX8-9-10-15-20-25-27-30
 - Torx c/foro: TH8-9-10-15-20-25-27-30
 - Esagonali: 3-4-5-6 mm
 - PH: PH0-PH1-PH2
 - PZ: PZ0-PZ1-PZ2
 - Taglio: 4-5-5-6-5-7 mm
- comprende i seguenti utensili attacco 3/8":
 - cricchetto reversibile
 - prolunga: 125 mm
 - snodo
 - bussola per candele: 18 mm
 - bussole: 3/8"-7/16"-15/32"-1/2"-9/16"-19/32"-5/8"-11/16"-3/4"-25/32"
 - bussole lunghe: 3/8"-7/16"-15/32"-1/2"-9/16"-19/32"
 - 5 bussole Torx femmina: E10 - E11 - E12 - E14 - E16 - E18
- comprende i seguenti utensili attacco 1/2":
 - cricchetto reversibile
 - prolunga: 125, 250 mm
 - quadro scorrevole per uso come leva a T di prolunghe
 - adattatore portainseriti per inserti 5/16"
 - snodo
 - bussole per candele: 16 - 21 mm
 - 17 bussole: 3/8"-7/16"-15/32"-1/2"-9/16"-19/32"-5/8"-21/32"-11/16"-3/4"-25/32"-13/16"-7/8"-15/16"-1-1/16"-1-3/16"-1-1/4"
 - 2 bussole lunghe: 5/8", 11/16", 3/4", 13/16", 7/8"
 - bussole Torx femmina: E20 - E24
- peso: 8,9 kg

**SURFACE
DRIVE**
**BUSSOLE
SURFACE DRIVE**

**1/4"
3/8"
1/2"**
CV
PRO+
BGS
 articolo

DESCRIZIONE
BGS 2292
**CASSETTA 192 PEZZI, CHIAVI A BUSSOLA
SURFACE DRIVE DA 1/4" - 3/8" - 1/2"**
CARATTERISTICHE

- comprende i seguenti utensili attacco 1/4":
 - cricchetto reversibile 72 denti
 - 13 bussole: 4 - 4,5 - 5 - 5,5 - 6 - 7 - 8 - 9 - 10 - 11 - 12 - 13 - 14 mm
 - 7 bussole lunghe: 4 - 5 - 6 - 7 - 8 - 9 - 10 mm
 - 5 bussole Torx femmina: E4 - E5 - E6 - E7 - E8
 - prolunghe: 50, 100 mm
 - snodo
 - impugnatura 150 mm
 - leva con quadro scorrevole
 - adattatore portainseriti per inserti att. 1/4"
 - bussole con maschio
- comprende i seguenti utensili attacco 3/8":
 - cricchetto reversibile 72 denti
 - 10 bussole: 10-11-12-13-14-15-16-17-18-19 mm
 - 6 bussole lunghe: 10-11-12-13-14-15 mm
 - 5 bussole Torx femmina: E10 - E11 - E12 - E14 - E16
 - prolunga: 125 mm
 - snodo
 - adattatore portainseriti per inserti 5/16" (8 mm)
 - bussola per candele: 18 mm
- comprende i seguenti utensili attacco 1/2":
 - cricchetto reversibile 72 denti
 - 17 bussole: 10-11-12-13-14-15-16-17-18-19-20-21-22-24-27-30-32 mm
 - 2 bussole lunghe: 16-17-18-19-22 mm
 - 3 bussole Torx femmina: E18 - E20 - E24
 - prolunga: 125, 250 mm
 - quadro scorrevole per uso come leva a T di prolunghe
 - snodo
 - bussole per candele: 16 - 21 mm
 - adattatore portainseriti per inserti 5/16" (8 mm)
- inserti attacco 5/16":
 - 3 Inserti Taglio: 8 - 10 - 12 mm
 - 6 inserti Torx: TX40 - TX45 - TX50 - TX55 - TX60 - TX70
 - 6 inserti Torx c/foro: TH40 - TH45 - TH50 - TH55 - TH60 - TH70
 - Croce: PH: 3 - 4, PZ: 3 - 4
 - Esagonali: 7-8-10-12-14 mm
- inserti attacco 1/4":
 - 3 Inserti Taglio: 8 - 10 - 12 mm
 - 10 inserti Torx: TX5-TX6-TX7-TX10-TX15-TX20-TX25-TX27-TX30-TX40
 - 8 inserti Torx c/foro: TH7-TH10-TH15-TH20-TH25-TH27-TH30-TH40
 - 5 Ribe: M5-M6-M7-M8-M9
 - 3 XZN: M5-M6-M8
 - 5 Punte con foro: TS10-TS15-TS20-TS25-TS27-TS30-TS40-TS45
 - Croce: PH: 3 - 4, PZ: 3 - 4
 - Esagonali: 2-2.5 mm
- chiavi a L Esagonali: 1 - 1,5 - 2 - 2,5 - 3 - 4 - 5 mm
- peso: 8,8 kg

RICAMBI
BGS
 articolo

DESCRIZIONE
BGS 2292-LEER
CASSETTA VUOTA PER SET BGS 2292

SURFACE DRIVE

172 PEZZI

BUSSOLE SURFACE DRIVE



1/4"
3/8"
1/2"



BGS
articolo

DESCRIZIONE

BGS 2283

CASSETTA 172 PEZZI, CHIAVI A BUSSOLA SURFACE DRIVE DA 1/4" - 3/8" - 1/2"

CARATTERISTICHE

- comprende i seguenti utensili attacco 1/4":
 - cricchetto reversibile
 - 13 bussole: 4 - 4,5 - 5 - 5,5 - 6 - 7 - 8 - 9 - 10 - 11 - 12 - 13 - 14 mm
 - 7 bussole lunghe: 4 - 5 - 6 - 7 - 8 - 9 - 10 mm
 - 5 bussole Torx femmina: E4 - E5 - E6 - E7 - E8
 - prolunghe: 50, 100 mm
 - snodo
 - impugnatura 150 mm
 - leva con quadro scorrevole
 - adattatore portainseri per inserti att. 1/4"
 - 30 bussole con maschio
- comprende i seguenti utensili attacco 3/8":
 - cricchetto reversibile
 - 10 bussole: 10-11-12-13-14-15-16-17-18-19 mm
 - 6 bussole lunghe: 10-11-12-13-14-15 mm
 - 6 bussole Torx femmina: E10 - E11 - E12 - E14 - E16 - E18
 - prolunga: 125 mm
 - snodo
 - adattatore portainseri per inserti 5/16" (8 mm)
 - bussola per candele: 18 mm
- comprende i seguenti utensili attacco 1/2":
 - cricchetto reversibile
 - 17 bussole: 10-11-12-13-14-15-16-17-18-19-20-21-22-24-27-30-32 mm
 - 2 bussole lunghe: 16-17-18-19-22 mm
 - 2 bussole Torx femmina: E18 - E20 - E24
 - prolunga: 125, 250 mm
 - quadro scorrevole per uso come leva a T di prolunghe
 - snodo
 - bussole per candele: 16 - 21 mm
 - adattatore portainseri per inserti 5/16" (8 mm)
- 24 inserti attacco 5/16":
 - 3 Inserti Taglio: 8 - 10 - 12 mm
 - 6 inserti Torx: TX40 - TX45 - TX50 - TX55 - TX60 - TX70
 - 6 inserti Torx c/foro: TH40 - TH45 - TH50 - TH55 - TH60 - TH70
 - Croce: PH: 3 - 4, PZ: 3 - 4
 - Esagonali: 7-8-10-12-14 mm
- 20 inserti attacco 1/4":
 - 3 Inserti Taglio: 8 - 10 - 12 mm
 - 10 inserti Torx: TX5-TX6-TX7-TX10-TX15-TX20-TX25-TX27-TX30-TX40
 - 8 inserti Torx c/foro: TH7-TH10-TH15-TH20-TH25-TH27-TH30-TH40
 - 5 Ribe: M5-M6-M7-M8-M9
 - 3 XZN: M5-M6-M8
 - 5 Punte con foro: TS10-TS15-TS20-TS25-TS27-TS30-TS40-TS45
 - Croce: PH: 3 - 4, PZ: 3 - 4
 - Esagonali: 2-2,5 mm
- chiavi a L Esagonali: 1,2 - 5 mm
- peso: 8,9 kg

RICAMBI

BGS
articolo

DESCRIZIONE

BGS 2283-LEER

CASSETTA VUOTA PER SET BGS 2283

192 PEZZI



BUSSOLE MULTIMPRONTA



1/4"
3/8"
1/2"



PRO+

BGS
articolo

DESCRIZIONE

BGS 2247

CASSETTA 192 PEZZI, CHIAVI A BUSSOLA MULTIMPRONTA DA 1/4" - 3/8" - 1/2"

CARATTERISTICHE

- bussole "multimpronta" attacco 1/2" adatte per dadi esagonali, poligonali, misure metriche & pollici, quadri, XZN®, TORX®
- utensili conformi DIN
- attacco quadro: 1/4" , 3/8" e 1/2"
- comprende i seguenti utensili attacco 1/4":
 - cricchetto reversibile, 72 denti, con pulsante di sgancio rapido
 - leva con quadro scorrevole
 - prolunghe: 50, 100 mm
 - snodo
 - impugnatura 150 mm
 - 13 bussole "Multimpronta": 4-4,5-5-5,5-6-7-8-9-10-11-12-13-14 mm
 - 7 bussole lunghe "Multimpronta": 4-5-6-7-8-9-10 mm
 - 5 bussole tipo Torx femmina: E4-5-6-7-8
 - 1 adattatore portainseri 1/4" esagonale
 - bussole con maschio
 - PH0-1-2, PZ0-1-2
 - Taglio: 4-5-5-6-5-7 mm
 - Esagono: 3-4-5-6 mm
 - Torx: TX8-TX9-TX10-TX15-TX20-TX25-TX27-TX30
 - Torx con foro: TH8-TH9-TH10-TH15-TH20-TH25-TH27-TH30
- comprende i seguenti utensili attacco 3/8":
 - cricchetto reversibile, 72 denti, con pulsante di sgancio rapido
 - prolunga 125 mm
 - snodo
 - bussola per candele 18 mm
 - 10 bussole "Multimpronta": 10-11-12-13-14-15-16-17-18-19 mm
 - 6 bussole lunghe "Multimpronta": 10-11-12-13-14-15 mm
 - bussole tipo Torx femmina: E10-11-12-14-16
 - adattatore portainseri 5/16" (8 mm)
- comprende i seguenti utensili attacco 1/2":
 - cricchetto reversibile, 72 denti, con pulsante di sgancio rapido
 - prolunghe: 125, 250 mm
 - adattatore quadro scorrevole per uso come leva a T
 - adattatore portainseri 5/16" (8 mm)
 - snodo
 - bussole per candele: 16-21 mm
 - 17 bussole "Multimpronta": 10-11-12-13-14-15-16-17-18-19-20-21-22-24-27-30-32 mm
 - 5 bussole lunghe "Multimpronta": 16-17-18-19-22 mm
 - bussole tipo Torx femmina: E18-20-24
- inserti attacco 5/16" (8 mm):
 - Taglio: 8-10-12 mm
 - PH3-PH4-PZ3-PZ4
 - Esagono: 7-8-10-12-14 mm
 - Torx: TX40-TX45-TX50-TX55-TX60-TX70
 - Torx con foro: TH40-TH45-TH50-TH55-TH60-TH70
- inserti attacco 1/4":
 - Torx: TX5-TX6-TX7-TX10-TX15-TX20-TX25-TX27-TX30-TX40
 - Torx con foro: TH7-TH10-TH15-TH20-TH25-TH27-TH30-TH40
 - RIBE: M5-6-7-8-9, XZN: M5-6-8
 - 5 punte con foro: TS10-TS15-TS20-TS25-TS27-TS30-TS40-TS45
 - PH3-PH4-PZ3-PZ4
 - Esagono: 2-2,5 mm
- 7 chiavi a L: 1-1,5-2-2,5-3-4-5 mm
- peso: 8,7 kg

SET 1/2"



126 PEZZI



1000 V

CV



1/2"

articolo

DESCRIZIONE

FM 901

**SET 26 PEZZI,
 UTENSILI ISOLATI VDE, IN VALIGETTA IN
 PLASTICA, ATT. 1/2"**

CARATTERISTICHE

- conformi DIN EN 60900
- isolati VDE fino a 1000 V
- comprende:
 - pinze professionali, 200 mm
 - tronchese taglio diagonale, 160 mm
 - pinze a becchi mezzotondi dritte, 200 mm
 - cricchetto reversibile, att. 1/2"
 - prolunga att. 1/2", 250 mm
 - coltello per cavi isolato
 - coltello per cavi isolato con punta arrotondata
 - bussole esagonali, att. 1/2": 10 - 11 - 12 - 13 - 14 - 17 - 19 mm
 - chiavi a forchetta: 10 - 11 - 12 - 13 - 14 - 17 - 19 mm
 - tester di tensione universale
 - cacciaviti taglio: 3,5 X 100 - 5,5 X 125 - 6,5 X 150 - 8 X 175 mm



10 PEZZI

PRO+



1000 V

CV



3/8"



1/2"

articolo

DESCRIZIONE

BGS 7132

**SET 10 PEZZI,
 CHIAVI A BUSSOLA ESAGONALI, 4-10 MM,
 UTENSILI ISOLATI VDE, ATT. 3/8 - 1/2"**

CARATTERISTICHE

- conformi DIN EN 60900
- isolati VDE fino a 1000 V
- comprende:
 - chiavi a bussola, attacco quadro femmina 3/8", lunghezza 68 mm, Esagono maschio: 4 - 5 - 6 - 7 mm
 - chiavi a bussola, attacco quadro femmina 1/2", lunghezza 92 mm, Esagono maschio: 6 - 7 - 8 - 10 mm
 - chiave a T, attacco quadro maschio 1/2", lunghezza 205 mm
 - adattatore, attacco quadro femmina 1/2", attacco quadro maschio 3/8"
- peso: 2,3 kg



10 PEZZI

PRO+



1000 V

CV



1/2"

articolo

DESCRIZIONE

BGS 7131

**SET 10 PEZZI,
 CHIAVI A BUSSOLA TORX, TX20 - TX55,
 UTENSILI ISOLATI VDE,
 ATT. 1/2"**

CARATTERISTICHE

- conformi DIN EN 60900
- isolati VDE fino a 1000 V
- comprende:
 - chiavi a bussola, attacco quadro femmina 1/2", lunghezza 95 mm, TORX: TX20 - TX25 - TX27 - TX30 - TX40 - TX45 - TX47 - TX50 - TX55
 - chiave a T, attacco quadro maschio 1/2", lunghezza 205 mm
- peso: 2,4 kg



12 PEZZI

PRO+



1000 V

CV



3/8"

articolo

DESCRIZIONE

BGS 7133

**SET 12 PEZZI,
 BUSSOLE ESAGONALI, 7-22 MM,
 UTENSILI ISOLATI VDE, ATT. 3/8 - 1/2"**

CARATTERISTICHE

- conformi DIN EN 60900
- isolati VDE fino a 1000 V
- comprende:
 - bussole, attacco quadro femmina 3/8", lunghezza 72 mm, Esagono: 7 - 8 - 10 - 12 - 14 - 15 - 17 - 19 - 22 mm
 - chiave a T, attacco quadro maschio 3/8", lunghezza 210 mm
 - prolunga, 118 mm
 - cricchetto reversibile, attacco 3/8" (BGS 701)
- peso: 2,3 kg



BGS articolo	DESCRIZIONE
BGS 7134	SET 11 PEZZI, BUSSOLE ESAGONALI, UTENSILI ISOLATI VDE ATT. 1/2", 10-24 MM,

CARATTERISTICHE

- conformi DIN EN 60900
- isolati VDE fino a 1000 V
- comprende:
 - bussole, attacco quadro femmina 1/2", lunghezza 92 mm, Esagono: 10 - 12 - 13 - 14 - 17 - 19 - 22 - 24 mm
 - chiave a T, attacco quadro maschio 1/2", lunghezza 205 mm
 - prolunga, 142 mm
 - cricchetto reversibile, attacco 1/2" (BGS 702)
- peso 3,8 kg



novità

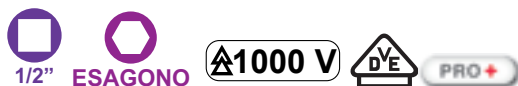

BGS articolo	DESCRIZIONE
BGS 7145	SET 11 PEZZI, BUSSOLE VDE, ATTACCO 1/2", 10 - 24 MM

CARATTERISTICHE

- ideale per l'utilizzo su impianti elettrici o per i lavori di riparazione e manutenzione di veicoli ibridi ed elettrici
- comprende utensili isolati conformi DIN EN/IEC 60900
- in cassetta con modulo in schiuma EPE
- modulo portautensili in schiuma ad alta resistenza
- materiale: acciaio al cromo vanadio
- conformità standard DIN: EN 60900
- impronta: esagonale
- attacco quadro: 1/2"
- finitura: Isolamento VDE
- comprende:
 - bussole isolate VDE, lunghe, attacco 1/2": 10 mm - 12 mm - 13 mm - 14 mm - 17 mm - 19 mm - 22 mm - 24 mm
 - 1 prolunga isolata VDE, attacco 1/2", lunghezza 125 mm
 - 1 impugnatura a T, attacco 1/2", lunghezza 210 mm
 - 1 cricchetto reversibile isolato VDE, attacco 1/2", 1000 V (BGS 626)
- peso: 4,4 kg



55 PEZZI

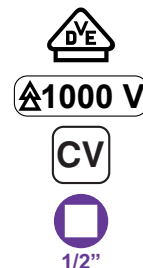

FERMEC articolo	DESCRIZIONE
FM 820	SET 55 PEZZI, UTENSILI ISOLATI VDE, IN VALIGETTA, ATT. 1/2"

CARATTERISTICHE

- conformi DIN EN 60900
- isolati VDE fino a 1000 V
- comprende:
 - valigetta 440 x 350 x 190 mm
 - pinze professionali, 185 mm
 - pinze spellafili, 160 mm
 - pinze a becchi mezzotondi dritte, 200 mm
 - tronchese taglio diagonale, 160 mm
 - tagliacavi, 215 mm
 - chiavi a forchetta: 10 - 13 - 14 - 17 - 19 - 22 mm
 - cricchetto reversibile, att. 1/2", 260 mm
 - prolunghe att. 1/2": 125 - 250 mm
 - chiave a "T", att. 1/2", 200 mm
 - bussole esagonali, att. 1/2": 10 - 11 - 12 - 13 - 14 - 17 - 19 - 22 - 24 mm
 - coltello per cavi isolato
 - coltello per cavi isolato con punta arrotondata
 - 3 tappeti 130 x 130 mm
 - 3 tappeti 250 x 350 mm
 - 3 tappeti 500 x 500 mm
 - 2 pinze per teli 160 mm
 - 4 pinze per teli 80 mm
 - 1 paio di guanti isolati, misura 9
 - 1 paio di sotto-guanti
 - cacciaviti taglio: 2,8 X 75 - 4 X 100 - 5,5 X 125 - 6,5 X 150 mm



BUSSOLE SPECIALI "POWER IMPACT"
DOPPIA MISURA
 CON RIVESTIMENTO ESTERNO IN
 MATERIALE PLASTICO
 IDEALE PER AVVITARE BULLONI CROMATI
 DELLE RUOTE DI AUTOVEICOLI CON
 CERCHI IN LEGA

attacco: 1/2"
 impronta: ESAGONO

FEEMEC articolo	mm	L mm	
FM 17190	17 X 19	78	1
FM 21220	21 X 22	78	1

POLLICI

FM 341316 3/4" X 13/16" 78 1



ESAGONO 1/2" ESAGONO

FEEMEC articolo	DESCRIZIONE
FM 17220	SET 3 PEZZI BUSSOLE RIVESTITE DOPPIA MISURA + PROLUNGA, ATT. 1/2"

CARATTERISTICHE

- lunghezza:
 - bussole 78 mm
 - prolunga 75 mm
- bussole speciali "POWER IMPACT" con rivestimento esterno in materiale plastico
- ideali per avvitare bulloni cromati delle ruote di autoveicoli CON CERCHI IN LEGA
- misure: 17 x 19 - 21 x 22 mm



BUSSOLE ESAGONALI DOPPIE PER DADI RUOTE

FEEMEC articolo	mm	1/2"	PER
FM 165175	16,5 + 17,5	1/2"	FIAT & JEEP
FM 185195	18,5 + 19,5	1/2"	FORD
FM 21215	21,0 + 21,5	1/2"	FORD GALAXY, VOLVO & TOYOTA
FM 22225	22,0 + 22,5	1/2"	CHRYSLER DODGE, LAND ROVER & RANGE ROVER
FM 27275	27,0 + 27,5	1/2"	LAND ROVER DISCOVERY & RANGE ROVER

CARATTERISTICHE

- FM 165175: per Jeep
- FM 185195: per dadi rivestiti cromati Ford da 19 mm
- FM 21215: per dadi rivestiti cromati Ford Galaxy
- impronta esagonale
- misure:
 - FM 165175: 16,5 + 17,5 mm
 - FM 185195: 18,5 + 19,5 mm
 - FM 21215: 21 + 21,5 mm
 - FM 22225: 22 + 22,5 mm
 - FM 27275: 27 + 27,5 mm
- lunghezza 63 mm





ESAGONO
1/2"
ESAGONO

CHIAVI A BUSSOLA A MACCHINA DOPPIO ESAGONO

Koken articolo	mm	D mm	L mm	
14118M-17X19	17x19	28	48	1
14118M-19X21	19x21	31	57	1
14118M-19X22	19x22	31	57	1

DESCRIZIONE

14218 SET CHIAVE A BUSSOLA A MACCHINA DOPPIO ESAGONO CON PROLUNGA

RICAMBI

BUSSOLE		
ESAGONO	14118M	19 X 21
	14760 ST-B	

DESCRIZIONE

FM 185275 SET 5 PEZZI BUSSOLE PER DADI RUOTE, CON PROLUNGA, ATT. 1/2"

CARATTERISTICHE

- bussole esagonali doppia misura, att. 1/2", lunghezza 63 mm:
 - **FM 185195**: 18,5 + 19,5 mm, per FORD
 - **FM 21215**: 21 + 21,5 mm, per FORD GALAXY, VOLVO & TOYOTA
 - **FM 22225**: 22 + 22,5 mm, per CHRYSLER DODGE, LAND ROVER & RANGE ROVER
 - **FM 27275**: 27 + 27,5 mm, per LAND ROVER DISCOVERY & RANGE ROVER
- prolunga att. 1/2", lunghezza 75 mm

DESCRIZIONE

BGS 9270 BUSSOLA SPECIALE 5 LATI, PER BULLONI DI SICUREZZA TOYOTA E LEXUS

CARATTERISTICHE

- dimensioni: 23 mm x 5 lati
- anche per uso con avvitatore
- peso: 300 g

DESCRIZIONE

BGS 7309 CON RIVESTIMENTO IN PLASTICA

CARATTERISTICHE

- chiave per allentare o avvitare dadi o viti ruote con profilo Socket MS 17. montate su Mercedes
- diametro: 27 mm
- rivestita in plastica: particolarmente idonea in presenza di cerchi in alluminio
- lunghezza: 78 mm

IMPACT AUTOMOTIVE 1/2"



PRO+

BGS
articolo

DESCRIZIONE

BGS 9371

BUSSOLA CON RIVESTIMENTO IN PLASTICA, 21 MM, PER BULLONI HYUNDAI I30, TUCSON & KIA

CARATTERISTICHE

- bussola rivestita in plastica, particolarmente idonea in presenza di cerchi in alluminio
- adatta per uso con avvitatori
- peso: 260 g

POLLICI



1/2"

ESAGONO

Jeep

FERMEC
articolo

DESCRIZIONE

197-11/16 L

BUSSOLA ESAGONALE PER DADI RUOTE, PER JEEP RENEGADE

CARATTERISTICHE

- attacco 1/2"
- impronta esagonale
- misura in pollici 11/16"
- misura metrica: 17,5 mm
- per Jeep
- lunghezza 85 mm

novità



1/2"

ESAGONO



PRO+

BGS
articolo

DESCRIZIONE

BGS 7319

BUSSOLA CON RIVESTIMENTO IN PLASTICA, PER TESLA, ATT. 1/2", 7/8"

CARATTERISTICHE

- ideale per l'installazione e la rimozione dei bulloni delle ruote Tesla
- per uso a mano e a macchina
- con scanalatura e foro per spina
- ricoperte in plastica per prevenire danni ai cerchi
- attacco quadro: 1/2"
- lunghezza: 85 mm
- materiale: acciaio al cromo molibdeno
- misura: 7/8"
- peso 390 g

POLLICI

JAPAN



1/2"

ESAGONO



BUSSOLA ESAGONALE PER DADI RUOTE PER VEICOLI AMERICANI E INGLESÌ

Koken
articolo

DESCRIZIONE

14300A-13/16

13/16"

14300A-7/8

7/8"

14300A-15/16

15/16"

CARATTERISTICHE

- attacco 1/2"
- impronta esagonale
- misura in pollici
- per Tesla
- lunghezza 85 mm

POLLICI

JAPAN



1/2"

ESAGONO

Jeep

Koken
articolo

DESCRIZIONE

14300A-11/16

BUSSOLA ESAGONALE PER DADI RUOTE, PER JEEP RENEGADE

CARATTERISTICHE

- attacco 1/2"
- impronta esagonale
- misura in pollici 11/16"
- misura metrica: 17,5 mm
- diametro: 25,7 mm
- per Jeep
- lunghezza 85 mm

POLLICI

PARETI SOTTILI SU TUTTO IL CORPO



1/2"

ESAGONO

Jeep

Koken
articolo

DESCRIZIONE

24300A-11/16

BUSSOLA ESAGONALE PER DADI RUOTE, PER JEEP RENEGADE, PARETI SOTTILI SU TUTTO IL CORPO

CARATTERISTICHE

- attacco 1/2"
- diametro esterno quadro 1/2": 24 mm
- impronta esagonale
- misura in pollici 11/16"
- misura metrica: 17,5 mm
- diametro: 25,0 mm
- per Jeep
- lunghezza 85 mm



1/2" ESAGONO

16,5 - 17,5
18,5 - 19,5 MM

FEFMEC articolo	DESCRIZIONE
FM 165195 P	SET 4 PEZZI BUSSOLE SPECIALI "POWER IMPACT" CON RIVESTIMENTO IN PLASTICA ESAGONALI

CARATTERISTICHE

- ogni bussola una misura
- attacco quadro: 1/2"
- lunghezza: 78 mm
- materiale: acciaio al cromo molibdeno
- ideali per avvitare bulloni cromati delle ruote di autoveicoli con cerchi in lega
- ideali per: Fiat, Jeep, Ford
- comprende le misure:
 - 16,5 mm - FM 1650 P
 - 17,5 mm - FM 1750 P
 - 18,5 mm - FM 1850 P
 - 19,5 mm - FM 1950 P



1/2" ESAGONO

16,5 - 17,5
18,5 - 19,5 MM

BUSSOLE SPECIALI "POWER IMPACT" CON RIVESTIMENTO IN PLASTICA ESAGONALI

FEFMEC articolo	mm	L mm
FM 1650 P	16,5	78
FM 1750 P	17,5	78
FM 1850 P	18,5	78
FM 1950 P	19,5	78

CARATTERISTICHE

- ogni bussola una misura
- attacco quadro: 1/2"
- lunghezza: 78 mm
- materiale: acciaio al cromo molibdeno
- ideali per avvitare bulloni cromati delle ruote di autoveicoli con cerchi in lega
- ideali per: Fiat, Jeep, Ford



1/2" ESAGONO

BUSSOLE SPECIALI "POWER IMPACT" - CON RIVESTIMENTO ESTERNO E PROTEZIONE INTERNA IN MATERIALE PLASTICO IDEALE PER AVVITARE BULLONI CROMATI DELLE RUOTE DI AUTOVEICOLI CON CERCHI IN LEGA

attacco: 1/2"
impronta: ESAGONO

FEFMEC articolo	mm	L mm	
197-17-LP	17	85	1
197-19-LP	19	85	1
197-21-LP	21	85	1
197-22-LP	22	85	1
197 LPS	SET 3 PEZZI 17-19-21 mm		1



1/2" ESAGONO

FEFMEC articolo	DESCRIZIONE
497 LPS	SET 4 PEZZI BUSSOLE RIVESTITE, ATT. 1/2"

CARATTERISTICHE

- lunghezza: 85 mm
- bussole speciali "POWER IMPACT" con rivestimento esterno e protezione interna in materiale plastico
- ideali per avvitare bulloni cromati delle ruote di autoveicoli CON CERCHI IN LEGA
- misure: 17, 19, 21, 22 mm





novità



1/2"



ESAGONO

PRO+

BGS
articolo

DESCRIZIONE

BGS 74254

SET 11 PEZZI, BUSSOLE IMPACT RIVESTITE, ATT. 1/2", 15 - 27 MM + DADI RUOTA SPECIALI

CARATTERISTICHE

- per uso a mano e a macchina
- con scanalatura e foro per spina
- ricoperte in plastica per prevenire danni ai cerchi
- ogni misura un colore
- in cassetta in plastica
- con profili speciali per Hyundai i30, Tucson, Kia, Mercedes Benz e Tesla
- attacco quadro 1/2"
- materiale: acciaio al cromo molibdeno
- comprende bussole ricoperte, att. 1/2":
 - 15 mm
 - 17 mm (BGS 7301)
 - 19 mm (BGS 7302)
 - 21 mm (BGS 7303)
 - 22 mm
 - 23 mm
 - 24 mm
 - 27 mm
 - 7/8", per Tesla (BGS 7319)
 - per Mercedes Benz serie S (BGS 7309)
 - 21 mm, per Hyundai i30, Tucson e Kia (BGS 9371)
- peso 3,7 kg



novità



1/2"



ESAGONO

PRO+

BGS
articolo

DESCRIZIONE

BGS 7311

SET 10 PEZZI BUSSOLE RICOPERTE, ATT. 1/2", 15 - 24 MM & DADI RUOTA SPECIALI

CARATTERISTICHE

- per uso a mano e a macchina
- con scanalatura e foro per spina
- ricoperte in plastica per prevenire danni ai cerchi
- ogni misura un colore
- in cassetta in plastica
- con profili speciali per Hyundai i30, Tucson, Kia, Mercedes Benz e Tesla
- attacco quadro 1/2"
- materiale: acciaio al cromo molibdeno
- comprende bussole ricoperte, att. 1/2":
 - 15 mm
 - 17 mm (BGS 7301)
 - 19 mm (BGS 7302)
 - 21 mm (BGS 7303)
 - 22 mm
 - 23 mm
 - 24 mm
 - 7/8", per Tesla (BGS 7319)
 - per Mercedes Benz serie S (BGS 7309)
 - 21 mm, per Hyundai i30, Tucson e Kia (BGS 9371)
- peso: 3,1 kg



novità



PRO+

1/2"

BGS
articolo

DESCRIZIONE

BGS 74297

SET 7 PEZZI, BUSSOLE RIVESTITE 17 - 21 MM E ESTRATTORI, ATTACCO 1/2"

CARATTERISTICHE

- bussole rivestite per uso con avvitatori
- con foro per spina e anello
- copertura in plastica e manicotto in plastica per la protezione dei cerchi in alluminio
- manicotto di plastica: ogni misura un colore
- estrattori a vite con taglienti conici
- per allentare e smontare in modo rapido e semplice i bulloni delle ruote, i dadi delle ruote e i vari bloccaggi dei cerchioni
- materiale: acciaio al cromo molibdeno
- attacco quadro: 1/2"
- comprende:
 - 1 estrattore, att. 1/2", 17 mm (BGS 5266-17)
 - 1 estrattore, att. 1/2", 19 mm (BGS 5266-19)
 - 1 estrattore, att. 1/2", 21 mm (BGS 5266-21)
 - 1 bussola rivestita att. 1/2", 17 mm (BGS 7201)
 - 1 bussola rivestita att. 1/2", 19 mm (BGS 7202)
 - 1 bussola rivestita att. 1/2", 21 mm (BGS 7203)
 - 1 cacciaspine
- peso: 1,3 kg





CROMO **PRO+**

BGS articolo	DESCRIZIONE
BGS 7300	SET 3 PEZZI, BUSSOLE SPECIALI RICOPERTE, 17, 19 E 21 MM, ATT. 1/2"
BGS 7301	17 MM
BGS 7302	19 MM
BGS 7303	21 MM

CARATTERISTICHE

- per uso a mano e a macchina
- ricoperte in plastica per prevenire danni ai cerchi
- con scanalatura e foro per spina
- ogni misura un colore
- lunghezza 85 mm



PRO+

RVESTIMENTO PLASTICA COLORATO PER BUSSOLE

BGS articolo	mm	Colore	
BGS 7304	17	Blue	1
BGS 7305	19	Yellow	1
BGS 7306	21	Red	1



1/2"

ESAGONO

PRO+

CROMO

- BUSSOLA A MACCHINA RIVESTITA IN PLASTICA**
- IDONEE PER UTILIZZO A MANO E A MACCHINA
 - CON COPERTURA IN PLASTICA PER PROTEZIONE DEI CERCHI IN ALLUMINIO
 - CON SCANALATURA E FORO PER SPINA
 - LUNGHEZZA 85 MM

BGS articolo	mm	L mm	
BGS 7207	15	85	1
BGS 7201	17	85	1
BGS 7202	19	85	1
BGS 7203	21	85	1
BGS 7208	22	85	1

BGS 7200 SET 3 PEZZI 17-19-21 mm 1

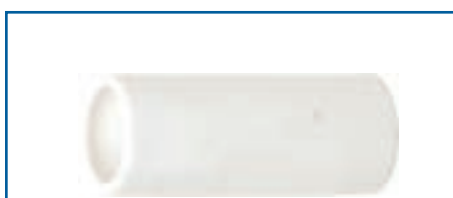

PRO+

RVESTIMENTO PLASTICA PER BUSSOLE

BGS articolo	mm	
BGS 7209	15	1
BGS 7204	17	1
BGS 7205	19	1
BGS 7206	21	1
BGS 7198	22	1



1/2"

CROMO

PRO+

ESAGONO

BGS articolo	DESCRIZIONE
BGS 9847	SET 4 PEZZI, BUSSOLA A MACCHINA RIVESTITA IN PLASTICA, ESAGONALI 17-19-21-22MM, ATT. 1/2"

CARATTERISTICHE

- idonee per utilizzo a mano e a macchina
- con scanalatura e foro per spina
- con copertura in plastica per protezione dei cerchi in alluminio
- ogni misura un colore per una più facile identificazione
- lunghezza 85 mm
- misure: 17, 19, 21, 22 mm
- peso: 1,2 kg



EXTRA LUNGHE

1/2"

ESAGONO

SERIE BUSSOLE SPECIALI RIVESTITE EXTRA LUNGHE 130 MM PER CERCHI IN LEGA PROFONDI

attacco: 1/2"

impronta: ESAGONO

articolo	mm	L mm	
1197-17 LP	17	130	1
1197-19 LP	19	130	1
1197-21 LP	21	130	1
1197-22 LP	22	130	1
1197 LPS	SET 3 PEZZI 17-19-21 mm		1



novità



 PRO+ 1/2" ESAGONO

BGS articolo	DESCRIZIONE
BGS 80003	SET 3 PEZZI, BUSSOLE SPECIALI IMPACT, ATT. 1/2", 17 / 19 / 21 MM

CARATTERISTICHE

- per viti e bulloni a testa svasata
- per avvitatori
- con scanalatura e foro per spina
- attacco quadro 1/2"
- finitura: fosfatata
- materiale: acciaio al cromo molibdeno
- comprende: 17 mm - 19 mm - 21 mm
- peso: 850 g

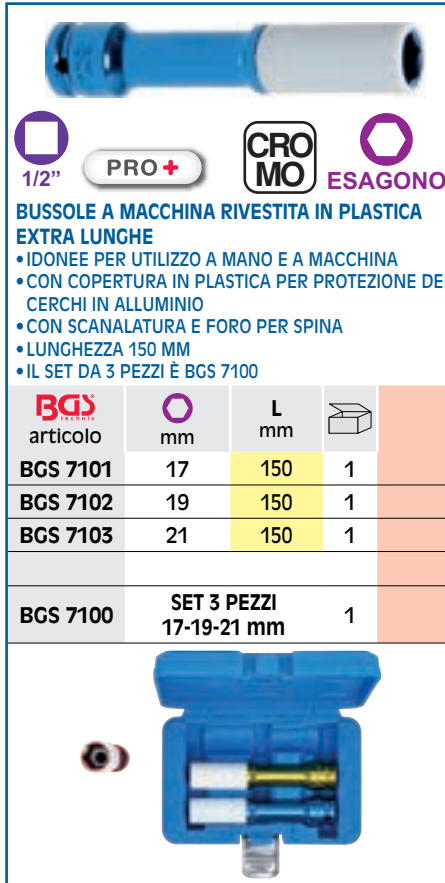

 1/2" PRO+

BUSSOLE A MACCHINA RIVESTITA IN PLASTICA EXTRA LUNGHE

- IDONEE PER UTILIZZO A MANO E A MACCHINA
- CON COPERTURA IN PLASTICA PER PROTEZIONE DEI CERCHI IN ALLUMINIO
- CON SCANALATURA E FORO PER SPINA
- LUNGHEZZA 150 MM
- IL SET DA 3 PEZZI È BGS 7100

BGS articolo	mm	L mm	
BGS 7101	17	150	1
BGS 7102	19	150	1
BGS 7103	21	150	1
BGS 7100	SET 3 PEZZI 17-19-21 mm		1



ESTRATTORE, ATTACCO ESAGONALE

BGS articolo	DESCRIZIONE
BGS 7510-17	17 MM
BGS 7510-19	19 MM
BGS 7510-21	21 MM

CARATTERISTICHE

- per svitare viti, dadi, perni, prigionieri, ecc. danneggiati o arrugginiti
- per uso con bussole impact
- con taglienti a spirale
- attacco esagonale: 17 mm
- materiale: acciaio al cromo molibdeno
- con manicotto protettivo per uso su cerchi in lega

novità



 PRO+ 1/2" ESAGONO

BGS articolo	DESCRIZIONE
BGS 7510	SET 7 PEZZI, ESTRATTORI & BUSSOLE A MACCHINA RIVESTITE, ATT. 1/2", 17/19/21 MM

CARATTERISTICHE

- per allentare e smontare in modo rapido e semplice i bulloni delle ruote, i dadi delle ruote e i vari bloccaggi dei cerchi
- estrattori a vite con taglienti a spirale
- a parete extra sottile per l'utilizzo su cerchi in lega
- estrattori e bussole con copertura in plastica per una perfetta protezione dei cerchi in alluminio
- manicotto di plastica: ogni misura un colore
- attacco quadro: 1/2"
- materiale: acciaio al cromo molibdeno
- comprende:
 - 1 bussola rivestita 17 mm (BGS 7301)
 - 1 bussola rivestita 19 mm (BGS 7302)
 - 1 bussola rivestita 21 mm (BGS 7303)
 - 1 estrattore 17 mm (BGS 7510-17)
 - 1 estrattore 19 mm (BGS 7510-19)
 - 1 estrattore 21 mm (BGS 7510-21)
 - 1 punzone
- peso 1,2 kg

JAPAN



1/2" ESAGONO

Koken articolo P 14145 M/5	DESCRIZIONE Set 5 pezzi + molle di sicurezza
CARATTERISTICHE	
14145PM-110	17, 19, 21, 22
14145PM-110	17MB (PER MERCEDES)
MOLLE	5 PEZZI, C 41

JAPAN

1/2"

PROTEZIONE IN PLASTICA

PLASTICA

110

PROTEZIONE IN PLASTICA

STOP IN PLASTICA

CHIAVI A BUSSOLA, PER BULLONI RUOTE MERCEDES

Mercedes-Benz

Koken articolo	D1 mm	D2 mm	H mm	L mm
14145M-110-17MB	25.7	27.2	11.5	110

CARATTERISTICHE

- per bulloni ruote mercedes
- ad esempio per:
 - Classe S W221
 - Classe M W164, W166
 - Classe CL e GLK X166, X 204
 - Maybach

JAPAN

1/2"

FERMO IN PLASTICA

ESAGONO

CHIAVI A BUSSOLA BOCCA ESAGONALE COLORATE

Koken articolo	mm	D mm	Colore	L mm	
14145PM-17	17	23.7	Blue	110	1
14145PM-19	19	25.7	Red	110	1
14145PM-21	21	27.5	Yellow	110	1
14145PM-22	22	29	White	110	1

JAPAN

1/2"

Koken articolo	DESCRIZIONE
14201 M	Set 3 pezzi
CARATTERISTICHE	
14145PM.110	17, 19, 21





BGS 186 BGS 187
 BGS 185-120 BGS 185-135 BGS 185-150

1/2"

PRO +

BGS articolo	DESCRIZIONE
BGS 185	SET 5 PEZZI, BARRE DI TORSIONE, ATT. 1/2"

CARATTERISTICHE

- 100 - 110 - 120 - 135 - 150 Nm
- lunghezza 195 mm
- peso: 1,6 kg

RICAMBI

BGS articolo	DESCRIZIONE
BGS 186	100 Nm
BGS 187	110 Nm
BGS 185-120	120 Nm
BGS 185-135	135 Nm
BGS 185-150	150 Nm

Non utilizzare le barre di torsione per svitare i dadi, ma solo per avvitare.

Per sicurezza, si consiglia di controllare sempre il serraggio con chiave dinamometrica.

BARRE DI TORSIONE

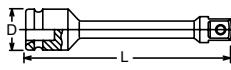

1/2"

BARRE DI TORSIONE CON QUADRO MASCHIO

Koken articolo	Nm	D mm	L mm	
14112-P-90 NM	90	25	208	1
14112-P-95 NM	95	25	202	1
14112-P-100 NM	100	25	196	1
14112-P-110 NM	110	25	213	1
14112-P-120 NM	120	25	201	1
14112-P-130 NM	130	25	203	1
14112-P-140 NM	140	25	205	1
14112-P-150 NM	150	25	205	1
14112-P-170 NM	170	25	195	1

BARRE DI TORSIONE



FAST LEAD

BARRE DI TORSIONE BOCCA FAST LEAD

Koken articolo	mm	Nm	D mm	L mm	
14101M-14 X 95 NM	14	95	208	1	
14101M-15 X 110 NM	15	110	201	1	
14101M-17 X 60 NM	17	60	25	216	1
14101M-17 X 75 NM	17	75	25	228	1
14101M-17 X 95 NM	17	95	25	214	1
14101M-17 X 110 NM	17	110	25	204	1
14101M-17 X 120 NM	17	120	25	203	1
14101M-17 X 140 NM <i>novità</i>	17	140	25	200	1
14101M-19 X 60 NM	19	60	27	219	1
14101M-19 X 90 NM	19	90	27	223	1
14101M-19 X 110 NM	19	110	27	214	1
14101M-19 X 120 NM	19	120	27	203	1
14101M-19 X 135 NM	19	135	27	206	1
14101M-19 X 170 NM	19	170	27	190	1
14101M-21 X 100 NM	21	100	29	214	1
14101M-21 X 120 NM	21	120	29	203	1
14101M-22 X 160 NM	22	160	30	209	1

BARRE DI TORSIONE



BARRE DI TORSIONE COLORATE



FAST LEAD

Koken articolo	mm	Nm	Colore	L mm	
14101MP-17 X 95 NM	17	95	Yellow	214	1
14101MP-17 X 110 NM	17	110	Red	204	1
14101MP-17 X 120 NM	17	120	Green	200	1
14101MP-19 X 90 NM	19	90	Yellow	259	1
14101MP-19 X 100 NM	19	100	Black	233	1
14101MP-19 X 120 NM	19	120	Blue	203	1
14101MP-19 X 140 NM	19	140	Orange	199	1
14101MP-21 X 100 NM	21	100	Black	214	1
14101MP-21 X 120 NM	21	120	Yellow	203	1
14101MP-22 X 150 NM	22	150	Purple	220	1

14101MP/8 ESPOSITORE 8 PEZZI: 17x95 Nm, 17x110 Nm, 17x120 Nm, 19x90 Nm, 19x100 Nm, 19x120 Nm, 19x140 Nm, 21x100 Nm

Non utilizzare le barre di torsione per svitare i dadi, ma solo per avvitare.

Per sicurezza, si consiglia di controllare sempre il serraggio con chiave dinamometrica.

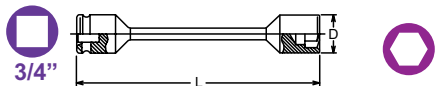
BARRE DI TORSIONE
JAPAN

BARRE DI TORSIONE BOCCA ESAGONALE

Koken articolo	mm	Nm	D mm	L mm	
16101M-24 X 180 NM	24	180	38.8	235	1
16101M-27 X 450 NM	27	450	42.5	280	1
16101M-32 X 600 NM	32	600	48.8	280	1
16101M-33 X 600 NM	33	600	50	280	1

BARRE DI TORSIONE
JAPAN

**BARRE DI TORSIONE
BOCCA
ESAGONALE**

Koken articolo	mm	Nm	D mm	L mm	
18101M-24 X 350 NM	24	350	43.5	300	1
18101M-27 X 350 NM	27	350	47	300	1
18101M-27 X 450 NM	27	450	47	300	1
18101M-29 X 400 NM	29	400	47.8	300	1
18101M-30 X 500 NM	30	500	51	300	1
18101M-32 X 450 NM	32	450	51.5	300	1
18101M-32 X 550 NM	32	550	51.5	300	1
18101M-32 X 600 NM	32	600	51.5	300	1
18101M-32 X 650 NM <small>novità</small>	32	650	51.5	300	1
18101M-32 X 700 NM	32	700	51.5	300	1
18101M-33 X 550 NM	33	550	55	300	1
18101M-33 X 600 NM	33	600	55	300	1
18101M-33 X 650 NM (OZAT)	33	650	58.5	300	1
18101M-36 X 600 NM	36	600	58.5	300	1

BARRE DI TORSIONE, BOCCA ESAGONALE

BGS articolo	mm	Nm	L mm
BGS 6940	24	350	305
BGS 6941	27	350	305
BGS 6942	30	350	305
BGS 6943	32	450	305
BGS 6944	32	500	305
BGS 6945	33	550	305
BGS 6946	33	650	305
BGS 6947	36	600	305

CARATTERISTICHE

- assorbe la coppia eccessiva e la limita alla coppia richiesta
- per l'uso con l'avvitatori ad impulsi
- può essere fissato sull'avvitatore a impulsi con un perno e un O-ring
- DIN 3121
- attacco: quadro femmina 1"
- impronta: esagonale
- lunghezza: 305 mm

NOTE



1/2"



ESAGONO

BUSSOLE "POWER IMPACT"

attacco: 1/2"

impronta: ESAGONO

FEHMEC articolo	mm	D mm	L mm	
197-8	8	15	38	1
197-9	9	16,5	38	1
197-10	10	17,6	38	1
197-11	11	18,9	38	1
197-12	12	20,2	38	1
197-13	13	21,4	38	1
197-14	14	22,7	38	1
197-15	15	23,9	38	1
197-16	16	25	38	1
197-17	17	26,6	38	1
197-18	18	27,9	38	1
197-19	19	29,1	38	1
197-20	20	30,5	38	1
197-21	21	32	38	1
197-22	22	32,9	38	1
197-23	23	35	38	1
197-24	24	35,4	45	1
197-25	25	36	45	1
197-26	26	38	45	1
197-27	27	40	50	1
197-28	28	41	50	1
197-29	29	42	50	1
197-30	30	43	50	1
197-31	31	44	50	1
197-32	32	44	50	1
197-33	33	51	50	1
197-34	34	49	50	1
197-35	35	49	50	1
197-36	36	49	50	1
197-37	37	52	50	1
197-38	38	52	50	1



1/2"



ESAGONO

BUSSOLE "POWER IMPACT"

attacco: 1/2"

impronta: ESAGONO

BGS articolo	mm	L mm	
BGS 5205-8	8	38	1
BGS 5439	9	25	1
BGS 5210	10	38	1
BGS 5211	11	38	1
BGS 5212	12	38	1
BGS 5213	13	38	1
BGS 5214	14	38	1
BGS 5215	15	38	1
BGS 5216	16	38	1
BGS 5217	17	38	1
BGS 5218	18	38	1
BGS 5219	19	38	1
BGS 5221	21	38	1
BGS 5222	22	38	1
BGS 5224	24	45	1
BGS 5227	27	50	1
BGS 5230	30	50	1
BGS 5232	32	50	1
BGS 5205-33	33	50	1
BGS 5205-34	34	50	1
BGS 5205-36	36	50	1
BGS 5205-38	38	50	1
BGS 5233	41	50	1
BGS 70012	52	80	1



ESAGONO

CHIAVI A BUSSOLA A MACCHINA BOCCA ESAGONALE

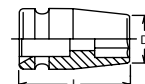

Koken articolo	mm	D mm	L mm	
14400M-8	8	14.5	38	1
14400M-9	9	15.7	38	1
14400M-10	10	17	38	1
14400M-11	11	18.2	38	1
14400M-12	12	19.5	38	1
14400M-13	13	20.7	38	1
14400M-14	14	22	38	1
14400M-15	15	23.2	38	1
14400M-16	16	24.5	38	1
14400M-17	17	25.7	38	1
14400M-18	18	27	38	1
14400M-19	19	28.2	38	1
14400M-20	20	29.5	38	1
14400M-21	21	30.7	38	1
14400M-22	22	32	38	1
14400M-23	23	33.2	38	1
14400M-24	24	34.5	38	1
14400M-25	25	35.7	38	1
14400M-26	26	37	38	1
14400M-27	27	38.2	40	1
14400M-28	28	39.5	40	1
14400M-29	29	40.7	42	1
14400M-30	30	42	42	1
14400M-31	31	43.2	42	1
14400M-32	32	44.5	42	1
14400M-33	33	45.7	46	1
14400M-34	34	47	46	1
14400M-35	35	48.2	46	1
14400M-36	36	49.5	46	1
14400M-38	38	52	46	1
14400M-41	41	55.7	55	1



1/2"



ESAGONO

CASSETTA METALLICA 12 PEZZI

10-11-12-13-14-17-19-22-24-27-30-32 MM

DIMENSIONI CASSETTA: 450 X 130 X 60 MM

attacco: 1/2"

impronta: ESAGONO

FEHMEC articolo	Descrizione	
197112	CASSETTA METALLICA 12 PEZZI	1



1/2"



ESAGONO



PRO+

BGS articolo	DESCRIZIONE
BGS 5205	SET 9 PEZZI, BUSSOLE IMPACT, ATT. 1/2"

CARATTERISTICHE

- misure: 10-12-13-14-15-17-19-21-22-24 mm
- con foro per sfera di bloccaggio
- lunghezza 38 mm
- impact
- esagonali
- peso: 1,1 kg

Koken
articolo

DESCRIZIONE

14242M

Set chiavi a bussola
12 Pezzi
in cassetta metallica
310 x 90 x h 48 mm

RICAMBI

BUSSOLE



ESAGONO

10, 11, 12, 13, 14,
15, 16, 17, 19, 21,
22, 27

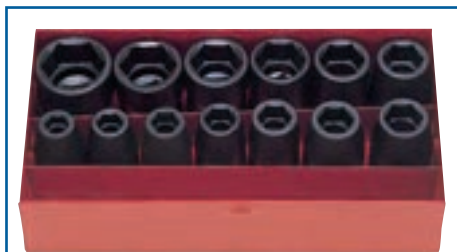

Koken articolo	DESCRIZIONE	
14241M-00	Set chiavi a bussola 13 Pezzi in cassetta metallica 196 x 100 x h 45 mm	
RICAMBI		
BUSSOLE ESAGONO	10, 11, 12, 13, 14, 14400M 15, 16, 17, 19, 21, 22, 24, 27	



BGS articolo	DESCRIZIONE	
BGS 5255	SET 69 PEZZI, BUSSOLE ATT. 1/4" - 1/2"	

CARATTERISTICHE		
<ul style="list-style-type: none"> • in cromo molibdeno • 2 cricchetti reversibili, 1/4" + 1/2", 72 denti, impugnature ergonomiche • bussole da 1/4" esagonali: 4, 4.5, 5, 5.5, 6, 7, 8, 9, 10, 11, 12, 13 e 14 mm • bussole da 1/4", lunghe esagonali: 6, 7, 8, 10, 11, 12 e 13 mm • bussole da 1/2" esagonali: 10, 11, 12, 13, 14, 15, 16, 17, 18, 19, 20, 21, 22, 24, 27, 30 e 32 mm • prolunghe 50 mm e 100 mm, attacco 1/4" • prolunghe 125 mm e 250 mm, attacco 1/2" • adattatore scorrevole per prolunghe da 1/2" • leva c/quadro scorrevole da 1/4", 110 mm • snodi: 1/4", 1/2" • impugnatura 1/4" da 150 mm • chiavi a bussola da 1/4" taglio 4, 5.5 e 7 mm, PH no. 1, 2 e 3, Pz no. 1, 2 e 3; esagono 3, 4, 5, 6, 7 e 8 mm Torx TX10, TX15, TX20, TX25, TX30, TX40 • peso: 6,2 kg 		

EXTRA-CORTE

JAPAN

1/2" ESAGONO

CHIAVI A BUSSOLA A MACCHINA BOCCA ESAGONALE NANO IMPACT EXTRA CORTE

Koken articolo	mm	D mm	L mm		
14401MS-10	10	15.5	23.0	1	
14401MS-12	12	18.0	24.0	1	
14401MS-13	13	19.2	25.0	1	
14401MS-14	14	20.5	25.0	1	
14401MS-15	15	21.7	26.0	1	
14401MS-16	16	23	26.0	1	
14401MS-17	17	24.2	26.0	1	
14401MS-18	18	25.5	26.0	1	
14401MS-19	19	26.7	28.0	1	
14401MS-21	21	29.2	28.5	1	
14401MS-22	22	30.5	28.5	1	
14401MS-24	24	33.0	28.5	1	
14401MS-27	27	36.7	28.5	1	

EXTRA-CORTE

JAPAN

1/2" ESAGONO

RS 14401MS/10

SERIE 10 PEZZI, CHIAVI A BUSSOLA ESAGONALI NANO IMPACT

BUSSOLE ESAGONO	14401MS	10, 12, 13, 14, 17, 19, 21, 22, 24, 27 MM
---------------------------	---------	---

EXTRA-CORTE

CROMO **PRO+** 1/2"

BGS
articolo

DESCRIZIONE

BGS 9551 SET 9 PEZZI, BUSSOLE ESAGONALI IMPACT, EXTRA-CORTE, 13-24 MM

CARATTERISTICHE		
<ul style="list-style-type: none"> • per uso manuale e con avvitatori a percussione • con scanalatura e foro per spina • extra-corte, lunghezza: 28 mm • bussole esagonali • attacco quadro: 1/2" • misure: 13 - 14 - 15 - 16 - 17 - 18 - 19 - 21 - 24 mm • su guida • peso: 660 g 		

EXTRA-CORTE

CROMO **PRO+** 1/2" ESAGONO

BGS
articolo

DESCRIZIONE

BGS 9286 SET 17 PEZZI, BUSSOLE ESAGONALI IMPACT, EXTRA-CORTE, ATT. 1/2"

CARATTERISTICHE		
<ul style="list-style-type: none"> • misure: 8 - 9 - 10 - 11 - 12 - 13 - 14 - 15 - 16 - 17 - 18 - 19 - 20 - 21 - 22 - 23 - 24 mm • extra-corte, lunghezza: 28 mm • esagonali • peso: 1,4 kg 		

PARETI SOTTILI

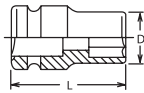

CHIAVI A BUSSOLA
A MACCHINA
BOCCA ESAGONALE
PARETI SOTTILI

Koken articolo	mm	D mm	L mm	
14401M-8	8	13	38	1
14401M-9	9	14.2	38	1
14401M-10	10	15.5	38	1
14401M-11	11	16.7	38	1
14401M-12	12	18	38	1
14401M-13	13	19.2	38	1
14401M-14	14	20.5	38	1
14401M-15	15	21.7	38	1
14401M-16	16	23	38	1
14401M-17	17	24.2	38	1
14401M-18	18	25.5	38	1
14401M-19	19	26.7	38	1
14401M-20	20	28	38	1
14401M-21	21	29.2	38	1
14401M-22	22	30.5	38	1
14401M-23	23	31.7	38	1
14401M-24	24	33	38	1
14401M-25	25	34.2	38	1
14401M-26	26	35.5	38	1
14401M-27	27	36.7	40	1
14401M-28	28	38	40	1
14401M-29	29	39.2	42	1
14401M-30	30	40.5	42	1
14401M-31	31	41.7	42	1
14401M-32	32	43	42	1
14401M-33	33	44.2	46	1
14401M-34	34	45.5	46	1
14401M-35	35	46.7	46	1
14401M-36	36	48	46	1
14401M-38	38	50.5	53	1
14401M-41	41	54.2	55	1

JAPAN

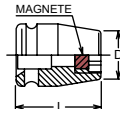

CHIAVI A BUSSOLA
A MACCHINA
BOCCA ESAGONALE
CON MAGNETE

Koken articolo	mm	D mm	L mm	
14400MG-8	8	14.5	38	1
14400MG-10	10	17	38	1
14400MG-12	12	19.5	38	1
14400MG-13	13	20.7	38	1
14400MG-14	14	22	38	1
14400MG-15	15	23.2	38	1
14400MG-16	16	24.5	38	1
14400MG-17	17	25.7	38	1
14400MG-18	18	27	38	1
14400MG-19	19	28.2	38	1
14400MG-21	21	30.7	38	1
FEHMEC				
articolo				
197-22 M	22		38	1
197-24 M	24		38	1



JAPAN

POLLICI

novità



PRO+

BG
articolo

DESCRIZIONE

BG 74296

SET 10 PEZZI,
BUSSOLE IMPACT,
ESAGONALI, ATT. 1/2",
IN POLLICI,
3/8 - 15/16"

CARATTERISTICHE

- misure in pollici
- per uso a macchina
- con scanalatura e foro per spina
- in valigetta
- impronta: esagonale
- attacco: 1/2"
- materiale: acciaio al cromo molibdeno
- finitura: fosfatata
- lunghezza: 38 mm
- comprende:
 - bussole impact esagonali, attacco 1/2":
3/8", 7/16", 1/2", 9/16", 5/8", 11/16", 3/4", 13/16",
7/8", 15/16"
- peso 1,2 kg

POLLICI

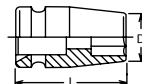

CHIAVI A BUSSOLA
A MACCHINA
BOCCA ESAGONALE

Koken articolo	pollici	D mm	L mm	
14400A-1/4	1/4"	12	38	1
14400A-5/16	5/16"	14.5	38	1
14400A-3/8	3/8"	17	38	1
14400A-7/16	7/16"	18.2	38	1
14400A-1/2	1/2"	20.7	38	1
14400A-9/16	9/16"	22	38	1
14400A-19/32	19/32"	23.2	38	1
14400A-5/8	5/8"	24.5	38	1
14400A-11/16	11/16"	25.7	38	1
14400A-3/4	3/4"	28.2	38	1
14400A-13/16	13/16"	30.7	38	1
14400A-7/8	7/8"	32	38	1
14400A-15/16	15/16"	34.5	38	1
14400A-1	1"	35.7	38	1
14400A-1-1/16	1-1/16"	38.2	40	1
14400A-1-1/8	1-1/8"	40.7	42	1
14400A-1-3/16	1-3/16"	42	42	1
14400A-1-1/4	1-1/4"	44.5	42	1
14400A-1-5/16	1-5/16"	45.7	46	1
14400A-1-3/8	1-3/8"	47	46	1
14400A-1-1/2	1-1/2"	52	46	1

JAPAN

CON
RIVESTIMENTO
ANTI-GRAFFIO

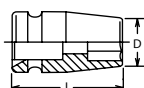

CHIAVI A BUSSOLA
A MACCHINA
BOCCA ESAGONALE
CON RIVESTIMENTO

Koken articolo	mm	D mm	L mm	
14400M-10FR	10	19.5	38	1
14400M-12FR	12	22	38	1
14400M-13FR	13	23.2	38	1
14400M-14FR	14	24.8	38	1
14400M-16FR	16	27	38	1
14400M-17FR	17	28.2	38	1
14400M-19FR	19	31	38	1

JAPAN



**CHIAVI A BUSSOLA
A MACCHINA
BOCCA POLIGONALE**

Kokon articolo	mm	D mm	L mm	
14405M-8	8	14.5	38	1
14405M-9	9	15.7	38	1
14405M-10	10	17	38	1
14405M-11	11	18.2	38	1
14405M-12	12	19.5	38	1
14405M-13	13	20.7	38	1
14405M-14	14	22	38	1
14405M-15	15	23.2	38	1
14405M-16	16	24.5	38	1
14405M-17	17	25.7	38	1
14405M-18	18	27	38	1
14405M-19	19	28.2	38	1
14405M-20	20	29.5	38	1
14405M-21	21	30.7	38	1
14405M-22	22	32	38	1
14405M-23	23	33.2	38	1
14405M-24	24	34.5	38	1
14405M-26	26	37	38	1
14405M-27	27	38.2	40	1
14405M-28	28	39.5	40	1
14405M-30	30	42	42	1
14405M-32	32	44.5	42	1
14405M-36	36	49.5	46	1
14405M-41	41	55.7	55	1



Kokon articolo	DESCRIZIONE
14245M-05	Set 18 Pezzi in cassetta metallica 395 x 90 x h 50 mm
RICAMBI	
BUSSOLE POLIGONALE	14405M 10, 12, 13, 14, 16, 17, 18, 19, 21, 22, 24, 27
	14760-125P
ACCESSORI	14770-P A41, A42 B41, B42



**CHIAVI A BUSSOLA
A MACCHINA
BOCCA POLIGONALE**

Kokon articolo	pollici	D mm	L mm	
14406A-1/4	1/4"	10.5	38	1
14405A-5/16	5/16"	14.5	38	1
14405A-3/8	3/8"	17	38	1
14405A-7/16	7/16"	18.2	38	1
14405A-1/2	1/2"	20.7	38	1
14405A-9/16	9/16"	22	38	1
14405A-5/8	5/8"	24.5	38	1
14405A-11/16	11/16"	25.7	38	1
14405A-3/4	3/4"	28.2	38	1
14405A-13/16	13/16"	30.7	38	1
14405A-7/8	7/8"	32	38	1
14405A-15/16	15/16"	34.5	38	1
14405A-1	1"	35.7	38	1
14405A-1-1/16	1" 1/16	38.2	40	1
14405A-1-1/8	1" 1/8	40.7	42	1
14405A-1-3/16	1" 3/16	42	42	1
14405A-1-1/4	1" 1/4	44.5	42	1
14405A-1-5/16	1" 5/16	45.7	46	1
14405A-1-3/8	1" 3/8	47	46	1
14405A-1-1/2	1" 1/2	52	53	1

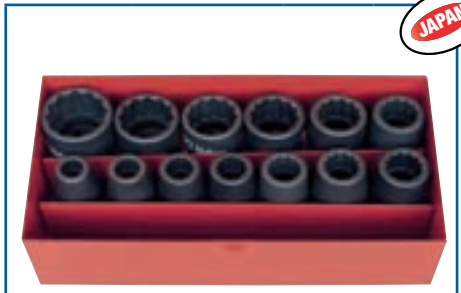

Kokon articolo	DESCRIZIONE
14241M-05	Set chiavi a bussola 13 Pezzi in cassetta metallica 196 x 100 x h 45 mm
RICAMBI	
BUSSOLE POLIGONALE	14405M 10, 11, 12, 13, 14, 15, 16, 17, 19, 21, 22, 24, 27



**CHIAVI A BUSSOLA
A MACCHINA
BOCCA POLIGONALE
PARETI SOTTILI**

Kokon articolo	mm	D mm	L mm	
14406M-8	8	13	38	1
14406M-9	9	14.2	38	1
14406M-10	10	15.5	38	1
14406M-11	11	16.7	38	1
14406M-12	12	18	38	1
14406M-13	13	19.2	38	1
14406M-14	14	20.5	38	1
14406M-15	15	21.7	38	1
14406M-16	16	23	38	1
14406M-17	17	24.2	38	1
14406M-18	18	25.5	38	1
14406M-19	19	26.7	38	1
14406M-20	20	28	38	1
14406M-21	21	29.2	38	1
14406M-22	22	30.5	38	1
14406M-23	23	31.7	38	1
14406M-24	24	33	38	1
14406M-25	25	34.2	38	1
14406M-26	26	35.5	38	1
14406M-27	27	36.7	40	1
14406M-28	28	38	40	1
14406M-29	29	39.2	42	1
14406M-30	30	40.5	42	1
14406M-31	31	41.7	42	1
14406M-32	32	43	42	1
14406M-33	33	44.2	46	1
14406M-34	34	45.5	46	1
14406M-36	36	48	46	1

BUSSOLE SURFACE DRIVE

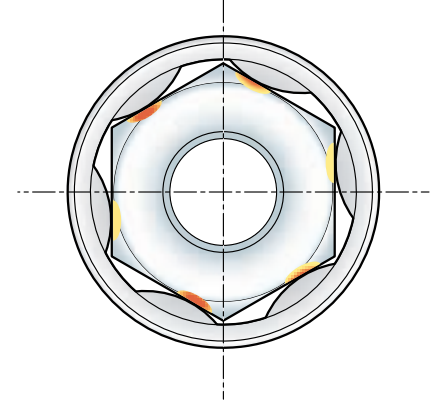

IMPACT 1/2"



**FAST
LEAD**

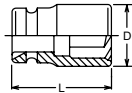

CHIAVI A BUSSOLA
A MACCHINA
BOCCA FAST LEAD

Koken articolo	mm	D mm	L mm	
14465M-10	10	17	38	1
14465M-11	11	18.2	38	1
14465M-12	12	19.5	38	1
14465M-13	13	20.7	38	1
14465M-14	14	22	38	1
14465M-15	15	23.2	38	1
14465M-16	16	24.5	38	1
14465M-17	17	25.7	38	1
14465M-18	18	27	38	1
14465M-19	19	28.2	38	1
14465M-20	20	29.5	38	1
14465M-21	21	30.7	38	1
14465M-22	22	32	38	1
14465M-23	23	33.2	38	1
14465M-24	24	34.5	38	1
14465M-26	26	37	38	1
14465M-27	27	38.2	40	1

JAPAN



TORX®

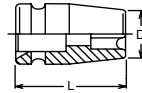

CHIAVI A BUSSOLA
A MACCHINA
BOCCA TORX®

Koken articolo		D mm	L mm	
14425-E10	E 10	14.2	38	1
14425-E11	E 11	14.2	38	1
14425-E12	E 12	15.2	38	1
14425-E14	E 14	18.2	38	1
14425-E16	E 16	19.2	38	1
14425-E18	E 18	22.2	38	1
14425-E20	E 20	24.2	38	1
14425-E22	E 22	26.2	40	1
14425-E24	E 24	28.2	40	1

JAPAN



1/2"

PRO+

CRO
MO

TORX®

CHIAVI A BUSSOLA TORX FEMMINA
ATTACCO 1/2"

BGS articolo		L mm	
BGS 9779-10	E 10	38	1
BGS 9779-12	E 12	38	1
BGS 9779-14	E 14	38	1
BGS 9779-16	E 16	38	1
BGS 9779-18	E 18	38	1
BGS 9779-20	E 20	38	1
BGS 9779-22	E 22	40	1
BGS 9779-24	E 24	40	1

CARATTERISTICHE

- idonee per utilizzo a mano e a macchina
- con scanalatura e foro per spina



**SURFACE
DRIVE**

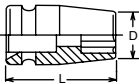

CHIAVI A BUSSOLA
A MACCHINA
BOCCA SURFACE DRIVE

Koken articolo	mm	D mm	L mm	
14410M-10	10	17	38	1
14410M-11	11	18.2	38	1
14410M-12	12	19.5	38	1
14410M-13	13	20.7	38	1
14410M-14	14	22	38	1
14410M-15	15	23.2	38	1
14410M-16	16	24.5	38	1
14410M-17	17	25.7	38	1
14410M-18	18	27	38	1
14410M-19	19	28.2	38	1
14410M-20	20	29.5	38	1
14410M-21	21	30.7	38	1
14410M-22	22	32	38	1
14410M-24	24	34.5	38	1
14410M-25	25	35.7	38	1
14410M-26	26	37	38	1
14410M-27	27	38.2	40	1
14410M-28	28	39.5	40	1
14410M-29	29	40.7	42	1
14410M-30	30	42	42	1
14410M-31	31	43.2	42	1
14410M-32	32	44.5	42	1
14410M-34	34	47	46	1
14410M-36	36	49.5	46	1

JAPAN

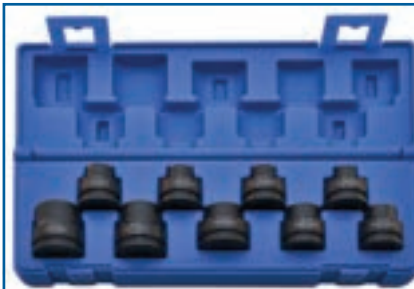

1/2"

TORX®

BUSSOLE IMPACT TORX® FEMMINA
E 10-11-12-14-16-18-20-22-24

attacco: 1/2"
impronta: TX

Descrizione	
articolo 623092	VALIGETTA 9 PEZZI 1



BGS articolo	DESCRIZIONE
BGS 9779	SERIE 8 PEZZI, BUSSOLE IMPACT, TORX FEMMINA, E10-E24, ATT. 1/2"

CARATTERISTICHE

- per uso a mano e macchina
- con foro per bloccaggio con spina e anello
- comprende:
E10 - E12 - E14 - E16 - E18 - E20 - E22 - E24
- attacco quadro femmina 1/2"
- su guida
- peso: 810 g

TORX®	S mm	S mm	
E 4	3.70	E 16	14.60
E 5	4.60	E 18	16.50
E 6	5.60	E 20	18.30
E 7	6.10	E 22	20.10
E 8	7.40	E 24	22.00
E 10	9.30	E 26	23.70
E 11	9.90	E 28	25.50
E 12	11.00	E 30	27.30
E 14	12.80	E 32	29.00

JAPAN



TORXplus

CHIAVI A BUSSOLA A MACCHINA BOCCA TORX PLUS

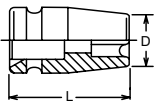

Koken articolo	D mm	L mm	
14425-10EPL	10EPL	14.5	38
14425-12EPL	12EPL	17	38
14425-14EPL	14EPL	18.2	38
14425-16EPL	16EPL	20.7	38
14425-18EPL	18EPL	22	38
14425-20EPL	20EPL	24.5	38



FERMEC FM15TPE

1/4" 3/8" 1/2" TORXplus

articolo	DESCRIZIONE
FM 15 TPE	SET 15 PEZZI, BUSSOLE TORX PLUS, IMPACT ATT. 1/4" - 3/8" - 1/2", 6 EPL - 32 EPL

CARATTERISTICHE

- impact
- impronta Torx Plus
- comprende:
 - attacco 1/4", lunghezza 25 mm: 6 EPL - 7 EPL - 8 EPL
 - attacco 3/8", lunghezza 37 mm: 10 EPL - 12 EPL - 14 EPL - 16 EPL
 - attacco 1/2", lunghezza 45 mm: 18 EPL - 20 EPL - 22 EPL - 24 EPL - 26 EPL - 28 EPL - 30 EPL - 32 EPL

JAPAN



QUADRO

QUADRE FEMMINA
attacco: 1/2"
impronta: QUADRA

articolo	mm	L mm	
197- 7 VKT	7	40	1
197- 8 VKT	8	40	1
197-10 VKT	10	40	1
197-11 VKT	11	40	1
197-12 VKT	12	40	1
197-13 VKT	13	40	1
197-14 VKT	14	40	1
197-15 VKT	15	40	1
197-16 VKT	16	40	1
197-17 VKT	17	40	1
197-18 VKT	18	38	1
197-19 VKT	19	40	1
197-21 VKT	21	40	1
197-22 VKT	22	40	1
197-24 VKT	24	40	1
197-27 VKT	27	46	1
197-30 VKT	30	50	1
197-32 VKT	32	50	1
197-36 VKT	36	55	1

JAPAN



QUADRO

CHIAVI A BUSSOLA A MACCHINA BOCCA QUADRA



articolo	mm	D mm	L mm	
14400WN-8	8	18.3	38	1
14400WN-9	9	19.5	38	1
14400WN-10	10	20.8	38	1
14400WN-12	12	24.5	38	1
14400WN-14	14	27	38	1
14400WN-17	17	32	40	1

JAPAN



OTTAGONALE OTTO ANGOLI

CHIAVI A BUSSOLA A MACCHINA BOCCA OTTAGONALE



articolo	mm	D mm	L mm	
14415M-14	14	25.7	38	1
14415M-15	15	27	38	1
14415M-16	16	29.5	38	1
14415M-17	17	30.7	38	1
14415M-18	18	32	38	1
14415M-19	19	33.2	38	1
14415M-22	22	38.2	40	1
14415M-24	24	42	42	1
14415M-27	27	45.7	46	1
14415M-28	28	47	46	1
14415M-29	29	49.5	46	1



BGS

DESCRIZIONE

BGS 9336 SET 3 PEZZI, BUSSOLE PER RIBE

CARATTERISTICHE

- misure: M6S, M8S, M12S
- finitura fosfata nera
- bussole speciali per: Nissan, Renault, giunti, testate, ecc...
- attacco quadro: 1/2"
- peso: 190 g

TORX PLUS®	S mm	S mm	
E 4	3.70	E 16	14.60
E 5	4.60	E 18	16.50
E 6	5.60	E 20	18.30
E 7	6.10	E 22	20.10
E 8	7.40	E 24	22.00
E 10	9.30	E 26	23.70
E 11	9.90	E 28	25.50
E 12	11.00	E 30	27.30
E 14	12.80	E 32	29.00





BGS articolo	DESCRIZIONE
BGS 2560	SERIE 10 PEZZI, BUSSOLE SPECIALI PER AUTOMOTIVE DA 3-5-6-10 LATI, ATT. 1/2"

CARATTERISTICHE

- contenuto:
 - M10S, per vite centrale tendicinghia
 - M6S, per frizione Nissan e Renault
 - M8S, per testa cilindri e contralbero Nissan
 - M12S, per testa cilindri Nissan
 - 8TS, per contralbero Nissan
 - 10 mm, per impianti di frenatura
 - 12 mm, per pompa del combustibile Nissan
 - 14 mm, per GM e Smart
 - 19 mm, per freno di stazionamento Peugeot, Renault e Citroen
 - 20 mm, per braccio trasversale inferiore Honda Civic
- lunghezza: 38 mm
- peso: 740 g

PARETI SOTTILI SU TUTTO IL CORPO



ESAGONO

CHIAVI A BUSSOLA POWER BOCCA ESAGONALE



Koken articolo	mm	D mm	L mm	
24400M-10	10	15.3	37	1
24400M-11	11	16.5	37	1
24400M-12	12	17.8	37	1
24400M-13	13	19	37	1
24400M-14	14	20.3	37	1
24400M-15	15	21.5	37	1
24400M-16	16	22.8	37	1
24400M-17	17	24	37	1
24400M-18	18	25	37	1
24400M-19	19	26.5	38	1
24400M-20	20	27.8	38	1
24400M-21	21	29	38	1
24400M-22	22	30	40	1
24400M-23	23	31.5	40	1
24400M-24	24	32.8	42	1
24400M-26	26	35	42	1
24400M-27	27	36.5	43	1
24400M-29	29	39	43	1
24400M-30	30	40	46	1
24400M-32	32	42.8	46	1

JAPAN

NOTE

PARETI SOTTILI SU TUTTO IL CORPO



TORX®

CHIAVI A BUSSOLA POWER BOCCA TORX®

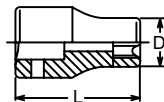

Koken articolo		D mm	L mm	
24425-E10	E 10	14.2	38	1
24425-E12	E 12	15.2	38	1
24425-E14	E 14	18.2	38	1
24425-E16	E 16	19.2	38	1
24425-E18	E 18	22.2	38	1
24425-E20	E 20	24.2	38	1

PARETI SOTTILI SU TUTTO IL CORPO



SURFACE DRIVE

CHIAVI A BUSSOLA POWER BOCCA SURFACE DRIVE

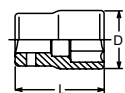

Koken articolo	mm	D mm	L mm	
24410M-10	10	15.3	37	1
24410M-12	12	17.8	37	1
24410M-13	13	19	37	1
24410M-14	14	20.3	37	1
24410M-15	15	21.5	37	1
24410M-16	16	22.8	37	1
24410M-17	17	24.1	37	1
24410M-18	18	25.1	37	1
24410M-19	19	26.6	38	1
24410M-21	21	29.1	30	1
24410M-22	22	30.1	40	1
24410M-24	24	32.9	42	1

JAPAN

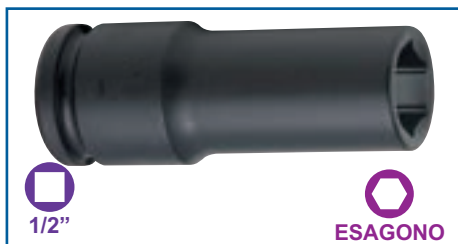

1/2"

ESAGONO

LUNGHE

attacco: 1/2"
impronta: ESAGONO

articolo	mm	D mm	L mm	
197-8 L	8	15	78	1
197-10 L	10	17,6	78	1
197-11 L	11	19	78	1
197-12 L	12	20	78	1
197-13 L	13	21,4	78	1
197-14 L	14	22,7	78	1
197-15 L	15	23,9	78	1
197-16 L	16	25,5	78	1
197-17 L	17	26,6	78	1
197-18 L	18	28	78	1
197-19 L	19	29,1	78	1
197-20 L	20	30	78	1
197-21 L	21	31	78	1
197-22 L	22	32,9	78	1
197-23 L	23	35	78	1
197-24 L	24	35,4	78	1
197-25 L	25	36	78	1
197-26 L	26	38	78	1
197-27 L	27	39,3	78	1
197-28 L	28	39,3	78	1
197-29 L	29	43,5	78	1
197-30 L	30	43,5	78	1
197-32 L	32	48	78	1
197-33 L	33	50	78	1
197-34 L	34	50	78	1
197-36 L	36	54	78	1
197-38 L	38	55	78	1

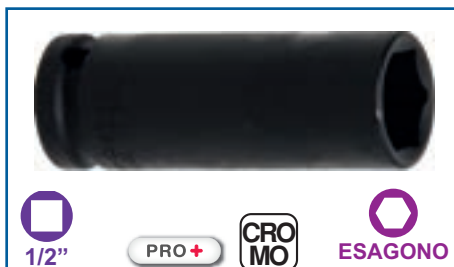

1/2"

PRO+

CROMO

ESAGONO

LUNGHE

attacco: 1/2"
impronta: ESAGONO

articolo	mm	L mm	
BGS 7248	8	78	1
BGS 7210	10	78	1
BGS 7211	11	78	1
BGS 7212	12	78	1
BGS 7213	13	78	1
BGS 7214	14	78	1
BGS 7215	15	78	1
BGS 7216	16	78	1
BGS 7217	17	78	1
BGS 7218	18	78	1
BGS 7219	19	78	1
BGS 7221	21	78	1
BGS 7222	22	78	1
BGS 7224	24	78	1
BGS 7227	27	78	1
BGS 7230	30	78	1
BGS 7232	32	78	1
BGS 7236	36	78	1



ESAGONO

CHIAVI A BUSSOLA
A MACCHINA
BOCCA ESAGONALE
TIPO LUNGO

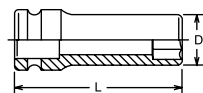

articolo	mm	D mm	L mm	
14300M-8	8	14.5	80	1
14300M-9	9	15.7	80	1
14300M-10	10	17	80	1
14300M-11	11	18.2	80	1
14300M-12	12	19.5	80	1
14300M-13	13	20.7	80	1
14300M-14	14	22	80	1
14300M-15	15	23.2	80	1
14300M-16	16	24.5	80	1
14300M-17	17	25.7	80	1
14300M-18	18	27	80	1
14300M-19	19	28.2	80	1
14300M-20	20	29.5	80	1
14300M-21	21	30.7	80	1
14300M-22	22	32	85	1
14300M-23	23	33.2	85	1
14300M-24	24	34.5	85	1
14300M-25	25	35.7	85	1
14300M-26	26	37	85	1
14300M-27	27	38.2	85	1
14300M-28	28	39.5	85	1
14300M-29	29	40.7	85	1
14300M-30	30	42	85	1
14300M-31	31	43.2	85	1
14300M-32	32	44.5	85	1
14300M-33	33	45.7	85	1
14300M-34	34	47	85	1
14300M-35	35	48.2	85	1
14300M-36	36	49.5	85	1
14300M-38	38	52	85	1
14300M-41	41	55.7	85	1



Kokon
articolo

DESCRIZIONE

14208M

Set 13 Pezzi
in cassetta metallica
395 x 90 x h 50 mm

RICAMBI

BUSSOLE

14300M

10, 12, 13, 14, 15,
16, 17, 18, 19, 21,
22, 24, 27 MM

ESAGONO



Kokon
articolo

DESCRIZIONE

14207M

Set 10 Pezzi
in cassetta metallica
310 x 90 x h 48 mm

RICAMBI

BUSSOLE

14300M

10, 12, 13, 14, 17,
19, 21, 22, 24, 27

ESAGONO



JAPAN

ESAGONO

CON RIVESTIMENTO ANTI-GRAFFIO

CHIAVI A BUSSOLA
A MACCHINA
BOCCA ESAGONALE
TIPO LUNGO
CON RIVESTIMENTO IN
PLASTICA ANTIGRAFFIO

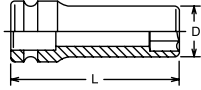

Koken articolo	mm	D mm	L mm	
14300M-10FR	10	19.8	81.3	1
14300M-12FR	12	22.3	81.3	1
14300M-13FR	13	23.5	81.3	1
14300M-14FR	14	24.8	81.3	1
14300M-16FR	16	27.3	81.3	1
14300M-17FR	17	28.5	81.3	1
14300M-19FR	19	31.0	81.3	1



JAPAN

ESAGONO

CHIAVI A BUSSOLA
CON ESAGONO
INTERNO PROFONDO
BOCCA ESAGONALE

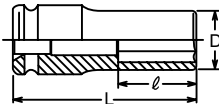

Koken articolo	mm	D mm	l mm	L mm	
14113M-17	17	25.7	34	80	1
14113M-19	19	28.2	38	80	1
14113M-21	21	30.7	42	80	1

5594

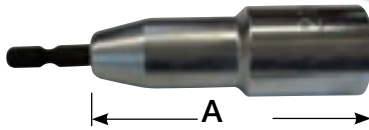
SCARICO
MAGGIORATO

5694



CHIAVI A BUSSOLA ESAGONALI ATT. 1/4"
CON SCARICO INTERNO EXTRA LUNGO

attacco: DIN 3126, E 6,35
impronta: ESAGONO

FEIMEC articolo	mm	scarico "A" mm	L mm	
5594 - 8	8	60	110	5
5594 - 10	10	60	110	5
5594 - 12	12	60	110	5
5594 - 13	13	60	110	5
5594 - 14	14	60	110	5
5594 - 17	17	60	110	5
5594 - 19	19	60	110	5
5594 - 21	21	60	110	5
5594 - 24	24	60	110	5
8594 - 8 <i>novità</i>	8	125	180	5
8594 - 10 <i>novità</i>	10	125	180	5
8594 - 12 <i>novità</i>	12	125	180	5
8594 - 13 <i>novità</i>	13	125	180	5
8594 - 14 <i>novità</i>	14	125	180	5
8594 - 17 <i>novità</i>	17	125	180	5
8594 - 19 <i>novità</i>	19	125	180	5

PARETI SOTTILI

SEMI-LUNGA



JAPAN

ESAGONO

CHIAVI A BUSSOLA
A MACCHINA
BOCCA ESAGONALE
TIPO SEMI-LUNGO
PARETI SOTTILI

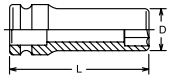

Koken articolo	mm	D mm	L mm	
14301X-8	8	13	60	1
14301X-9	9	14.2	60	1
14301X-10	10	15.5	60	1
14301X-11	11	16.7	60	1
14301X-12	12	18	60	1
14301X-13	13	19.2	60	1
14301X-14	14	20.5	60	1
14301X-15	15	21.7	60	1
14301X-16	16	23	60	1
14301X-17	17	24.2	60	1
14301X-18	18	25.5	60	1
14301X-19	19	26.7	60	1
14301X-21	21	29.2	60	1
14301X-22	22	30.5	65	1
14301X-23	23	31.7	65	1
14301X-24	24	33	65	1
14301X-25	25	34.2	65	1
14301X-26	26	35.5	65	1
14301X-27	27	36.7	65	1
14301X-30	30	40.5	65	1
14301X-32	32	43	65	1
14301X-33	33	44.2	65	1
14301X-34	34	45.5	65	1
14301X-36	36	48	65	1



VUOTE

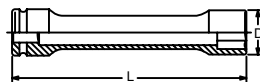

CHIAVI A BUSSOLA EXTRA LUNGHE VUOTE

FEIMEC articolo	mm	DIAMETRO INTERNO MM	L mm	
197-19L-250	19	13	250	1
197-21L-250	21	15	250	1
197-24L-250	24	17	250	1
197-27L-250	27	19	250	1
197-30L-250	30	21	250	1
197-32L-250	32	23	250	1
197-33L-250	33	23	250	1
197-36L-250	36	25	250	1
197-38L-250	38	25	250	1

PARETI SOTTILI

JAPAN



ESAGONO

CHIAVI A BUSSOLA
A MACCHINA
BOCCA ESAGONALE
TIPO LUNGO
PARETI SOTTILI

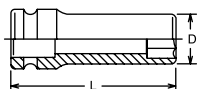

Koken articolo	mm	D mm	L mm	
14301M-8	8	13	80	1
14301M-9	9	14.2	80	1
14301M-10	10	15.5	80	1
14301M-11	11	16.7	80	1
14301M-12	12	18	80	1
14301M-13	13	19.2	80	1
14301M-14	14	20.5	80	1
14301M-15	15	21.7	80	1
14301M-16	16	23	80	1
14301M-17	17	24.2	80	1
14301M-18	18	25.5	80	1
14301M-19	19	26.7	80	1
14301M-20	20	28	80	1
14301M-21	21	29.2	80	1
14301M-22	22	30.5	85	1
14301M-23	23	31.7	85	1
14301M-24	24	33	85	1
14301M-25	25	34.2	85	1
14301M-26	26	35.5	85	1
14301M-27	27	36.7	85	1
14301M-28	28	36.7	85	1
14301M-29	29	38	85	1
14301M-30	30	39.2	85	1
14301M-31	31	41.7	85	1
14301M-32	32	43	85	1
14301M-34	34	45.5	85	1
14301M-35	35	46.7	85	1
14301M-36	36	48	85	1
14301M-38	38	50.5	85	1
14301M-41	41	54.2	85	1



JAPAN



magnete
extra forte

ESAGONO

CHIAVI A BUSSOLA
A MACCHINA
BOCCA ESAGONALE
TIPO LUNGO
MAGNETE RETRATTILE

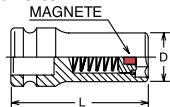

Koken articolo	mm	D mm	L mm	
14300G-10	10	17	80	1
14300G-12	12	19.5	80	1
14300G-13	13	20.7	80	1
14300G-14	14	22	80	1
14300G-15	15	23.2	80	1
14300G-16	16	24.5	80	1
14300G-17	17	25.7	80	1
14300G-18	18	27	80	1
14300G-19	19	28.2	80	1



JAPAN

ESAGONO

CON RIVESTIMENTO ANTI-GRAFFIO

CHIAVI A BUSSOLA
A MACCHINA
BOCCA ESAGONALE
TIPO LUNGO CON
MAGNETE RETRATTILE
CON RIVESTIMENTO IN
PLASTICA ANTIGRAFFIO

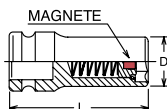

Koken articolo	mm	D mm	L mm	
14300G-10FR	10	19.8	81.3	1
14300G-12FR	12	22.3	81.3	1
14300G-13FR	13	23.5	81.3	1
14300G-14FR	14	24.8	81.3	1
14300G-16FR	16	27.3	81.3	1
14300G-17FR	17	28.5	81.3	1
14300G-19FR	19	31.0	81.3	1



1/2"

ESAGONO



CV

BGS articolo	DESCRIZIONE
BGS 95207	SET 13 PEZZI, BUSSOLE A MACCHINA TIPO LUNGO, ATT. 1/2"

CARATTERISTICHE
<ul style="list-style-type: none"> per uso con avvitatori pneumatici esagonali tipo lungo misure: 10-13-14-15-17-18-19-21-22-24-27-30-32 mm coppia massima: 10 mm - 153 Nm, 13 mm - 249 Nm, 14 mm - 282 Nm, 15 mm - 339 Nm, 17 mm - 475 Nm, 18 mm - 542 Nm, 19 mm - 565 Nm, 21 mm - 570 Nm, 22 mm - 570 Nm, 24 mm - 570 Nm, 27 mm - 570 Nm, 30 mm - 570 Nm, 32 mm - 570 Nm lunghezza totale: 78 mm (profondità utile interna circa 40 mm) peso: 3,6 kg



1/2"

ESAGONO



PRO+

BGS articolo	DESCRIZIONE
BGS 5206	SET 10 PEZZI, BUSSOLE A MACCHINA TIPO LUNGO, ATT. 1/2"

CARATTERISTICHE
<ul style="list-style-type: none"> in cromo molibdeno con scanalatura e foro per spina misure: 10-12-13-14-15-17-19-21-22-24 mm peso: 2,6 kg

IMPACT 1/2"



BGS articolo	DESCRIZIONE
BGS 5207	SET 14 PEZZI, BUSSOLE A MACCHINA TIPO LUNGO, ATT. 1/2"
CARATTERISTICHE	
<ul style="list-style-type: none"> • in cromo molibdeno • 10-12-13-14-15-17-18-19-21-22-24-27-30-32 mm • lunghezza 75 mm • peso: 4,0 kg 	



BGS articolo	DESCRIZIONE
BGS 5335	SET 8 PEZZI, BUSSOLE PER ALBERO MOTORE E MOZZI RUOTE, ATT. 1/2"
CARATTERISTICHE	
<ul style="list-style-type: none"> • bussole poligonali: 27 - 30 - 32 - 34 - 36 mm • bussole esagono maschio: 14 - 17 - 19 mm • peso: 2,0 kg 	



BGS articolo	DESCRIZIONE
BGS 5202	SET 18 PEZZI, BUSSOLE IMPACT E BUSSOLE RIVESTITE, ESAGONALI, ATT. 1/2", 10 - 24 MM
CARATTERISTICHE	
<ul style="list-style-type: none"> • per uso a mano e a macchina • con scanalatura e foro per spina • ricoperte in plastica per prevenire danni ai cerchi • ogni misura un colore • misure metriche • attacco quadro 1/2" • materiale: acciaio al cromo molibdeno • comprende: <ul style="list-style-type: none"> - bussole impact esagonali lunghe, attacco 1/2": <ul style="list-style-type: none"> 10 mm (BGS 7210) - 11 mm (BGS 7211) 12 mm (BGS 7212) - 13 mm (BGS 7213) 14 mm (BGS 7214) - 15 mm (BGS 7215) 16 mm (BGS 7216) - 18 mm (BGS 7218) 20 mm - 22 mm (BGS 7222) 23 mm - 24 mm (BGS 7224) - bussole impact esagonali lunghe, rivestite, attacco 1/2": <ul style="list-style-type: none"> 17 mm (BGS 7201) - 19 mm (BGS 7202) 21 mm (BGS 7203) - prolunghe, att. 1/2": <ul style="list-style-type: none"> 75 mm (BGS 192) - 125 mm (BGS 193) 250 mm (BGS 194) • peso: 4,9 kg 	



BGS articolo	DESCRIZIONE
BGS 5334	SET 6 PEZZI, BUSSOLE PER ALBERO MOTORE E MOZZI RUOTE, ATT. 1/2"
CARATTERISTICHE	
<ul style="list-style-type: none"> • bussole poligonali: 30 - 32 - 36 mm • bussole esagono maschio: 14 - 17 - 19 mm • peso: 2,0 kg 	

POLLICI **JAPAN**



ESAGONO

**CHIAVI A BUSSOLA
A MACCHINA
BOCCA ESAGONALE
TIPO LUNGO**

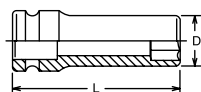

POLLICI **JAPAN**



1/2"



ESAGONO



PRO+



BGS
articolo

DESCRIZIONE

BGS 5208

**SET 13 PEZZI,
BUSSOLE A MACCHINA
TIPO LUNGO, IN
POLLICI,
7/16" - 1 1/4",
ATT. 1/2"**

CARATTERISTICHE

- lunghezza: 75 mm
- fosfatate
- con scanalatura e foro per spina
- misure: 7/16" - 1/2" - 9/16" - 5/8" - 11/16" - 3/4" - 13/16" - 7/8" - 15/16" - 1" - 1" 1/16" - 1" 1/8" - 1" 1/4"
- peso: 4,0 kg

Koken articolo	pollici	D mm	L mm	
14300A-5/16	5/16"	14.5	80	1
14300A-3/8	3/8"	17	80	1
14300A-7/16	7/16"	18.2	80	1
14300A-1/2	1/2"	20.7	80	1
14300A-9/16	9/16"	22	80	1
14300A-5/8	5/8"	24.5	80	1
14300A-11/16	11/16"	25.7	80	1
14300A-3/4	3/4"	28.2	80	1
14300A-13/16	13/16"	30.7	80	1
14300A-7/8	7/8"	32	85	1
14300A-15/16	15/16"	34.5	85	1
14300A-1	1"	35.7	85	1
14300A-1-1/16	1-1/16"	38.2	85	1
14300A-1-1/8	1-1/8"	40.7	85	1
14300A-1-3/16	1-3/16"	42	85	1
14300A-1-1/4	1-1/4"	44.5	85	1
14300A-1-7/16	1-7/16"	50.7	85	1
14300A-1-1/2	1-1/2"	52	85	1

JAPAN

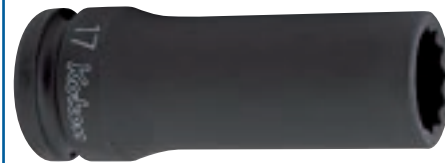

POLIGONALE

**CHIAVI A BUSSOLA
A MACCHINA
BOCCA POLIGONALE
TIPO LUNGO**

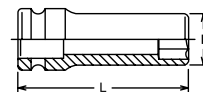

Koken articolo	mm	D mm	L mm	
14305M-8	8	14.5	80	1
14305M-10	10	17	80	1
14305M-11	11	18.2	80	1
14305M-12	12	19.5	80	1
14305M-13	13	20.7	80	1
14305M-14	14	22	80	1
14305M-15	15	23.2	80	1
14305M-16	16	24.5	80	1
14305M-17	17	25.7	80	1
14305M-18	18	27	80	1
14305M-19	19	28.2	80	1
14305M-20	20	29.5	80	1
14305M-21	21	30.7	80	1
14305M-22	22	32	85	1
14305M-23	23	33.2	85	1
14305M-24	24	34.5	85	1
14305M-26	26	37	85	1
14305M-27	27	38.2	85	1
14305M-28	28	39.5	85	1
14305M-29	29	40.7	85	1
14305M-30	30	42	85	1
14305M-32	32	44.5	85	1
14305M-33	33	45.7	85	1
14305M-36	36	49.5	85	1

IMPACT 1/2"





PRO+



POLIGONALE

POLIGONALI LUNGHE

attacco: 1/2"

impronta: POLIGONALE

BGS articolo	mm	L mm	
BGS 5353	21	85	1
BGS 5343	24	85	1
BGS 5336	27	85	1
BGS 5352	28	85	1
BGS 5337	30	85	1
BGS 5338	32	85	1
BGS 5339	33	85	1
BGS 5340	34	85	1
BGS 5341	35	85	1
BGS 5342	36	85	1
BGS 5344	38	85	1
BGS 5351	39	85	1
BGS 5234	46	85	1

PARETI SOTTILI

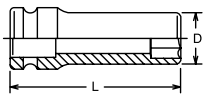

POLIGONALE

**CHIAVI A BUSSOLA
 A MACCHINA
 BOCCA POLIGONALE**
**TIPO LUNGO
 PARETI SOTTILI**

Koken articolo	mm	D mm	L mm	
14306M-8	8	13	80	1
14306M-10	10	15.5	80	1
14306M-11	11	16.7	80	1
14306M-12	12	18	80	1
14306M-13	13	19.2	80	1
14306M-14	14	20.5	80	1
14306M-15	15	21.7	80	1
14306M-16	16	23	80	1
14306M-17	17	24.2	80	1
14306M-18	18	25.5	80	1
14306M-19	19	26.7	80	1
14306M-21	21	29.2	80	1
14306M-22	22	30.5	85	1
14306M-24	24	33	85	1
14306M-26	26	35.5	85	1
14306M-27	27	36.7	85	1
14306M-30	30	40.5	85	1
14306M-32	32	43	85	1



JAPAN

SURFACE DRIVE
**CHIAVI A BUSSOLA
 A MACCHINA
 BOCCA SURFACE
 DRIVE**

TIPO LUNGO

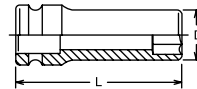

Koken articolo	mm	D mm	L mm	
14310M-10	10	17	80	1
14310M-11	11	18.2	80	1
14310M-12	12	19.5	80	1
14310M-13	13	20.7	80	1
14310M-14	14	22	80	1
14310M-15	15	23.2	80	1
14310M-16	16	24.5	80	1
14310M-17	17	25.7	80	1
14310M-18	18	27	80	1
14310M-19	19	28.2	80	1
14310M-20	20	29.5	80	1
14310M-21	21	30.7	80	1
14310M-22	22	32	85	1
14310M-23	23	33.2	85	1
14310M-24	24	34.5	85	1
14310M-25	25	35.7	85	1
14310M-26	26	37	85	1
14310M-27	27	38.2	85	1
14310M-28	28	39.5	85	1
14310M-29	29	40.7	85	1
14310M-30	30	42	85	1
14310M-31	31	43.2	85	1
14310M-32	32	44.5	85	1
14310M-34	34	47	85	1
14310M-36	36	49.5	85	1

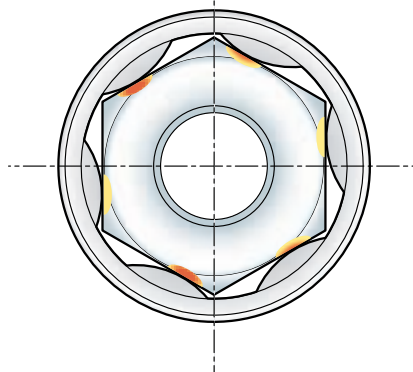
BUSSOLE SURFACE DRIVE
**MULTIMPRONTA
 SPLINE DRIVE**

PRO+



BGS articolo	DESCRIZIONE
BGS 5209	SET 14 PEZZI, BUSSOLE IMPACT MULTIMPRONTA, LUNGHE, 10-32 MM, ATT. 1/2"

CARATTERISTICHE

- comprende le seguenti misure, lunghezza 77 mm: 10 - 12 - 13 - 14 - 15 - 17 - 18 - 19 - 21 - 22 - 24 - 27 - 30 - 32 mm
- scarico interno: 50 mm circa
- adatte per dadi esagonali, poligonali, metriche ed in pollici, TORX®
- peso: 3,2 kg



FAST LEAD

**CHIAVI A BUSSOLA
 A MACCHINA
 BOCCA FAST LEAD**

TIPO LUNGO

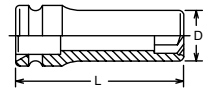

Koken articolo	mm	D mm	L mm	
14365M-10	10	17	80	1
14365M-11	11	18.2	80	1
14365M-12	12	19.5	80	1
14365M-13	13	20.7	80	1
14365M-14	14	22	80	1
14365M-15	15	23.2	80	1
14365M-16	16	24.5	80	1
14365M-17	17	25.7	80	1
14365M-18	18	27	80	1
14365M-19	19	28.2	80	1
14365M-20	20	29.5	80	1
14365M-21	21	30	80	1
14365M-22	22	32	85	1
14365M-23	23	33.2	85	1
14365M-24	24	34.5	85	1
14365M-26	26	37	85	1
14365M-27	27	38.2	85	1



BGS
articolo

DESCRIZIONE

BGS 5204

**SET 10 PEZZI,
BUSSOLE A MACCHINA
TORX,
TIPO LUNGO, ATT. 1/2"**

CARATTERISTICHE

- per uso con avvitatori pneumatici
- in acciaio al cromo-molibdeno
- misure: E10, E11, E12, E14, E16, E18, E20, E22, E24
- con scanalatura e foro per spina
- peso: 1,3 kg



**BUSSOLA A MACCHINA LUNGA
ATTACCO 1/2" TORX**

BGS articolo	+	L mm	
BGS 5204-10	E 10	78	1
BGS 5204-11	E 11	78	1
BGS 5204-12	E 12	78	1
BGS 5204-14	E 14	78	1
BGS 5204-16	E 16	78	1
BGS 5204-18	E 18	78	1
BGS 5204-20	E 20	78	1
BGS 5204-22	E 22	78	1
BGS 5204-24	E 24	78	1

CARATTERISTICHE

- con scanalatura e foro per spina



**CHIAVI A BUSSOLA
A MACCHINA
BOCCA TORX®
TIPO LUNGO**

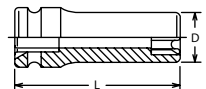

Koken articolo	+	D mm	L mm	
14325-E10	E 10	14.2	80	1
14325-E12	E 12	15.2	80	1
14325-E14	E 14	18.2	80	1
14325-E16	E 16	19.2	80	1
14325-E18	E 18	22.2	80	1
14325-E20	E 20	24.2	80	1

TORX®	S mm	S mm	
E 4	3.70	E 16	14.60
E 5	4.60	E 18	16.50
E 6	5.60	E 20	18.30
E 7	6.10	E 22	20.10
E 8	7.40	E 24	22.00
E 10	9.30	E 26	23.70
E 11	9.90	E 28	25.50
E 12	11.00	E 30	27.30
E 14	12.80	E 32	29.00

JAPAN
PARETI SOTTILI
SU TUTTO IL CORPO



**CHIAVI A BUSSOLA
POWER
BOCCA ESAGONALE
TIPO LUNGO**

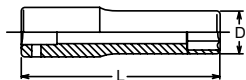

Koken articolo	mm	D mm	L mm	
24300M-10	10	15.3	77	1
24300M-11	11	16.5	77	1
24300M-12	12	17.8	77	1
24300M-13	13	19	77	1
24300M-14	14	20.3	77	1
24300M-15	15	21.5	77	1
24300M-16	16	22.8	77	1
24300M-17	17	24	77	1
24300M-18	18	25	77	1
24300M-19	19	26.5	77	1
24300M-20	20	27.8	77	1
24300M-21	21	29	77	1
24300M-22	22	30	77	1
24300M-24	24	32.8	77	1
24300M-27	27	36.5	77	1
24300M-30	30	40	77	1
24300M-32	32	42.8	77	1

POLLICI



JAPAN
PARETI SOTTILI
SU TUTTO IL CORPO



**CHIAVI A BUSSOLA
POWER BOCCA
ESAGONALE TIPO LUNGO**

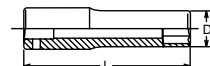

Koken articolo	pollici	D mm	L mm	
24300A-7/16	7/16"	16.5	77	1
24300A-1/2	1/2"	19	77	1
24300A-9/16	9/16"	20.3	77	1
24300A-5/8	5/8"	22.8	77	1
24300A-21/32	21/32"	24	77	1
24300A-11/16	11/16"	25	77	1
24300A-3/4	3/4"	26.5	77	1
24300A-13/16	13/16"	29	77	1
24300A-15/16	15/16"	32.8	77	1



PARETI SOTTILI
SU TUTTO IL CORPO

JAPAN



**SURFACE
DRIVE**

CHIAVI A BUSSOLA
POWER
BOCCA SURFACE
DRIVE TIPO LUNGO

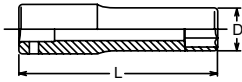

Koken articolo	mm	D mm	L mm		
24310M-10	10	15.3	77	1	
24310M-12	12	17.8	77	1	
24310M-13	13	19	77	1	
24310M-14	14	20.3	77	1	
24310M-15	15	21.5	77	1	
24310M-16	16	22.8	77	1	
24310M-17	17	24.1	77	1	
24310M-18	18	25	77	1	
24310M-19	19	26.5	77	1	
24310M-21	21	29	77	1	
24310M-22	22	30	77	1	
24310M-24	24	32.8	77	1	



JAPAN

CHIAVI A
BUSSOLA
A MACCHINA
BOCCA
ESAGONALE
TIPO EXTRA
LUNGO

ESAGONO

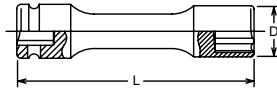

Koken articolo	mm	D mm	L mm		
14145M-100-10	10	17	100	1	
14145M-100-12	12	19.5	100	1	
14145M-100-14	14	22	100	1	
14145M-100-17	17	25.7	100	1	
14145M-100-19	19	28.2	100	1	
14145M-150-10	10	17	150	1	
14145M-150-12	12	19.5	150	1	
14145M-150-13	13	20.7	150	1	
14145M-150-14	14	22	150	1	
14145M-150-15	15	23.2	150	1	
14145M-150-16	16	24.5	150	1	
14145M-150-17	17	25.7	150	1	
14145M-150-18	18	27	150	1	
14145M-150-19	19	28.2	150	1	
14145M-200-10	10	17	200	1	
14145M-200-12	12	19.5	200	1	
14145M-200-13	13	20.7	200	1	
14145M-200-14	14	22	200	1	
14145M-200-15	15	23.2	200	1	
14145M-200-16	16	24.5	200	1	
14145M-200-17	17	25.7	200	1	
14145M-200-18	18	27	200	1	
14145M-200-19	19	28.2	200	1	
14145M-250-10	10	17	250	1	
14145M-250-12	12	19.5	250	1	
14145M-250-13	13	20.7	250	1	
14145M-250-14	14	22	250	1	
14145M-250-15	15	23.2	250	1	
14145M-250-16	16	24.5	250	1	
14145M-250-17	17	25.7	250	1	
14145M-250-18	18	27	250	1	
14145M-250-19	19	28.2	250	1	
14145A-150-9/16	9/16	20	150	1	

POLLICI

JAPAN

novità



CHIAVI A
BUSSOLA
A MACCHINA
CON
MAGNETE
BOCCA
ESAGONALE
TIPO EXTRA
LUNGO

ESAGONO

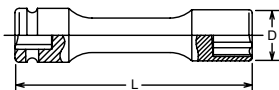

Koken articolo	mm	D mm	L mm		
14145MG-150-10	10	17	150	1	
14145MG-150-12	12	19.5	150	1	
14145MG-150-14	14	22	150	1	
14145MG-150-17	17	25.7	150	1	
14145MG-200-10	10	17	200	1	
14145MG-200-12	12	19.5	200	1	
14145MG-200-14	14	22	200	1	
14145MG-200-17	17	25.7	200	1	



1/2" ESAGONO CROMO PRO+

BGS articolo	DESCRIZIONE
BGS 5200	SET 4 PEZZI, BUSSOLE SNOTATE A MACCHINA, ATT. 1/2"

CARATTERISTICHE

- per utilizzo a macchina
- misure: 16, 17, 18, 19 mm
- attacco quadro da 1/2"
- lunghezza 65 mm
- con scanalatura e foro per spina
- peso: 940 g

RICAMBI

BGS articolo	DESCRIZIONE
BGS 5200-16	16 MM
BGS 5200-17	17 MM
BGS 5200-18	18 MM
BGS 5200-19	19 MM



JAPAN

CHIAVI A BUSSOLA
A MACCHINA
SNOTATE
BOCCA ESAGONALE

ESAGONO

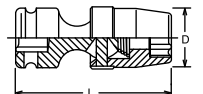

Koken articolo	mm	D mm	L mm		
14440M-13	13	20.7	67.5	1	
14440M-14	14	22	69.5	1	
14440M-15	15	23.2	69.5	1	
14440M-16	16	24.5	69.5	1	
14440M-17	17	25.7	69.5	1	
14440M-18	18	27	69.5	1	
14440M-19	19	28.2	73.5	1	
14440M-20	20	29.5	73.5	1	
14440M-21	21	30.7	73.5	1	
14440M-22	22	32	73.5	1	
14440M-24	24	34.5	75.5	1	
14440A-1/2	1/2"	20.7	67.5	1	
14440A-9/16	9/16"	22	69.5	1	
14440A-5/8	5/8"	24.5	69.5	1	
14440A-11/16	11/16"	25.7	69.5	1	
14440A-3/4	3/4"	28.2	73.5	1	

POLLICI



CHIAVI A
BUSSOLA
A MACCHINA
BOCCA
ESAGONALE
TIPO EXTRA
LUNGO SNODATA

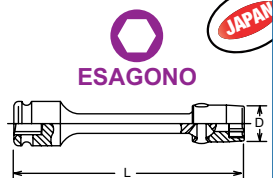

Koken articolo	mm	D mm	L mm	
14146M-150-10	10	16	150	1
14146M-150-12	12	19.3	150	1
14146M-150-13	13	20	150	1
14146M-150-14	14	21	150	1
14146M-150-15	15	22	150	1
14146M-150-16	16	23	150	1
14146M-150-17	17	25	150	1
14146M-150-18	18	28	150	1
14146M-150-19	19	26	150	1
14146M-200-10	10	16	200	1
14146M-200-12	12	19.3	200	1
14146M-200-13	13	20	200	1
14146M-200-14	14	21	200	1
14146M-200-15	15	22	200	1
14146M-200-16	16	23	200	1
14146M-200-17	17	25	200	1
14146M-200-18	18	28	200	1
14146M-200-19	19	26	200	1
14146M-250-10	10	16	250	1
14146M-250-12	12	19.3	250	1
14146M-250-13	13	20	250	1
14146M-250-14	14	21	250	1
14146M-250-15	15	22	250	1
14146M-250-16	16	23	250	1
14146M-250-17	17	25	250	1
14146M-250-18	18	28	250	1
14146M-250-19	19	26	250	1



1/2"



QUADRO

BUSSOLE CON QUADRO MASCHIO

attacco: 1/2"
impronta: QUADRO MASCHIO

FEFMEC articolo	mm	L mm	
4110 M- 6	6	35	1
4110 M- 7	7	35	1
4110 M- 8	8	32	1
4110 M- 10	10	32	1
4110 M- 10,5	10,5	32	1
4110 M- 12	12	32	1
4110 M- 13	13	32	1
4110 M- 13,5	13,5	32	1
4110 M- 14	14	35	1
4110 M- 15	15	35	1
4110 M- 16	16	35	1
4110 M- 19	19	32	1
4110 M- 20	20	32	1

POLLICI



QUADRO

**CHIAVI A BUSSOLA
MASCHIO QUADRO**

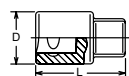

Koken articolo		D mm	L mm	
4110A-3/8	3/8"	24	32	1
4110A-1/2	1/2"	24	32	1



1/2"



ESAGONO



**BUSSOLE ESAGONALI MASCHIO INTEGRALI
CON FORO NEL QUADRO PER SPINA ED
ANELLO**

attacco: 1/2"
impronta: BRUGOLA ESAGONO

FEFMEC articolo	mm	L mm	
BGS 5485-5	5	42	1
BGS 5485-6	6	42	1
BGS 5485-7	7	42	1
BGS 5485-8	8	42	1
BGS 5485-9	9	42	1
BGS 5485-10	10	42	1
BGS 5485-11	11	42	1
BGS 5485-12	12	42	1
BGS 5485-13	13	42	1
BGS 5485-14	14	42	1
BGS 5334-H17	17	42	1
BGS 5334-H19	19	42	1
182 - 1/2" - 4	4	55	1
182 - 1/2" - 5	5	55	1
182 - 1/2" - 6	6	55	1
182 - 1/2" - 7	7	55	1
182 - 1/2" - 8	8	55	1
182 - 1/2" - 10	10	55	1
182 - 1/2" - 12	12	40	1
182 - 1/2" - 13	13	40	1
182 - 1/2" - 14	14	40	1
182 - 1/2" - 16	16	40	1
182 - 1/2" - 17	17	45	1
182 - 1/2" - 19	19	50	1
826004	4	75	1
826005	5	75	1
826006	6	75	1
826008	8	75	1
826010	10	75	1
826012	12	75	1
826014	14	75	1
826017	17	75	1
826019	19	75	1
1182 - 1/2" - 5	5	100	1
1182 - 1/2" - 6	6	100	1
1182 - 1/2" - 8	8	100	1
1182 - 1/2" - 10	10	100	1
1182 - 1/2" - 12	12	100	1
1182 - 1/2" - 14	14	100	1
3182 - 1/2" - 5	5	150	1
3182 - 1/2" - 6	6	150	1
3182 - 1/2" - 8	8	150	1
3182 - 1/2" - 10	10	150	1
3182 - 1/2" - 12	12	150	1
3182 - 1/2" - 14	14	150	1





1/2" **ESAGONO** **PRO+** **CROMO**

BGS articolo	DESCRIZIONE
BGS 5481	SET 8 PEZZI, CHIAVI A BUSSOLA, A MACCHINA, ESAGONALI, ATT. 1/2"

CARATTERISTICHE

- impact
- 5, 6, 8, 10, 12, 14, 17, 19 mm
- lunghezza: 75 mm
- con scanalatura e foro per spina
- peso: 1,3 kg

RICAMBI

BGS articolo	DESCRIZIONE
BGS 5481-M5	5 MM
BGS 5481-M6	6 MM
BGS 5481-M7	7 MM
BGS 5481-M8	8 MM
BGS 5481-M10	10 MM
BGS 5481-M12	12 MM
BGS 5481-M14	14 MM
BGS 5481-M17	17 MM
BGS 5481-M19	19 MM



1/2" **CROMO** **PRO+** **ESAGONO**

BGS articolo	DESCRIZIONE
BGS 5485	SET 9 PEZZI, CHIAVI A BUSSOLA, MASCHIO ESAGONALE, 5-19 MM, ATT. 1/2"

CARATTERISTICHE

- con scanalatura e foro per spina
- misure: 5 - 6 - 7 - 8 - 10 - 12 - 14 - 17 - 19 mm
- lunghezza: 42 mm
- attacco quadro: 1/2"
- peso 930 g

RICAMBI

BGS articolo	DESCRIZIONE
BGS 5485-5	5 MM
BGS 5485-6	6 MM
BGS 5485-7	7 MM
BGS 5485-8	8 MM
BGS 5485-9	9 MM
BGS 5485-10	10 MM
BGS 5485-11	11 MM
BGS 5485-12	12 MM
BGS 5485-13	13 MM
BGS 5485-14	14 MM



ESAGONO

CHIAVI A BUSSOLA A MACCHINA MASCHIO ESAGONALE INTEGRALE

Koken articolo	mm	D mm	l mm	L mm	Box
14012M-60-4	4	25	15.5	60	1
14012M-60-5	5	25	15.5	60	1
14012M-60-6	6	25	15.5	60	1
14012M-60-7	7	25	15.5	60	1
14012M-60-8	8	25	15.5	60	1
14012M-60-10	10	30	15.5	60	1
14012M-60-12	12	30	15.5	60	1
14012M-60-14	14	30	15.5	60	1
14012M-60-16	16	30	15.5	60	1
14012M-60-17	17	30	15.5	60	1
14012M-60-19	19	30	15.5	60	1



ESAGONO

SERIE 10 PZ. CHIAVI A BUSSOLA A MACCHINA MASCHIO ESAGONALE

Koken articolo	mm	Box
RS 14012M/10-L60	4, 5, 6, 7, 8, 10, 12, 14, 17, 19	1



POLLICI



1/2"



ESAGONO

BUSSOLE ESAGONALI MASCHIO INTEGRALI CON FORO NEL QUADRO PER SPINA ED ANELLO - MISURE IN POLLICI

attacco: 1/2"

impronta: BRUGOLA ESAGONO

articolo	pollici	L mm	
182 W-1/2"-1/8"	1/8"	44	1
182 W-1/2"-5/32"	5/32"	44	1
182 W-1/2"-3/16"	3/16"	44	1
182 W-1/2"-7/32"	7/32"	44	1
182 W-1/2"-1/4"	1/4"	44	1
182 W-1/2"-5/16"	5/16"	44	1
182 W-1/2"-3/8"	3/8"	47	1
182 W-1/2"-7/16"	7/16"	50	1
182 W-1/2"-1/2"	1/2"	50	1
182 W-1/2"-9/16"	9/16"	50	1
182 W-1/2"-5/8"	5/8"	50	1
821006	3/16"	75	1
821007	7/32"	75	1
821008	1/4"	75	1
821009	9/32"	75	1
821010	5/16"	75	1
821012	3/8"	75	1
821014	7/16"	75	1
821016	1/2"	75	1
821018	9/16"	75	1
821020	5/8"	75	1

POLLICI



1/2"

SERIE BUSSOLE IMPACT BRUGOLA LUNGH. 75 MM MISURE IN POLLICI: 3/16"-7/32"-1/4"-5/16"-3/8" 7/16"-1/2"-9/16"-5/8"

attacco: 1/2"

impronta: ESAGONO MASCHIO

articolo	Descrizione	
421091	CASSETTA METALLICA 9 PEZZI	1

novità



1/2"

ESAGONO



CHIAVI A BUSSOLA MASCHIO ESAGONALI

Attacco: 1/2"

impronta: ESAGONO

articolo	mm	L mm
FM 355-100-4	4	100
FM 355-100-5	5	100
FM 355-100-6	6	100
FM 355-100-8	8	100
FM 355-100-10	10	100
FM 355-100-12	12	100



novità



1/2"

ESAGONO



BUSSOLE ESAGONALI CON TESTA SFERICA, LUNGHEZZA 75 MM, ATT. 1/2"

articolo	DESCRIZIONE
BGS 5488-6	6 MM
BGS 5488-8	8 MM
BGS 5488-10	10 MM
BGS 5488-12	12 MM
BGS 5488-14	14 MM
BGS 5488-15	15 MM
BGS 5488-17	17 MM
BGS 5488-19	19 MM

CARATTERISTICHE

- per uso manuale e con avvitatore
- con scanalatura e foro per spina
- esagono con testa sferica
- consente di lavorare in sicurezza anche in aree di lavoro difficili
- consente l'avvitamento con un'angolazione fino a 25°.
- attacco quadro femmina 1/2"
- lunghezza: 75 mm

novità



1/2"



ESAGONO



articolo

DESCRIZIONE

BGS 5488

SET 8 PEZZI, BUSSOLE ESAGONALI CON TESTA SFERICA, LUNGHEZZA 75 MM, ATT. 1/2", 6 - 19 MM

CARATTERISTICHE

- per uso manuale e con avvitatore
- con scanalatura e foro per spina
- esagono con testa sferica
- consente di lavorare in sicurezza anche in aree di lavoro difficili
- consente l'avvitamento con un'angolazione fino a 25°.
- attacco quadro femmina 1/2"
- lunghezza: 75 mm
- comprende:
 - BGS 5488-6: esagono 6 mm
 - BGS 5488-8: esagono 8 mm
 - BGS 5488-10: esagono 10 mm
 - BGS 5488-12: esagono 12 mm
 - BGS 5488-14: esagono 14 mm
 - BGS 5488-15: esagono 15 mm
 - BGS 5488-17: esagono 17 mm
 - BGS 5488-19: esagono 19 mm
- peso 1,4 kg

JAPAN



ESAGONO

CHIAVI A BUSSOLA A MACCHINA MASCHIO ESAGONALE TIPO EXTRA LUNGO SNODATA



articolo	mm	D mm	l mm	L mm	
14147M-150-6	6	25	15	150	1
14147M-150-8	8	25	15	150	1
14147M-150-10	10	25	15	150	1
14147M-150-12	12	25	15	150	1
14147M-200-6	6	25	15	200	1
14147M-200-8	8	25	15	200	1
14147M-200-10	10	25	15	200	1
14147M-200-12	12	25	15	200	1



CHIAVI A BUSSOLA
A MACCHINA
MASCHIO TORX®

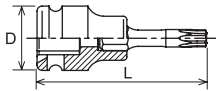

<i>Kokon</i> articolo		L mm	
14025-60-T20	TX 20	60	1
14025-60-T25	TX 25	60	1
14025-60-T27	TX 27	60	1
14025-60-T30	TX 30	60	1
14025-60-T40	TX 40	60	1
14025-60-T45	TX 45	60	1
14025-60-T50	TX 50	60	1
14025-60-T55	TX 55	60	1
14025-60-T60	TX 60	60	1
14025-100-T30	TX 30	100	1
14025-100-T40	TX 40	100	1
14025-100-T45	TX 45	100	1
14025-100-T50	TX 50	100	1
14025-100-T55	TX 55	100	1
14025-100-T60	TX 60	100	1



SERIE 6 PZ. CHIAVI A BUSSOLA A MACCHINA
MASCHIO TORX®

<i>Kokon</i> articolo		
RS 14025/6-L60	TX30, TX40, TX45, TX50, TX55, TX60	1



1/2"



BUSSOLE TORX® IMPACT MASCHIO
INTEGRALI CON FORO NEL QUADRO PER
SPINA ED ANELLO

attacco: 1/2"
impronta: TX

<i>FERMEC</i> articolo		L mm	
BGS 5486-T20	TX 20	42	1
BGS 5486-T25	TX 25	42	1
BGS 5486-T27	TX 27	42	1
BGS 5486-T30	TX 30	42	1
BGS 5486-T40	TX 40	42	1
BGS 5486-T45	TX 45	42	1
BGS 5486-T50	TX 50	42	1
BGS 5486-T55	TX 55	42	1
BGS 5486-T60	TX 60	42	1
BGS 5486-T70	TX 70	42	1
BGS 5486-T80	TX 80	42	1
721025	TX 25	55	1
721027	TX 27	55	1
721030	TX 30	55	1
721040	TX 40	55	1
721045	TX 45	55	1
721047	TX 47	55	1
721050	TX 50	55	1
721055	TX 55	55	1
721060	TX 60	55	1
722020	TX 20	75	1
722025	TX 25	75	1
722027	TX 27	75	1
722030	TX 30	75	1
722040	TX 40	75	1
722045	TX 45	75	1
722050	TX 50	75	1
722055	TX 55	75	1
722060	TX 60	75	1
BGS 5480-T70	TX 70	75	1
BGS 5480-T80	TX 80	75	1



1/2"



BUSSOLE IMPACT TORX® MASCHIO
TX 20-25-27-30-40-45-50-55-60
LUNGH. 75 MM

attacco: 1/2"
impronta: TX

<i>FERMEC</i> articolo	Descrizione	
621091	CASSETTA METALLICA 9 PEZZI	1

TORX®	S mm	S mm	
T 6	1.70	T 40	6.70
T 7	2.00	T 45	7.90
T 8	2.30	T 50	8.90
T 9	2.50	T 55	11.30
T 10	2.70	T 60	13.30
T 15	3.30	T 70	15.60
T 20	3.90	T 80	17.60
T 25	4.50	T 90	20.00
T 27	5.00	T 100	22.20
T 30	5.60		



1/2"

PRO+



BGS articolo

DESCRIZIONE

BGS 5097

**SERIE 10 PEZZI,
BUSSOLE A MACCHINA
TORX® T20 - T70,
ATT. 1/2"**

CARATTERISTICHE

- per l'uso con utensili pneumatici
- comprende i seguenti formati: T20 - T25 - T27 - T30 - T40 - T45 - T50 - T55 - T60 - T70
- lunghezza 53 mm
- attacco quadro femmina 1/2"
- attacco quadro: 1/2"
- peso: 960 g

RICAMBI

BGS articolo	DESCRIZIONE
BGS 5369	TX 20
BGS 5370	TX 25
BGS 5367	TX 27
BGS 5371	TX 30
BGS 5372	TX 40
BGS 5373	TX 45
BGS 5374	TX 50
BGS 5375	TX 55



1/2"



PRO+

CRO MO

BGS articolo

DESCRIZIONE

BGS 5480

**SET 9 PEZZI,
CHIAVI A BUSSOLA
A MACCHINA TORX,
TX20-TX70,
LUNGH. 75 MM,
ATT. 1/2"**

CARATTERISTICHE

- per utilizzo a macchina
- misure: TX20 - TX25 - TX30 - TX40 - TX45 - TX50 - TX55 - TX60 - TX70
- lunghezza: 75 mm
- con scanalatura e foro per spina
- peso: 1,1 kg

RICAMBI

BGS articolo	DESCRIZIONE
BGS 5480-T20	TX 20
BGS 5480-T25	TX 25
BGS 5480-T30	TX 30
BGS 5480-T40	TX 40
BGS 5480-T45	TX 45
BGS 5480-T50	TX 50
BGS 5480-T55	TX 55
BGS 5480-T60	TX 60
BGS 5480-T70	TX 70
BGS 5480-T80	TX 80



1/2"

CRO MO

PRO+



BGS articolo

DESCRIZIONE

BGS 5486

**SET 9 PEZZI,
CHIAVI A BUSSOLA
A MACCHINA TORX,
TX20-TX70,
LUNGH. 42 MM,
ATT. 1/2"**

CARATTERISTICHE

- con scanalatura e foro per spina
- misure: TX20 - TX25 - TX30 - TX40 - TX45 - TX50 - TX55 - TX60 - TX70
- lunghezza: 42 mm
- attacco quadro: 1/2"
- peso: 830 g

RICAMBI

BGS articolo	DESCRIZIONE
BGS 5486-T20	TX 20
BGS 5486-T25	TX 25
BGS 5486-T27	TX 27
BGS 5486-T30	TX 30
BGS 5486-T40	TX 40
BGS 5486-T45	TX 45
BGS 5486-T50	TX 50
BGS 5486-T55	TX 50
BGS 5486-T60	TX 60
BGS 5486-T70	TX 70
BGS 5486-T80	TX 80



IMPACT 1/2"





 1/2"

 XZN

**BUSSOLE XZN IMPACT MASCHIO INTEGRALI
 CON FORO NEL QUADRO PER SPINA ED
 ANELLO**

 attacco: 1/2"
 impronta: XZN

BGS articolo		L mm	
BGS 5381-M12	M 12	40	1
BGS 5381-M14	M 14	40	1
BGS 5381-M16	M 16	40	1
BGS 5381-M18	M 18	40	1
BGS 5487-M4	M 4	42	1
BGS 5487-M5	M 5	42	1
BGS 5487-M6	M 6	42	1
BGS 5487-M8	M 8	42	1
BGS 5487-M10	M 10	42	1
BGS 5482-M4	M 4	75	1
BGS 5482-M5	M 5	75	1
BGS 5482-M6	M 6	75	1
BGS 5482-M8	M 8	75	1
BGS 5482-M9	M 9	75	1
BGS 5482-M10	M 10	75	1
BGS 5482-M12	M 12	75	1
BGS 5482-M14	M 14	75	1
BGS 5482-M16	M 16	75	1
BGS 5184-M18	M 18	78	1





 1/2"

 XZN

**BUSSOLE XZN IMPACT MASCHIO
 CON FORO NEL QUADRO PER SPINA ED
 ANELLO**

 attacco: 1/2"
 impronta: XZN

BGS articolo		L mm	
BGS 4463	M 12	140	1



 1/2"

 XZN

PRO+

 CROMO

 BGS
articolo

DESCRIZIONE

BGS 5482

**SET 9 PEZZI,
 CHIAVI A BUSSOLA A
 MACCHINA XZN,
 ATT. 1/2"**
CARATTERISTICHE

- per utilizzo a macchina
- M4-5-6-8-9-10-12-14-16
- lunghezza: 75 mm
- con scanalatura e foro per spina
- peso: 1,1 kg

RICAMBI

BGS articolo	DESCRIZIONE
BGS 5482-M4	M 4
BGS 5482-M5	M 5
BGS 5482-M6	M 6
BGS 5482-M8	M 8
BGS 5482-M9	M 9
BGS 5482-M10	M 10
BGS 5482-M12	M 12
BGS 5482-M14	M 14
BGS 5482-M16	M 16



 1/2"

PRO+

 CROMO

 XZN

 BGS
articolo

DESCRIZIONE

BGS 5381

**SET 8 PEZZI,
 CHIAVI A BUSSOLA A
 MACCHINA XZN, ATT.
 1/2"**
CARATTERISTICHE

- misure: M12, M14, M16, M18
- per ogni misura una bussola lunghezza 40 mm e una lunghezza 75 mm
- peso: 1,1 kg

RICAMBI

BGS articolo	DESCRIZIONE
BGS 5381-M12	M12, LUNGH. 40 MM
BGS 5381-M14	M14, LUNGH. 40 MM
BGS 5381-M16	M16, LUNGH. 40 MM
BGS 5381-M18	M18, LUNGH. 40 MM
BGS 5184-M18	M18, LUNGH. 78 MM





BGS articolo	DESCRIZIONE
BGS 5380	SET 6 PEZZI, CHIAVI A BUSSOLA A MACCHINA XZN, ATT. 1/2"

CARATTERISTICHE

- comprende:
 - XZN, lunghezza 40 mm : M 14 - 16 - 18
 - XZN, lunghezza 75 mm : M 14 - 16 - 18
- applicazioni ad esempio: pinza freno VW Touareg (asse posteriore), MB Atego
- per uso con avvitatori pneumatici
- peso: 890 g

RICAMBI

BGS articolo	DESCRIZIONE
BGS 5381-M14	M14, LUNGH. 40 MM
BGS 5381-M16	M16, LUNGH. 40 MM
BGS 5381-M18	M18, LUNGH. 40 MM
BGS 5482-M14	M14, LUNGH. 75 MM
BGS 5482-M16	M16, LUNGH. 75 MM
BGS 5184-M18	M18, LUNGH. 78 MM

XZN	S mm	S mm
M 4	3,60	M12 11,50
M 5	4,80	M14 13,30
M 6	6,10	M16 15,70
M 8	7,30	M18 16,90
M10	9,70	



BGS articolo	DESCRIZIONE
BGS 5487	SET 9 PEZZI, CHIAVI A BUSSOLA A MACCHINA XZN, M4-M16, ATT. 1/2"

CARATTERISTICHE

- con scanalatura e foro per spina
- misure: M4 - M5 - M6 - M8 - M9 - M10 - M12 - M14 - M16
- lunghezza: 42 mm
- attacco quadro: 1/2"
- peso: 840 g

RICAMBI

BGS articolo	DESCRIZIONE
BGS 5487-M4	M 4
BGS 5487-M5	M 5
BGS 5487-M6	M 6
BGS 5487-M8	M 8
BGS 5487-M10	M 10
BGS 5381-M12	M 12
BGS 5381-M14	M 14
BGS 5381-M16	M 16



BGS articolo	DESCRIZIONE
BGS 5484	SET 26 PEZZI, CHIAVI A BUSSOLA A MACCHINA, TORX / XZN/ESAGONO, ATT. 1/2"

CARATTERISTICHE

- 9 chiavi a bussola Torx maschio: TX25-TX30-TX40-TX45-TX50-TX55-TX60-TX70-TX80
- 8 chiavi a bussola esagono maschio: 5-6-8-10-12-14-17-19 mm
- 9 chiavi a bussola XZN: M5-M6-M8-M9-M10-M12-M14-M16-M18
- lunghezza: 75 mm
- peso 4,5 kg



BGS articolo	DESCRIZIONE
BGS 5483	SET 9 PEZZI, CHIAVI A BUSSOLA A MACCHINA RIBE, ATT. 1/2"

CARATTERISTICHE

- per utilizzo a macchina
- 5, 6, 7, 8, 9, 10, 12, 13, 14 mm
- lunghezza: 75 mm
- con scanalatura e foro per spina
- peso: 1,1 kg

RICAMBI

BGS articolo	DESCRIZIONE
BGS 5483-M5	M 5
BGS 5483-M6	M 6
BGS 5483-M7	M 7
BGS 5483-M8	M 8
BGS 5483-M9	M 9
BGS 5483-M10	M 10
BGS 5483-M12	M 12
BGS 5483-M13	M 13
BGS 5483-M14	M 14

13134-SC

BUSSOLA PORTA INSERTI CON GRANO DI BLOCCAGGIO DA 7/16"

Koken
articolo

D mm	L mm	
25	38	1

RICAMBI

Koken articolo	DESCRIZIONE
13134-SC	GRANO DI RICAMBIO M8X5; ESAGONO 4 MM

7/16" ESAGONO

INSERTO CON MASCHIO ESAGONALE

attacco: 7/16"
impronta: ESAGONO

Koken
articolo

mm	L mm	
183H-35-3	35	1
183H-35-4	35	1
183H-35-5	35	1
183H-35-6	35	1
183H-35-7	35	1
183H-35-8	35	1
183H-35-9	35	1
183H-35-10	35	1
183H-35-11	35	1
183H-35-12	35	1
183H-35-14	35	1
183H-35-16	35	1
183H-35-17	35	1
183H-35-18	35	1
183H-35-19	35	1
183H-75-3	75	1
183H-75-4	75	1
183H-75-5	75	1
183H-75-6	75	1
183H-75-7	75	1
183H-75-8	75	1
183H-75-10	75	1
183H-75-11	75	1
183H-75-12	75	1
183H-75-14	75	1
183H-150-4	150	1
183H-150-5	150	1
183H-150-6	150	1
183H-150-8	150	1
183H-150-10	150	1
183H-150-12	150	1

7/16" ESAGONO

POLLICI

INSERTO CON MASCHIO ESAGONALE

attacco: 7/16"
impronta: ESAGONO

Koken
articolo

POLLICI	L mm	
183H-35-3/16	35	1
183H-35-7/32	35	1
183H-35-1/4	35	1
183H-35-5/16	35	1
183H-35-3/8	35	1
183H-35-7/16	35	1
183H-35-1/2	35	1

14142-F11.2

BUSSOLA PORTA INSERTI CON SGANCIO RAPIDO DA 7/16"

Koken
articolo

D mm	L mm	
25	46	1

1/2" ESAGONO

BUSSOLA MASCHIO ESAGONALE IN DUE PARTI: BUSSOLA + INSERTO MASCHIO ESAGONALE

Koken
articolo

mm	L mm	
14134M-58-3	58	1
14134M-58-4	58	1
14134M-58-5	58	1
14134M-58-6	58	1
14134M-58-7	58	1
14134M-58-8	58	1
14134M-58-10	58	1
14134M-58-12	58	1
14134M-58-14	58	1
14134M-98-3	98	1
14134M-98-4	98	1
14134M-98-5	98	1
14134M-98-6	98	1
14134M-98-7	98	1
14134M-98-8	98	1
14134M-98-10	98	1
14134M-98-12	98	1
14134M-98-14	98	1

IMPACT 1/2"



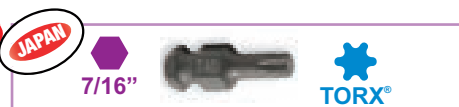

**INSERTO CON MASCHIO ESAGONALE
CON TESTA SFERICA**

INSERTO CON MASCHIO TORX®

BUSSOLA MASCHIO ESAGONALE

IN DUE PARTI:

BUSSOLA + INSERTO MASCHIO TORX®

attacco: 7/16"
impronta: ESAGONO CON TESTA SFERICA

attacco: 7/16"
impronta: TORX®

Koken articolo	mm	L mm	
183H-75-6B	6	75	1
183H-75-8B	8	75	1
183H-75-10B	10	75	1
183H-75-12B	12	75	1
183H-150-6B	6	150	1
183H-150-8B	8	150	1
183H-150-10B	10	150	1
183H-150-12B	12	150	1

Koken articolo	TORX	L mm	
183T-35-T25	TX 25	35	1
183T-35-T30	TX 30	35	1
183T-35-T40	TX 40	35	1
183T-35-T45	TX 45	35	1
183T-35-T50	TX 50	35	1
183T-35-T55	TX 55	35	1
183T-35-T60	TX 60	35	1

Koken articolo	TORX	L mm	
14134T-58-T25	TX 25	58	1
14134T-58-T30	TX 30	58	1
14134T-58-T40	TX 40	58	1
14134T-58-T45	TX 45	58	1
14134T-58-T50	TX 50	58	1
14134T-58-T55	TX 55	58	1
14134T-58-T60	TX 60	58	1
14134T-98-T30	TX 30	98	1
14134T-98-T40	TX 40	98	1
14134T-98-T45	TX 45	98	1
14134T-98-T50	TX 50	98	1
14134T-98-T55	TX 55	98	1
14134T-98-T60	TX 60	98	1



183T-75-T25 <i>novità</i>	TX 25	75	1
183T-75-T27 <i>novità</i>	TX 27	75	1
183T-75-T30	TX 30	75	1
183T-75-T40	TX 40	75	1
183T-75-T45	TX 45	75	1
183T-75-T50	TX 50	75	1
183T-75-T55	TX 55	75	1
183T-75-T60	TX 60	75	1
183T-150-T30	TX 30	150	1
183T-150-T40	TX 40	150	1
183T-150-T45	TX 45	150	1
183T-150-T50	TX 50	150	1
183T-150-T55	TX 55	150	1
183T-150-T60 <i>novità</i>	TX 60	150	1

TORX®	S mm	S mm	
T 6	1.70	T 40	6.70
T 7	2.00	T 45	7.90
T 8	2.30	T 50	8.90
T 9	2.50	T 55	11.30
T 10	2.70	T 60	13.30
T 15	3.30	T 70	15.60
T 20	3.90	T 80	17.60
T 25	4.50	T 90	20.00
T 27	5.00	T 100	22.20
T 30	5.60		

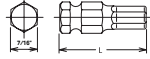
7/16" 



INSERTO CON MASCHIO TORX PLUS®

Kokon articolo		L mm	
183T-35-30IP	30IP	35	1
183T-35-40IP	40IP	35	1
183T-35-45IP	45IP	35	1
183T-35-50IP	50IP	35	1
183T-35-55IP	55IP	35	1
183T-35-60IP	60IP	35	1
183T-75-30IP	30IP	75	1
183T-75-40IP	40IP	75	1
183T-75-45IP	45IP	75	1
183T-75-50IP	50IP	75	1
183T-75-55IP	55IP	75	1
183T-75-60IP	60IP	75	1

JAPAN

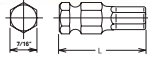

JAPAN

7/16" 



INSERTO CON MASCHIO XZN

attacco: 7/16"
impronta: XZN

Kokon articolo		L mm	
183X-35-M 4	M 4	35	1
183X-35-M 5	M 5	35	1
183X-35-M 6	M 6	35	1
183X-35-M 8	M 8	35	1
183X-35-M 10	M10	35	1
183X-35-M 12	M12	35	1
183X-35-M 14	M14	35	1
183X-75-M 4	M 4	75	1
183X-75-M 5	M 5	75	1
183X-75-M 6	M 6	75	1
183X-75-M 8	M 8	75	1
183X-75-M 10	M10	75	1
183X-75-M 12	M12	75	1
183X-75-M 14	M14	75	1
183X-150-M 5	M 5	150	1
183X-150-M 6	M 6	150	1
183X-150-M 8	M 8	150	1
183X-150-M 10	M10	150	1
183X-150-M 12	M12	150	1
183X-150-M 14 <small>novità</small>	M14	150	1

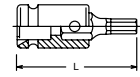

1/2" 



BUSSOLA MASCHIO ESAGONALE

IN DUE PARTI:

BUSSOLA + INSERTO MASCHIO XZN

Kokon articolo		L mm	
14134X-58-M5	M 5	58	1
14134X-58-M6	M 6	58	1
14134X-58-M8	M 8	58	1
14134X-58-M10	M10	58	1
14134X-58-M12	M12	58	1
14134X-58-M14	M14	58	1
14134X-98-M5	M 5	98	1
14134X-98-M6	M 6	98	1
14134X-98-M8	M 8	98	1
14134X-98-M10	M10	98	1
14134X-98-M12	M12	98	1
14134X-98-M14	M14	98	1

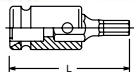

1/2" 



BUSSOLA MASCHIO ESAGONALE

IN DUE PARTI:

BUSSOLA + INSERTO MASCHIO TORX PLUS®

Kokon articolo		L mm	
14134T-58-30IP	30IP	58	1
14134T-58-40IP	40IP	58	1
14134T-58-45IP	45IP	58	1
14134T-58-50IP	50IP	58	1
14134T-58-55IP	55IP	58	1
14134T-58-60IP	60IP	58	1
14134T-98-30IP	30IP	98	1
14134T-98-40IP	40IP	98	1
14134T-98-45IP	45IP	98	1
14134T-98-50IP	50IP	98	1
14134T-98-55IP	55IP	98	1
14134T-98-60IP	60IP	98	1

JAPAN

XZN

S

S

M 4	3,60	M12	11,50
M 5	4,80	M14	13,30
M 6	6,10	M16	15,70
M 8	7,30	M18	16,90
M10	9,70		

TORX PLUS

S

S

8 IP	2.30	30 IP	5.60
9 IP	2.50	40 IP	6.70
10 IP	2.70	45 IP	7.90
15 IP	3.30	50 IP	8.90
20 IP	3.90	55 IP	11.30
25 IP	4.50	60 IP	13.30
27 IP	5.00		





PROLUNGHE PER
BUSSOLE
"POWER IMPACT"
MASCHIO/FEMMINA

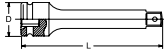

FEARMEC articolo		L mm	
97-6-75	PERNO	75	1
97-7	PERNO	125	1
97-8	PERNO	175	1
97-9	PERNO	250	1
97-6 S	SFERA	50	1
97-6-75 S	SFERA	75	1
97-7 S	SFERA	125	1
97-8 S	SFERA	175	1
97-9 S	SFERA	250	1
97-9-300 S	SFERA	300	1
97-9-460 S	SFERA	460	1
97-9-610 S	SFERA	610	1
97-9-915 S	SFERA	915	1



PROLUNGA

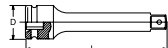

Koken articolo	D mm		L mm	
14760-50P	30	PERNO	50	1
14760-75P	30	PERNO	75	1
14760-100P	30	PERNO	100	1
14760-125P	30	PERNO	125	1
14760-150P	30	PERNO	150	1
14760-175P	30	PERNO	175	1
14760-200P	30	PERNO	200	1
14760-250P	30	PERNO	250	1
14760-300P <i>novità</i>	30	PERNO	300	1
14760-50	30	FORO	50	1
14760-75	30	FORO	75	1
14760-100	30	FORO	100	1
14760-125	30	FORO	125	1
14760-150	30	FORO	150	1
14760-175	30	FORO	175	1
14760-200	30	FORO	200	1
14760-250	30	FORO	250	1
14760-300 <i>novità</i>	30	FORO	300	1



PERNO

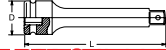

CON RIVESTIMENTO ANTI-GRAFFIO
PROLUNGA CON RIVESTIMENTO

Koken articolo	D mm	L mm	
14760-75P.FR	34.2	75	1
14760-125P.FR	34.2	125	1
14760-250P.FR	34.2	250	1



1/2"

1/2"

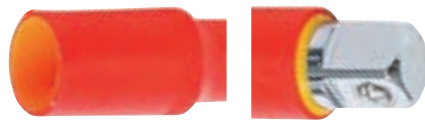

PROLUNGHE ISOLATE VDE, ATT. 1/2"

BGS articolo	F	M	L mm
BGS 72083	1/2"	1/2"	125
BGS 72084	1/2"	1/2"	250

CARATTERISTICHE

- per bussole
- con sfera di tenuta
- per lavorare in sicurezza su componenti sotto tensione
- perfette per l'utilizzo su impianti elettrici o per i lavori di riparazione e manutenzione di veicoli ibridi ed elettrici
- perfette per elettricisti e specialisti del settore elettrico
- isolate VDE fino a 1000 V, secondo EN 60900/IEC 60900
- attacco quadro: 1/2"
- materiale: acciaio al cromo vanadio
- finitura: isolata
- DIN: EN/IEC 60900



novità

BGS articolo	DESCRIZIONE
BGS 25145	SET 9 PEZZI, PROLUNGHE IMPACT, 1/4" - 3/8" - 1/2"

CARATTERISTICHE

- per uso a mano e a macchina
- con scanalatura e foro per spina
- in cassetta in plastica
- materiale: acciaio al cromo molibdeno
- attacco quadro
- finitura: nero brunito
- comprende:
 - prolunghe impact, att. 1/4": 50 mm - 100 mm - 150 mm
 - prolunghe impact, att. 3/8": 50 mm - 75 mm - 150 mm
 - prolunghe impact, att. 1/2": 50 mm - 125 mm (BGS 193) - 250 mm (BGS 194)
- peso 1,6 kg

0

SFERA

1/2" PRO+ CROMO 1/2"

articolo	DESCRIZIONE
BGS 190	SNODO A MACCHINA

CARATTERISTICHE

- finitura nera
- lunghezza: 70 mm
- con sfera di tenuta
- peso: 170 g

1/2" JAPAN 1/2"

PERNO	SFERA	FORO

SNODO UNIVERSALE

articolo	L mm	
14770-P PERNO	74	1
14770-B SFERA	74	1
14770 FORO	74	1

ADATTATORI DOPPIO QUADRO MASCHIO

articolo	L mm
2841	20
3841	30
4841	37
BGS 9623	53
8841	68

CARATTERISTICHE

- con doppia sfera

SFERA

1/4" 3/8" 1/2" PRO+ CROMO

articolo	DESCRIZIONE
BGS 9459	SET 3 PEZZI, SNODI

CARATTERISTICHE

- con scanalatura e foro per spina
- comprende:
 - snodo 1/4" F - 1/4" M
 - snodo 3/8" F - 3/8" M
 - snodo 1/2" F - 1/2" M
- peso: 420 g

1/2" JAPAN 3/4"

PERNO	SFERA

DOPPIO SNODO

articolo	D mm	L mm	
14772-P PERNO	27	90	1
14772-B SFERA	27	90	1

B A FORO

PROLUNGHE PER BUSSOLE "POWER IMPACT" MASCHIO/MASCHIO

articolo	B	A	L mm	
Z 0802	1/2"	1/2"	50	1
Z 0803	1/2"	1/2"	76	1
Z 0805	1/2"	1/2"	127	1
Z 0810	1/2"	1/2"	254	1
Z 1203	3/4"	3/4"	78	1
Z 1204	3/4"	3/4"	101	1
Z 1205	3/4"	3/4"	127	1
Z 1207	3/4"	3/4"	177	1
Z 1603	1"	1"	76	1
Z 1604	1"	1"	101	1
Z 1605	1"	1"	127	1
Z 1606	1"	1"	152	1
Z 1616	1"	1"	406	1
Z 2404	1 1/2"	1 1/2"	101	1
Z 2405	1 1/2"	1 1/2"	127	1
Z 4005	2-1/2"	2-1/2"	127	1

1/2" JAPAN 1/2"

PERNO	SFERA	FORO

SNODO UNIVERSALE

articolo	L mm	
14771-P PERNO	65	1
14771-B SFERA	65	1
14771 FORO	65	1

1/2" JAPAN 3/4"

SGANCIO RAPIDO - Lock & Quick Release

LOCK RELEASE

RACCORDO DI RIDUZIONE QUADRO MASCHIO 3/4" E FEMMINA 1/2" CON SGANCIO RAPIDO PER BUSSOLE "POWER IMPACT"

articolo	L mm	
14466 AL	75	1

B A

RIDUZIONI PER BUSSOLE "POWER IMPACT" FEMMINA/FEMMINA

articolo	B	A	L mm	
AN 0808	1/2"	1/2"	33	1
AN 1208	3/4"	1/2"	49	1
AN 1212	3/4"	3/4"	49	1
AN 1612	1"	3/4"	63	1
AN 1616	1"	1"	59	1
AN 2416	1-1/2"	1"	83	1
AN 2424	1 1/2"	1-1/2"	85	1



RACCORDI DI RIDUZIONE "POWER IMPACT" MASCHIO/FEMMINA

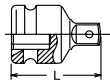

Kokon articolo		F	M	L mm	
12233 A-P	PERNO	1/4"	3/8"	22	1
12233 A-B	SFERA	1/4"	3/8"	22	1
12233 A	FORO	1/4"	3/8"	22	1
⚠ 13322 A-P	PERNO	3/8"	1/4"	27	1
⚠ 13322 A-B	SFERA	3/8"	1/4"	27	1
⚠ 13322 A	FORO	3/8"	1/4"	27	1
13344 A-P	PERNO	3/8"	1/2"	32.5	1
13344 A-B	SFERA	3/8"	1/2"	32.5	1
13344 A	FORO	3/8"	1/2"	32.5	1
⚠ 14433 A-P	PERNO	1/2"	3/8"	37.5	1
⚠ 14433 A-B	SFERA	1/2"	3/8"	37.5	1
⚠ 14433 A	FORO	1/2"	3/8"	37.5	1
14455 A	FORO	1/2"	5/8"	42	1
14466 A	FORO	1/2"	3/4"	44	1
14466 A-B	SFERA	1/2"	3/4"	44	1
14466 A-200 B	SFERA	1/2"	3/4"	200	1
14488 A-B	SFERA	1/2"	1"	58	1
14488 A-200 B	SFERA	1/2"	1"	200	1
⚠ 15544 A-P	PERNO	5/8"	1/2"	46	1
⚠ 15544 A	FORO	5/8"	1/2"	46	1
15566 A	FORO	5/8"	3/4"	48	1
⚠ 16644 A-B	PERNO	3/4"	1/2"	54	1
⚠ 16644 A-P	SFERA	3/4"	1/2"	54	1
⚠ 16644 A	FORO	3/4"	1/2"	54	1
⚠ 16655 A	FORO	3/4"	5/8"	55.5	1
16688 A	FORO	3/4"	1"	62	1
16688 A-250	FORO	3/4"	1"	250	1
16688 A-330	FORO	3/4"	1"	330	1
⚠ 18866 A	FORO	1"	3/4"	66.5	1
⚠ 18866 A-200	FORO	1"	3/4"	200	1
18877 A	FORO	1"	1-1/2"	80	1
⚠ 17788 A	FORO	1-1/2"	1"	98	1
17799 A	FORO	1-1/2"	2-1/2"	115	1
⚠ 19977 A	FORO	2-1/2"	1-1/2"	145	1
⚠ 10099 A	FORO	3-1/2"	2-1/2"	182	1



RACCORDI DI RIDUZIONE "POWER IMPACT" MASCHIO/FEMMINA

FE/MEC articolo		F	M	L mm	
96-00	PERNO	1/4"	3/8"	32	1
⚠ 96-0	PERNO	3/8"	1/4"	35	1
96-1	PERNO	3/8"	1/2"	45	1
⚠ 96-01	PERNO	1/2"	1/4"	38	1
⚠ 96-2	PERNO	1/2"	3/8"	45	1
96-3	FORO	5/8"	1/2"	50	1
⚠ 96-4	PERNO	3/4"	1/2"	56	1
96-8	FORO	3/4"	1"	70	1
⚠ 96-9	FORO	1"	3/4"	70	1
⚠ 96-10	PERNO	1"	1/2"	70	1
96-11	FORO	1/2"	3/4"	50	1
⚠ 96-12	FORO	1 1/2"	1"	115	1
96-13	FORO	1"	1 1/2"	115	1
96-14	FORO	2 1/2"	1 1/2"	115	1
⚠ 96-15	FORO	1 1/2"	2 1/2"	120	1
⚠ 96-16	FORO	1 1/4"	1"	140	1
96-17	FORO	1 3/4"	1 1/2"	150	1



RACCORDI DI RIDUZIONE "POWER IMPACT" MASCHIO/FEMMINA CON SFERA DI TENUTA NEL QUADRO MASCHIO

FE/MEC articolo		F	M	L mm	
696-00 S		1/4"	3/8"	26	1
⚠ 696-0 S		3/8"	1/4"	32	1
⚠ 696-01 S		1/2"	1/4"	36	1
696-1 S		3/8"	1/2"	36	1
⚠ 696-2 S		1/2"	3/8"	38	1
696-11 S		1/2"	3/4"	48	1
⚠ 696-4 S		3/4"	1/2"	56	1
696-8 S		3/4"	1"	63	1
⚠ 696-9 S		1"	3/4"	75	1



ARTICOLO NON SOGGETTO A GARANZIA



PRO+ CROMO

BGS articolo	DESCRIZIONE
BGS 200	SET 6 PEZZI, RIDUZIONI A MACCHINA

CARATTERISTICHE

- rivestimento specifico nero opaco
- peso: 880 g

CONTENUTO

- 1/4" F X 3/8" M, coppia massima 60 Nm
- 3/8" F X 1/4" M, coppia massima 60 Nm
- 3/8" F X 1/2" M, coppia massima 200 Nm
- 1/2" F X 3/8" M, coppia massima 200 Nm
- 1/2" F X 3/4" M, coppia massima 500 Nm
- 3/4" F X 1/2" M, coppia massima 500 Nm



PRO+ CROMO

BGS articolo	DESCRIZIONE
BGS 25140	SET 11 PEZZI, RIDUZIONI E SNODI A MACCHINA

CARATTERISTICHE

- rivestimento specifico nero opaco
- peso: 2,6 kg

CONTENUTO

- 1/4" F x 3/8" M
- 3/8" F x 1/4" M
- 3/8" F x 1/2" M
- 1/2" F x 3/8" M
- 1/2" F x 3/4" M
- 3/4" F x 1/2" M
- 3/4" F x 1" M
- 1" F x 3/4" M
- snodi da 1/4", 3/8", 1/2"



RACCORDI DI RIDUZIONE CHROM-VANADIUM

attacco: 1/4" - 3/8" - 1/2" - 3/4"

BGS articolo	FEMMINA	MASCHIO	L mm	1
BGS 271	1/4"	3/8"	1	1
BGS 269	3/8"	1/4"	1	1
BGS 280	3/8"	1/2"	1	1
BGS 270	1/2"	3/8"	1	1
BGS 272	1/2"	3/4"	1	1
BGS 274	3/4"	1/2"	1	1



RACCORDI DI RIDUZIONE A MANDRINO CON SGANCIO RAPIDO "POWER IMPACT"

FE# articolo	F	M	L mm	1
691-0 SWF	3/8"	1/4"	55	1
691-1 SWF	3/8"	1/2"	60	1
691-2 SWF	1/2"	3/8"	55	1
691-11 SWF	1/2"	3/4"	75	1
691-4 SWF	3/4"	1/2"	70	1
691-9 SWF	1"	3/4"	90	1

Koken

14466 AL	1/2"	3/4"	75	1
16644 AL	3/4"	1/2"	70	1



RACCORDI DI RIDUZIONE MAGNETICI "POWER IMPACT" A SCOMPARSA - SPAZI RIDOTTI

FE# articolo	F	M	L mm	1
698-00	1/4"	3/8"	17	1
698-0	1/4"	1/2"	22	1
698-1	3/8"	1/2"	22	1
698-11	1/2"	3/4"	30	1
698-8	3/4"	1"	35	1
698-13	1"	1 1/2"	50	1
698-15	1 1/2"	2 1/2"	60	1

698 CASSETTA 4 PZ. CONTENUTO: 1 PZ. 698-00, 1 PZ. 698-1, 1 PZ. 698-11, 1 PZ. 698-8



RACCORDO DI RIDUZIONE MASCHIO/FEMMINA CON SFERA DI TENUTA NEL QUADRO MASCHIO

attacco: 1/4"-3/8"-1/2"

Koken articolo	F	M	L mm	1
2233 A	1/4"	3/8"	22	1
3322 A	3/8"	1/4"	24	1
3344 A	3/8"	1/2"	35	1
4433 A-35	1/2"	3/8"	35	1
4433 A-75	1/2"	3/8"	75	1
4433 A-125	1/2"	3/8"	125	1
4433 A-250	1/2"	3/8"	250	1
4433 A-600	1/2"	3/8"	600	1
4466 A	1/2"	3/4"	42	1
6644 A	3/4"	1/2"	47	1
6688 A	3/4"	1"	60	1
8866 A	1"	3/4"	60	1



RACCORDI DI RIDUZIONE MAGNETICI A SCOMPARSA IDEALI PER CHIAVI DINAMOMETRICHE E SPAZI RIDOTTI

attacco: 1/4"-3/8"-1/2"

FE# articolo	F	M	L mm	1
1434-1/4	1/4"	3/8"	1	1
1434-3/8	3/8"	1/2"	1	1
1434-1/2	1/2"	3/4"	1	1

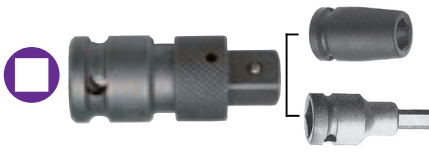

MANDRINO CON SGANCIO RAPIDO PER BUSSOLE "POWER IMPACT"

attacco: Quadro femmina
impronta: DIN 3126, E 11,2 - E 6,35

FE# articolo	F	M	L mm	1
195-SWF	1/4"	1/4"	41	1
196-SWF	3/8"	3/8"	46	1
97-3-125 SWF	3/8"	3/8"	125	1
197-SWF	1/2"	1/2"	60	1
199-SWF	3/4"	3/4"	78	1
1991-SWF	1"	1"	100	1

Koken

12222 AL	1/4"	1/4"	35	1
13333 AL	3/8"	3/8"	45	1
14444 AL	1/2"	1/2"	55	1
16666 AL	3/4"	3/4"	75	1
18888 AL	1"	1"	95	1



RIDUZIONI A SCOMPARSA CON SFERA NEL QUADRO MASCHIO

Koken articolo	F	M	D mm	L mm	1
2756 Z-3/8	1/4"	3/8"	20.3	21.5	1
2756 Z-1/2	1/4"	1/2"	20.3	26	1
3756 Z-1/2	3/8"	1/2"	28	29	1

10 MOLLE-SPINE-ANELLI

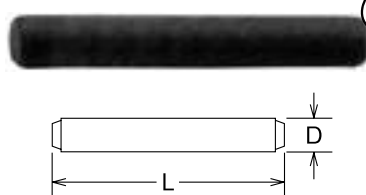

SPINE ACCIAIO PER BUSSOLE

Kokoen articolo	Ø	D mm	L mm	
A 21	1/4"	1.5	10,2	1
A 31	3/8"	2.5	14,5	1
A 32	3/8"	2.5	17,5	1
A 41	1/2"	3.0	20	1
A 42	1/2"	3.0	25	1
A 51	5/8"	4.0	29	1
A 61	3/4"	4.0	35	1
A 62	3/4"	4.0	45	1
A 81	1"	5.0	45	1
A 82	1"	5.0	57	1
A 83	1"	5.0	75	1
A 71	1 1/2"	6.0	75	1
A 72	1 1/2"	6.0	110	1
A 91	2 1/2"	8.0	110	1
A 92	2 1/2"	8.0	155	1
A 01	3 1/2"	13.0	155	1
A 02	3 1/2"	13.0	180	1

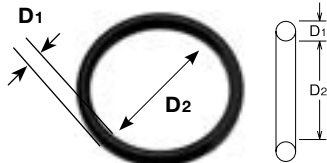

ANELLI DI GOMMA PER BUSSOLE

Kokoen articolo	Ø	D 1 mm	D 2 mm	
B 21	1/4"	2.5	9	1
B 31	3/8"	3.5	13	1
B 32	3/8"	3.5	16	1
B 41	1/2"	4	19	1
B 42	1/2"	4	24	1
B 51	5/8"	5	28	1
B 61	3/4"	5	36	1
B 62	3/4"	5	45	1
B 81	1"	7	45	1
B 82	1"	7	57	1
B 83	1"	7	75	1
B 71	1 1/2"	10	75	1
B 72	1 1/2"	10	114	1
B 91	2 1/2"	10.5	114	1
B 92	2 1/2"	10.5	158	1
B 01	3 1/2"	15	158	1
B 02	3 1/2"	15	183	1

NOTE

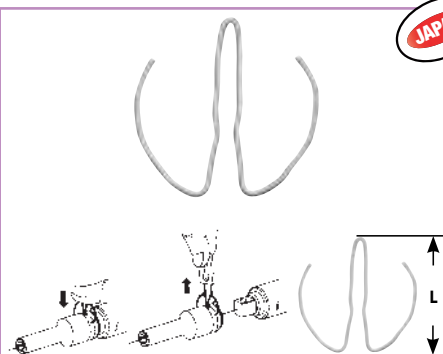

MOLLA DI SICUREZZA PER BUSSOLE

Kokoen articolo	Ø	Ø	L mm	
C 31	3/8"	≤ 12	18	1
C 32	3/8"	> 12	20	1
C 41	1/2"	≤ 14	23	1
C 42	1/2"	> 14	26	1
C 61	3/4"	≤ 46	41	1
C 81	1"	≤ 46	50	1
C 82	1"	> 46		1
C 83	1"	> 70		1
C 71	1 1/2"	≤ 90		1



ESTRATTORE PER MOLLE DI SICUREZZA

Kokoen articolo	Ø	
149	3/8" - 1/2"	1
152	3/4" - 1"	1

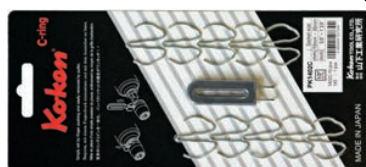

SET MOLLE DI SICUREZZA PER BUSSOLE

Kokoen articolo	nr.	
PKC 31	10	149 1
PKC 32	10	149 1
PKC 41	10	149 1
PKC 42	10	149 1
PKC 61	10	152 1
PKC 81	10	152 1



ESAGONO

CHIAVI A BUSSOLA
GUIDATE ANTI VIBRAZIONI
BOCCA ESAGONALE

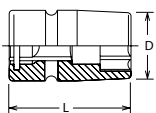

Kokon articolo	mm	D mm	L mm	
NV 14400M-12	12	19.5	52	1
NV 14400M-13	13	20.7	52	1
NV 14400M-14	14	22	54	1
NV 14400M-15	15	23.2	54	1
NV 14400M-16	16	24.5	54	1
NV 14400M-17	17	25.7	54	1
NV 14400M-18	18	27	54	1
NV 14400M-19	19	28.2	54	1
NV 14400M-21	21	30.7	54	1
NV 14400M-22	22	32	54	1
NV 14400M-23	23	33.2	54	1
NV 14400M-24	24	34.5	54	1

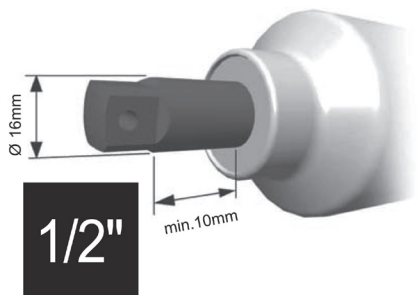

ESAGONO

CHIAVI A BUSSOLA
GUIDATE ANTI
VIBRAZIONI
BOCCA ESAGONALE
EXTRA LUNGHE

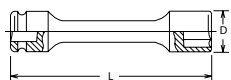

Kokon articolo	mm	D mm	L mm	
NV 14145M-100-10	10	15.5	100	1
NV 14145M-100-12	12	18	100	1
NV 14145M-100-13	13	19	100	1
NV 14145M-100-14	14	21	100	1
NV 14145M-100-15	15	22	100	1
NV 14145M-100-16	16	24	100	1
NV 14145M-100-17	17	25	100	1
NV 14145M-100-18	18	26	100	1
NV 14145M-100-19	19	28	100	1
NV 14145M-150-10	10	15.5	150	1
NV 14145M-150-12	12	18	150	1
NV 14145M-150-13	13	19	150	1
NV 14145M-150-14	14	21	150	1
NV 14145M-150-15	15	22	150	1
NV 14145M-150-16	16	24	150	1
NV 14145M-150-17	17	25	150	1
NV 14145M-150-18	18	26	150	1
NV 14145M-150-19	19	28	150	1
NV 14145M-200-10	10	15.5	200	1
NV 14145M-200-12	12	18	200	1
NV 14145M-200-13	13	19	200	1
NV 14145M-200-14	14	21	200	1
NV 14145M-200-15	15	22	200	1
NV 14145M-200-16	16	24	200	1
NV 14145M-200-17	17	25	200	1
NV 14145M-200-18	18	26	200	1
NV 14145M-200-19	19	28	200	1



PROLUNGA ANTI VIBRAZIONI

Kokon articolo	D mm	L mm	
NV 14760-75P	25	75	1
NV 14760-125P	25	125	1
NV 14760-175P	25	175	1
NV 14760-250P	25	250	1



1/2"

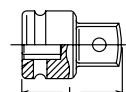

3/8"

ADATTATORE ANTI VIBRAZIONI
CON ATTACCO QUADRO
MASCHIO 3/8" E FEMMINA 1/2"

Kokon articolo	L mm	
NV 14433A-75P	75	1
NV 14433A-100P	100	1
NV 14433A-150P	150	1



1/2"

1/4" E
7/16"

ELIMINAZIONE DELLE VIBRAZIONI
LA PROLUNGA DEL MANDRINO CALZA
SULLA PARETE CILINDRICA DELL' ALBERO
DELL'AVVITATORE
ATTENZIONE: CONTROLLARE LA
LUNGHEZZA DELL'ALBERO!

attacco: Quadro femmina 1/2"
impronta: E 6,35

articolo	mm	L mm	
NV 1214 1/2"	1/4" E	60	1
NV 12716 1/2"	7/16"	63	1



1/2"

7/16"

BUSSOLA
PORTAINSERTI
ANTI
VIBRAZIONI
DA 7/16"

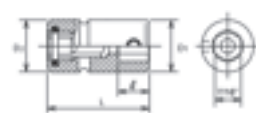

Kokon articolo	D mm	L mm	
NV 14134	22.5	55	1



1/2"

1/2"

MANDRINI ANTIVIBRAZIONE PORTABUSSOLE
E SGANCIO RAPIDO
ATTENZIONE: CONTROLLARE LA LUNGHEZZA
DELL'ALBERO!

articolo	mm	L mm	
NV 197	1/2"	100	1

Guidate antivibrazioni



JAPAN

ESAGONO

CHIAVI A BUSSOLA A MACCHINA BOCCA ESAGONALE

Koken articolo	mm	D mm	L mm	
15400M-14	14	24	47.5	1
15400M-17	17	27.8	47.5	1
15400M-19	19	30.3	47.5	1
15400M-21	21	32.8	47.5	1
15400M-22	22	34	47.5	1
15400M-23	23	35.4	47.5	1
15400M-24	24	36.5	50.5	1
15400M-26	26	39	50.5	1



JAPAN

ESAGONO

CHIAVI A BUSSOLA A MACCHINA BOCCA ESAGONALE TIPO LUNGO

Koken articolo	mm	D mm	L mm	
15300M-14	14	22	80	1
15300M-17	17	25.7	80	1
15300M-19	19	28.2	80	1
15300M-21	21	30.7	80	1
15300M-22	22	32	85	1



JAPAN

FORO

5/8" 5/8"

SNODO attacco: 5/8"

Koken articolo	F	M	L mm	
15770	5/8"	5/8"	88	1



JAPAN

SURFACE DRIVE

CHIAVI A BUSSOLA A MACCHINA BOCCA SURFACE DRIVE

Koken articolo	mm	D mm	L mm	
15410M-14	14	24	47.5	1
15410M-17	17	27.8	47.5	1
15410M-19	19	30.3	47.5	1
15410M-21	21	32.8	47.5	1
15410M-22	22	34	47.5	1
15410M-23	23	35.4	47.5	1
15410M-24	24	36.5	50.5	1
15410M-26	26	39	50.5	1



JAPAN

SURFACE DRIVE

CHIAVI A BUSSOLA A MACCHINA BOCCA SURFACE DRIVE TIPO LUNGO

Koken articolo	mm	D mm	L mm	
15310M-14	14	22	80	1
15310M-17	17	25.7	80	1
15310M-19	19	28.2	80	1
15310M-21	21	30.7	80	1
15310M-22	22	32	85	1

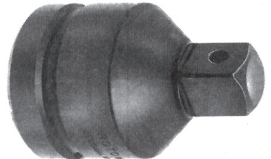

JAPAN

PERNO FORO

RACCORDI DI RIDUZIONE "POWER IMPACT" MASCHIO/FEMMINA

Koken articolo	F	M	L mm	
15544 A-P PERNO	5/8"	1/2"	46	1
15544 A FORO	5/8"	1/2"	46	1
16655 A FORO	3/4"	5/8"	53	1
15566 A FORO	5/8"	3/4"	48	1
14455 A FORO	1/2"	5/8"	42	1



JAPAN

SFERA

5/8" 5/8"

SGANCIO RAPIDO - Lock & Quick Release

LOCK RELEASE

MANDRINO CON SGANCIO RAPIDO PER BUSSOLE "POWER IMPACT" MASCHIO 5/8" E FEMMINA 5/8"

Koken articolo	L mm	
15555 AL	70	1

IMPACT 5/8"





CASSETTE METALLICHE PORTA-BUSSOLE

FEARMEC articolo	lunghezza (mm)	larghezza (mm)	altezza (mm)	
CASS-2510	240	100	60	1
CASS-2810	280	130	75	1
CASS-3009	300	90	45	1
CASS-3112	310	120	80	1
CASS-3211	320	120	50	1
CASS-4220	420	200	140	1
CASS-6213	610	130	80	1

NOTE

- a richiesta assortimenti di bussole a macchina in cassetta metallica



PRO+

GUIDE PORTA BUSSOLE CON CLIP



BGS articolo		Numero Clip
BGS 2316	1/4"	7
BGS 2317	3/8"	7
BGS 2318	1/2"	7
BGS 2120	1/4"	15
BGS 2330	3/8"	15
BGS 2540	1/2"	15
BGS 3460	3/4"	12

CARATTERISTICHE

- cromato satinato



MOLLE IN ACCIAIO PER GUIDE

Kokon articolo		
C 14	1/4"	1
C 38	3/8"	1
C 12	1/2"	1
C 34	3/4"	1

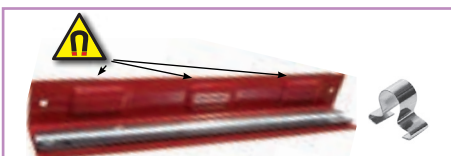

GUIDA MAGNETICA PER MOLLE PORTA BUSSOLE DA 1/4" - 3/8" - 1/2" - 3/4"

FEARMEC articolo	L mm	
MAG 300	300	1



GUIDE PORTA BUSSOLE PER MOLLE IN ACCIAIO DA 1/4" - 3/8" - 1/2" - 3/4"

Kokon articolo	L mm	
R 158	158	1
R 251	251	1
R 300	300	1
R 400	400	1

BGS HANGER-1



1/4"

BGS HANGER-2



3/8"

BGS HANGER-3



1/2"

BGS HANGER-4



3/4"

BGS HANGER-5



1"



CLIP X ATTACCO QUADRO FEMMINA

BGS articolo	
BGS HANGER-1	1/4"
BGS HANGER-2	3/8"
BGS HANGER-3	1/2"
BGS HANGER-4	3/4"
BGS HANGER-5	1"

CARATTERISTICHE

- clip in plastica con quadro maschio
- ad esempio per esposizione bussole



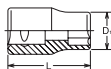

ESAGONO
**CHIAVI A BUSSOLA
A MANO BOCCA
ESAGONALE**

Koken articolo	mm	D mm	L mm	
6400M-14	14	22.1	50	1
6400M-16	16	24.6	50	1
6400M-17	17	26	50	1
6400M-18	18	27	50	1
6400M-19	19	28.5	50	1
6400M-20	20	29.5	50	1
6400M-21	21	31	50	1
6400M-22	22	32	50	1
6400M-23	23	33.5	50	1
6400M-24	24	34.5	50	1
6400M-25	25	36	50	1
6400M-26	26	37	50	1
6400M-27	27	38.5	53	1
6400M-28	28	39.5	53	1
6400M-29	29	41	53	1
6400M-30	30	42	55	1
6400M-31	31	43.5	55	1
6400M-32	32	44.5	57	1
6400M-33	33	46	57	1
6400M-34	34	47	57	1
6400M-35	35	48.5	57	1
6400M-36	36	49.5	59	1
6400M-37	37	51	59	1
6400M-38	38	52	59	1
6400M-39	39	53.5	59	1
6400M-40	40	54.5	59	1
6400M-41	41	56	62	1
6400M-42	42	57	62	1
6400M-43	43	58.5	62	1
6400M-44	44	59.5	62	1
6400M-45	45	61	62	1
6400M-46	46	62	68	1
6400M-47	47	63.5	68	1
6400M-48	48	64.5	68	1
6400M-50	50	67	68	1
6400M-52	52	69.5	72	1
6400M-54	54	72	72	1
6400M-55	55	73.5	72	1
6400M-56	56	74.5	72	1
6400M-57	57	76	72	1
6400M-58	58	77	72	1
6400M-60	60	79.5	76	1
6400M-63	63	83.5	76	1
6400M-65	65	86	80	1
6400M-70	70	92	84	1
6400M-75	75	98.5	86	1
6400M-78	78	102.1	86	1
6400M-80	80	104.5	90	1
6400M-85	85	111	90	1

POLLICI

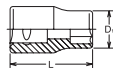

ESAGONO
**CHIAVI A BUSSOLA
A MANO BOCCA
ESAGONALE**



Koken articolo	pollici	D mm	L mm	
6400A-5/8	5/8"	24.6	50	1
6400A-11/16	11/16"	27	50	1
6400A-3/4	3/4"	28.5	50	1
6400A-25/32	25/32"	29.5	50	1
6400A-13/16	13/16"	31	50	1
6400A-7/8	7/8"	32	50	1
6400A-15/16	15/16"	34.5	50	1
6400A-31/32	31/32"	36	50	1
6400A-1	1"	37	50	1
6400A-1-1/16	1-1/16"	38.5	53	1
6400A-1-1/8	1-1/8"	41	53	1
6400A-1-3/16	1-3/16"	42	55	1
6400A-1-1/4	1-1/4"	44.5	57	1
6400A-1-5/16	1-5/16"	46	57	1
6400A-1-3/8	1-3/8"	48.5	57	1
6400A-1-7/16	1-7/16"	51	59	1
6400A-1-1/2	1-1/2"	52	59	1
6400A-1-9/16	1-9/16"	54.5	59	1
6400A-1-5/8	1-5/8"	56	62	1
6400A-1-11/16	1-11/16"	58.5	62	1
6400A-1-3/4	1-3/4"	59.5	62	1
6400A-1-13/16	1-13/16"	62	68	1
6400A-1-7/8	1-7/8"	64.5	68	1
6400A-1-15/16	1-15/16"	66	68	1
6400A-2	2"	68.5	68	1
6400A-2-1/16	2-1/16"	71	72	1
6400A-2-1/8	2-1/8"	72	72	1
6400A-2-3/16	2-3/16"	74.5	72	1
6400A-2-1/4	2-1/4"	76	72	1
6400A-2-5/16	2-5/16"	78.5	72	1
6400A-2-3/8	2-3/8"	79.5	76	1
6400A-2-7/16	2-7/16"	82	76	1
6400A-2-1/2	2-1/2"	84.5	76	1
6400A-2-9/16	2-9/16"	86	80	1
6400A-2-5/8	2-5/8"	88.5	80	1
6400A-2-11/16	2-11/16"	89.5	80	1
6400A-2-3/4	2-3/4"	92	84	1
6400A-2-13/16	2-13/16"	94.5	84	1
6400A-2-7/8	2-7/8"	96	84	1
6400A-2-15/16	2-15/16"	98.5	86	1
6400A-3	3"	101	86	1
6400A-3-1/8	3-1/8"	104.5	90	1

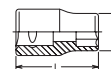



POLIGONALE
**CHIAVI A BUSSOLA
A MANO BOCCA
POLIGONALE**

Koken articolo	mm	D mm	L mm	
6405M-14	14	22.1	50	1
6405M-16	16	24.6	50	1
6405M-17	17	26	50	1
6405M-18	18	27	50	1
6405M-19	19	28.5	50	1
6405M-20	20	29.5	50	1
6405M-21	21	31	50	1
6405M-22	22	32	50	1
6405M-23	23	33.5	50	1
6405M-24	24	34.5	50	1
6405M-25	25	36	50	1
6405M-26	26	37	50	1
6405M-27	27	38.5	53	1
6405M-28	28	39.5	53	1
6405M-29	29	41	53	1
6405M-30	30	42	55	1
6405M-31	31	43.5	55	1
6405M-32	32	44.5	57	1
6405M-33	33	46	57	1
6405M-34	34	47	57	1
6405M-35	35	48.5	57	1
6405M-36	36	49.5	59	1
6405M-37	37	51	59	1
6405M-38	38	52	59	1
6405M-39	39	53.5	59	1
6405M-40	40	54.5	59	1
6405M-41	41	56	62	1
6405M-42	42	57	62	1
6405M-43	43	58.5	62	1
6405M-44	44	59.5	62	1
6405M-45	45	61	62	1
6405M-46	46	62	68	1
6405M-47	47	63.5	68	1
6405M-48	48	64.5	68	1
6405M-50	50	67	68	1
6405M-52	52	69.5	72	1
6405M-54	54	72	72	1
6405M-55	55	73.5	72	1
6405M-56	56	74.5	72	1
6405M-57	57	76	72	1
6405M-58	58	77	72	1
6405M-60	60	79.5	76	1
6405M-63	63	83.5	76	1
6405M-65	65	86	80	1
6405M-70	70	92	84	1
6405M-75	75	98.5	86	1
6405M-78	78	102.1	86	1
6405M-80	80	104.5	90	1
6405M-85	85	111	90	1

CHIAVE A BUSSOLA PER DADI MOZZI RUOTE

FEINTEC articolo	mm	D mm	L mm	
6400M-36R	36	46	59	1



CHIAVE A BUSSOLA PER DADI MOZZI RUOTE

FEINTEC articolo	mm	D mm	L mm	
6405M-36R	36	46	59	1

POLLICI



**CHIAVI A BUSSOLA
A MANO BOCCA
POLIGONALE**

Koken articolo	pollici	D mm	L mm	
6405A-5/8	5/8"	24.6	50	1
6405A-11/16	11/16"	27	50	1
6405A-3/4	3/4"	28.5	50	1
6405A-25/32	25/32"	29.5	50	1
6405A-13/16	13/16"	31	50	1
6405A-7/8	7/8"	32	50	1
6405A-15/16	15/16"	34.5	50	1
6405A-31/32	31/32"	36	50	1
6405A-1	1"	37	50	1
6405A-1-1/16	1-1/16"	38.5	53	1
6405A-1-1/8	1-1/8"	41	53	1
6405A-1-3/16	1-3/16"	42	55	1
6405A-1-1/4	1-1/4"	44.5	57	1
6405A-1-5/16	1-5/16"	46	57	1
6405A-1-3/8	1-3/8"	48.5	57	1
6405A-1-7/16	1-7/16"	51	59	1
6405A-1-1/2	1-1/2"	52	59	1
6405A-1-9/16	1-9/16"	54.5	59	1
6405A-1-5/8	1-5/8"	56	62	1
6405A-1-11/16	1-11/16"	58.5	62	1
6405A-1-3/4	1-3/4"	59.5	62	1
6405A-1-13/16	1-13/16"	62	68	1
6405A-1-7/8	1-7/8"	64.5	68	1
6405A-1-15/16	1-15/16"	66	68	1
6405A-2	2"	68.5	68	1
6405A-2-1/16	2-1/16"	71	72	1
6405A-2-1/8	2-1/8"	72	72	1
6405A-2-3/16	2-3/16"	74.5	72	1
6405A-2-1/4	2-1/4"	76	72	1
6405A-2-5/16	2-5/16"	78.5	72	1
6405A-2-3/8	2-3/8"	79.5	76	1
6405A-2-7/16	2-7/16"	82	76	1
6405A-2-1/2	2-1/2"	84.5	76	1
6405A-2-9/16	2-9/16"	86	80	1
6405A-2-5/8	2-5/8"	88.5	80	1
6405A-2-11/16	2-11/16"	89.5	80	1
6405A-2-3/4	2-3/4"	92	84	1
6405A-2-13/16	2-13/16"	94.5	84	1
6405A-2-7/8	2-7/8"	96	84	1
6405A-2-15/16	2-15/16"	98.5	86	1
6405A-3	3"	101	86	1
6405A-3-1/8	3-1/8"	104.5	90	1

3/4"

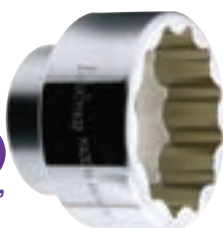

POLIGONALE



**CHIAVI A BUSSOLA A
MANO BOCCA POLIGONALE
EXTRA CORTE PER DADO
ASSE POSTERIORE MOTO**

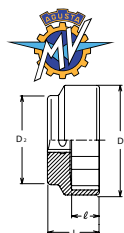



Koken articolo	pollici	D ₁ mm	L mm	
6405A-MV-2-3/16	2-3/16"	74.6	52	1

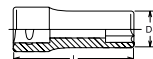

ESAGONO

**CHIAVI A BUSSOLA
A MANO BOCCA
ESAGONALE LUNGHE**



Koken articolo	mm	D mm	L mm	
6300M-17	17	26	90	1
6300M-18	18	27	90	1
6300M-19	19	28.5	90	1
6300M-20	20	29.5	90	1
6300M-21	21	31	90	1
6300M-22	22	32	90	1
6300M-23	23	33.5	90	1
6300M-24	24	34.5	90	1
6300M-25	25	36	90	1
6300M-26	26	37	90	1
6300M-27	27	38.5	90	1
6300M-28	28	39.5	90	1
6300M-29	29	41	90	1
6300M-30	30	42	90	1
6300M-31	31	43.5	90	1
6300M-32	32	44.5	90	1
6300M-33	33	46	90	1
6300M-34	34	47	90	1
6300M-35	35	48.5	90	1
6300M-36	36	49.5	90	1
6300M-38	38	52	90	1
6300M-40	40	54.5	90	1
6300M-41	41	56	90	1
6300M-42	42	57	90	1
6300M-44	44	59.5	90	1
6300M-46	46	62	90	1
6300M-48	48	64.5	90	1
6300M-50	50	67	90	1
6300M-52	52	69.5	100	1
6300M-53	53	71	100	1
6300M-54	54	72	100	1
6300M-55	55	73.5	100	1
6300M-56	56	74.5	100	1
6300M-57	57	76	100	1
6300M-58	58	77	100	1
6300M-60	60	79.5	100	1
6300M-63	63	83.5	100	1
6300M-65	65	86	100	1

KOKEN 3/4"

**PER DADI →
MOZZI RUOTE**

FEMEC articolo	mm	D mm	L mm	
6300M-36R	36	46	90	1

POLLICI



ESAGONO

CHIAVI A BUSSOLA
A MANO BOCCA
ESAGONALE LUNGHE

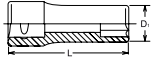

Koken articolo	pollici	D mm	L mm	
6300A-3/4	3/4"	28.5	90	1
6300A-25/32	25/32"	29.5	90	1
6300A-13/16	13/16"	31	90	1
6300A-7/8	7/8"	32	90	1
6300A-15/16	15/16"	34.5	90	1
6300A-1	1"	37	90	1
6300A-1-1/16	1-1/16"	38.5	90	1
6300A-1-1/8	1-1/8"	41	90	1
6300A-1-3/16	1-3/16"	42	90	1
6300A-1-1/4	1-1/4"	44.5	90	1
6300A-1-5/16	1-5/16"	46	90	1
6300A-1-3/8	1-3/8"	48.5	90	1
6300A-1-7/16	1-7/16"	51	90	1
6300A-1-1/2	1-1/2"	52	90	1
6300A-1-9/16	1-9/16"	54.5	90	1
6300A-1-5/8	1-5/8"	56	90	1
6300A-1-11/16	1-11/16"	58.5	90	1
6300A-1-3/4	1-3/4"	59.5	90	1
6300A-1-13/16	1-13/16"	62	90	1
6300A-2	2"	68.5	90	1
6300A-2-1/16	2-1/16"	71	100	1
6300A-2-1/8	2-1/8"	72	100	1
6300A-2-3/16	2-3/16"	74.5	100	1
6300A-2-1/4	2-1/4"	76	100	1
6300A-2-5/16	2-5/16"	78.5	100	1
6300A-2-3/8	2-3/8"	79.5	100	1
6300A-2-7/16	2-7/16"	82	100	1



POLIGONALE

CHIAVI A BUSSOLA
A MANO BOCCA
POLIGONALE LUNGHE

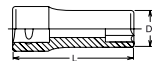

Koken articolo	mm	D mm	L mm	
6305M-17	17	26	90	1
6305M-18	18	27	90	1
6305M-19	19	28.5	90	1
6305M-20	20	29.5	90	1
6305M-21	21	31	90	1
6305M-22	22	32	90	1
6305M-23	23	33.5	90	1
6305M-24	24	34.5	90	1
6305M-25	25	36	90	1
6305M-26	26	37	90	1
6305M-27	27	38.5	90	1
6305M-28	28	39.5	90	1
6305M-29	29	41	90	1
6305M-30	30	42	90	1
6305M-31	31	43.5	90	1
6305M-32	32	44.5	90	1
6305M-33	33	46	90	1
6305M-34	34	47	90	1
6305M-35	35	48.5	90	1
6305M-36	36	49.5	90	1
6305M-38	38	52	90	1
6305M-40	40	54.5	90	1
6305M-41	41	56	90	1
6305M-42	42	57	90	1
6305M-44	44	59.5	90	1
6305M-46	46	62	90	1
6305M-48	48	64.5	90	1
6305M-50	50	67	90	1
6305M-52	52	69.5	100	1
6305M-53	53	71	100	1
6305M-54	54	72	100	1
6305M-55	55	73.5	100	1
6305M-56	56	74.5	100	1
6305M-57	57	76	100	1
6305M-58	58	77	100	1
6305M-60	60	79.5	100	1
6305M-63	63	83.5	100	1
6305M-65	65	86	100	1

POLLICI



POLIGONALE

CHIAVI A BUSSOLA
A MANO BOCCA
POLIGONALE LUNGHE



Koken articolo	pollici	D mm	L mm	
6305A-3/4	3/4"	28.5	90	1
6305A-25/32	25/32"	29.5	90	1
6305A-13/16	13/16"	31	90	1
6305A-7/8	7/8"	32	90	1
6305A-15/16	15/16"	34.5	90	1
6305A-1	1"	37	90	1
6305A-1-1/16	1-1/16"	38.5	90	1
6305A-1-1/8	1-1/8"	41	90	1
6305A-1-3/16	1-3/16"	42	90	1
6305A-1-1/4	1-1/4"	44.5	90	1
6305A-1-5/16	1-5/16"	46	90	1
6305A-1-3/8	1-3/8"	48.5	90	1
6305A-1-7/16	1-7/16"	51	90	1
6305A-1-1/2	1-1/2"	52	90	1
6305A-1-9/16	1-9/16"	54.5	90	1
6305A-1-5/8	1-5/8"	56	90	1
6305A-1-11/16	1-11/16"	58.5	90	1
6305A-1-3/4	1-3/4"	59.5	90	1
6305A-1-13/16	1-13/16"	62	90	1
6305A-2	2"	68.5	90	1
6305A-2-1/16	2-1/16"	71	100	1
6305A-2-1/8	2-1/8"	72	100	1
6305A-2-3/16	2-3/16"	74.5	100	1
6305A-2-1/4	2-1/4"	76	100	1
6305A-2-5/16	2-5/16"	78.5	100	1
6305A-2-3/8	2-3/8"	79.5	100	1
6305A-2-7/16	2-7/16"	82	100	1



TAGLIO

CHIAVI A BUSSOLA
A TAGLIO

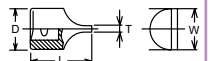

Koken articolo	mm	D mm	L mm	
6101 K	6,4 x 33,5	35	50	1

CHIAVE A BUSSOLA
PER DADI MOZZI RUOTE



FEINTEC articolo	mm	D mm	L mm	
6305M-36R	36	46	90	1

PER DADI
MOZZI RUOTE

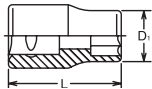

CHIAVI A BUSSOLA A MANO BOCCA TORX®





Koken articolo		D ₁ mm	L mm	
6425-E18	E 18	22.1	50	1
6425-E20	E 20	24.6	50	1
6425-E22	E 22	27.1	50	1
6425-E24	E 24	28.6	50	1
6425-E26	E 26	31.1	55	1
6425-E28	E 28	32.1	60	1
6425-E30	E 30	35.0	60	1
6425-E32	E 32	36.1	60	1

TORX®	S mm	S mm	
E 4	3.70	E 16	14.60
E 5	4.60	E 18	16.50
E 6	5.60	E 20	18.30
E 7	6.10	E 22	20.10
E 8	7.40	E 24	22.00
E 10	9.30	E 26	23.70
E 11	9.90	E 28	25.50
E 12	11.00	E 30	27.30
E 14	12.80	E 32	29.00

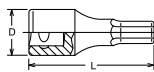

CHIAVI A BUSSOLA MASCHIO ESAGONALE INTEGRALE



Koken articolo		D mm	L mm	
6012M-12	12	35	75	1
6012M-14	14	35	75	1
6012M-15	15	35	75	1
6012M-16	16	35	75	1
6012M-17	17	35	75	1
6012M-18	18	35	75	1
6012M-19	19	35	75	1
6012M-20	20	35	75	1
6012M-21	21	38	75	1
6012M-22	22	38	75	1
6012M-24	24	38	75	1
6012M-27	27	38	75	1
6012M-30	30	38	75	1
6012M-32	32	38	75	1
6012M-36	36	42	75	1



SFERA

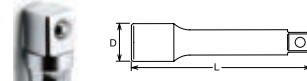



PROLUNGHE CON ATTACCO QUADRO

Koken articolo	D mm	L mm	
6760-75	35	75	1
6760-100	35	100	1
6760-125	35	125	1
6760-150	35	150	1
6760-200	35	200	1
6760-300	35	300	1
6760-400	35	400	1

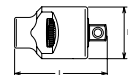

ADATTATORE A CRICCHETTO COPPIA MASSIMA: 800 NM



Koken articolo	D mm	L mm	
6755	62	97	1

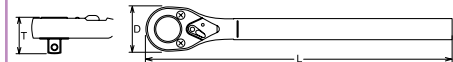

CRICCHETTO PORTABUSSOLA REVERSIBILE

Koken articolo	D mm	T mm	L mm	
6749	68	49,6	565	1
6749-1000	68	49,6	965	1

novità AMBIO CRICCHETTO

6749-HEAD	68	49.6	165	1
-----------	----	------	-----	---

RICAMBI MANICO

PIPE-400	-	-	400	1
PIPE-800	-	-	800	1

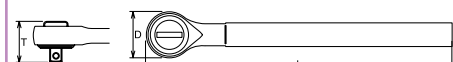

CRICCHETTO PORTABUSSOLA REVERSIBILE

Koken articolo	D mm	T mm	L mm	
6752	67	55,5	500	1

novità AMBIO CRICCHETTO

6752-HEAD	67	55.5	100	1
-----------	----	------	-----	---

RICAMBIO MANICO

PIPE-400	-	-	400	1
----------	---	---	-----	---

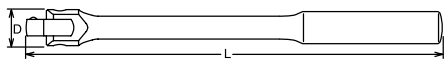

QUADRO MASCHIO SNODATO, INTEGRALE

Kokken articolo	D mm	L mm	
6768-450	42	450	1

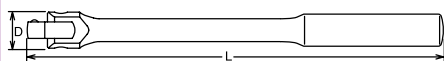
QUADRO MASCHIO SNODATO, IN 2 PEZZI

Kokken articolo	D mm	L mm	
6768-600	42	600	1
6768-1000	42	1000	1

RICAMBIO TESTA

6768-HEAD <i>novità</i>	42	200	1
-------------------------	----	-----	---

RICAMBI MANICO

PIPE-400	400	1
PIPE-800	800	1

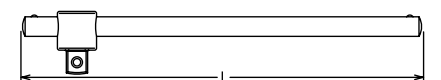
ASTA OVALE

L'innovativa barra a forma ovale offre una maggiore durata e impedisce al quadro scorrevole di ruotare attorno l'asta.

QUADRO MASCHIO CON ASTA SCORREVOLE

Kokken articolo	L mm	
6785	500	1

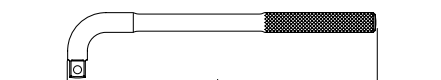

QUADRO MASCHIO AD ANGOLO

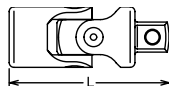
Kokken articolo	L mm	
6788	330	1

SFERA

SNODO

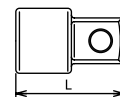
Kokken articolo	L mm	
6770	105	1





SFERA

RACCORDO DI RIDUZIONE MASCHIO/FEMMINA CON SFERA DI TENUTA NEL QUADRO MASCHIO



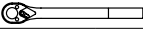

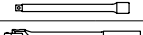
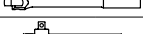

Kokken articolo	F	M	L mm	
2233 A	1/4"	3/8"	22	1
3322 A	3/8"	1/4"	24	1
3344 A	3/8"	1/2"	35	1
4433 A-35	1/2"	3/8"	35	1
4433 A-75	1/2"	3/8"	75	1
4433 A-125	1/2"	3/8"	125	1
4433 A-250	1/2"	3/8"	250	1
4433 A-600	1/2"	3/8"	600	1
4466 A	1/2"	3/4"	42	1
6644 A	3/4"	1/2"	47	1
6688 A	3/4"	1"	60	1
8866 A	1"	3/4"	60	1

NOTE



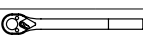

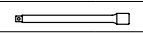
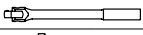

Koken articolo	DESCRIZIONE	
6201M-00	Cassetta metallica 16 Pz. 580 x 200 x h 85 mm	
RICAMBI		
BUSSOLE 	6400M	22, 24, 27, 30, 32, 36, 41, 46, 50, 55, 60
ACCESSORI	6749	
	6760-200	
	6760-400	
	6768	
	6785	



Koken articolo	DESCRIZIONE	
6201M-05	Cassetta metallica 16 Pz. 580 x 200 x h 85 mm	
RICAMBI		
BUSSOLE 	6405M	22, 24, 27, 30, 32, 36, 41, 46, 50, 55, 60
ACCESSORI	6749	
	6760-200	
	6760-400	
	6768	
	6785	

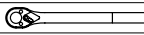
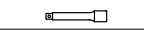

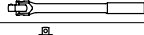

POLLICI



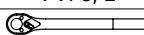

Koken articolo	DESCRIZIONE	
6201A-00	Cassetta metallica 18 Pz. 580 x 200 x h 85 mm	
RICAMBI		
BUSSOLE 	6400A	7/8, 15/16, 1-1/16, 1-1/8, 1-1/4, 1-5/16, 1-7/16, 1-1/2, 1-5/8, 1-11/16, 1-13/16, 1-7/8, 2
ACCESSORI	6749	
	6760-200	
	6760-400	
	6768	
	6785	

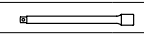
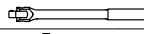
POLLICI



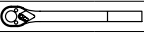
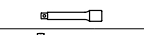

Koken articolo	DESCRIZIONE	
6201A-05	Cassetta metallica 16 Pz. 580 x 200 x h 85 mm	
RICAMBI		
BUSSOLE 	6405A	7/8, 15/16, 1-1/16, 1-1/8, 1-1/4, 1-5/16, 1-7/16, 1-1/2, 1-5/8, 1-11/16, 1-13/16, 1-7/8, 2
ACCESSORI	6749	
	6760-200	
	6760-400	
	6768	
	6785	



Koken articolo	DESCRIZIONE	
6212M-00	Cassetta metallica 16 Pz. 580 x 124 x h 70 mm	
RICAMBI		
BUSSOLE 	6400M	22, 24, 27, 30, 32, 36, 41, 46, 50
ACCESSORI	6749	
	6760-200	
	6785	

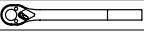

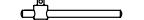
Koken articolo	DESCRIZIONE	
6212M-05	Cassetta metallica 16 Pz. 580 x 124 x h 70 mm	
RICAMBI		
BUSSOLE 	6405M	22, 24, 27, 30, 32, 36, 41, 46, 50
ACCESSORI	6749	
	6760-200	
	6785	





3/4"



ESAGONO

**BUSSOLE CHROM-VANADIUM
CON FORO NEL QUADRO**

Attacco: 3/4"

impronta: ESAGONO

BGS articolo	mm	L mm.	
BGS 3419	19	50	1
BGS 3421	21	50	1
BGS 3422	22	50	1
BGS 3423	23	50	1
BGS 3424	24	50	1
BGS 3426	26	50	1
BGS 3427	27	50	1
BGS 3430	30	55	1
BGS 3432	32	55	1
BGS 3433	33	55	1
BGS 3434	34	55	1
BGS 3435	35	55	1
BGS 3436	36	60	1
BGS 3438	38	60	1
BGS 3441	41	65	1
BGS 3442	42	65	1
BGS 3444	44	65	1
BGS 3446	46	70	1
BGS 3448	48	70	1
BGS 3450	50	70	1
BGS 3454 novità	54	70	1
BGS 3455	55	70	1
BGS 1207-60	60	80	1
BGS 3465 novità	65	80	1

**MILLIMETRI
E POLLICI**

PRO+

BUSSOLE UNIVERSALE

BGS articolo	PER MISURE	
BGS 2533	3/8" 9-19 MM	1
BGS 2531	1/2" 11-30 MM	1
BGS 2833	3/4" 12-38 MM	1

CARATTERISTICHE

- adatta a tutte le impronte esagonali anche in pollici



3/4"



POLIGONALE

**BUSSOLE CHROM-VANADIUM POLIGONALI
CON FORO NEL QUADRO**

Attacco: 3/4"

impronta: POLIGONALI

BGS articolo	mm	L mm	
BGS 7419	19	50	1
BGS 7421	21	50	1
BGS 7422	22	50	1
BGS 7424	24	50	1
BGS 7427	27	50	1
BGS 7430	30	55	1
BGS 7432	32	55	1
BGS 7434	34	55	1
BGS 7436	36	60	1
BGS 7438	38	60	1
BGS 7441	41	65	1
BGS 7446	46	70	1
BGS 7450	50	70	1
BGS 7455	55	70	1
BGS 7459	60	70	1
BGS 7465	65	70	1
BGS 7466	70	70	1



3/4"



ESAGONO

PRO+

CHIAVI A BUSSOLA MASCHIO ESAGONALI

BGS articolo	mm	L mm	
BGS 5189-H14	14	85	1
BGS 5189-H17	17	85	1
BGS 5189-H19	19	85	1
BGS 5189-H22	22	85	1

CARATTERISTICHE



- finitura satinata cromata
- zigrinate



3/4"

PRO+

CHIAVI A BUSSOLA MASCHIO TORX

BGS articolo	 L mm	
BGS 5189-T60	TX 60 80	1
BGS 5189-T70	TX 70 80	1
BGS 5189-T80	TX 80 80	1
BGS 5189-T90	TX 90 80	1
BGS 5189-T100	TX 100 80	1

CARATTERISTICHE

- finitura satinata cromata
- zigrinate

**ARTICOLO IN
ESAURIMENTO**

BGS articolo	DESCRIZIONE
BGS 5189	SET 9 PEZZI, BUSSOLE ATT. 3/4", ESAGONALI E TORX

CARATTERISTICHE

- comprende:
 - bussole Esagonali, lunghezza 85 mm: 14 - 17 - 19 - 22 mm
 - bussole Torx, lunghezza 80 mm: TX60 - TX70 - TX80 - TX90 - TX100
- zigrinate
- finitura satinata cromata
- peso: 5,0 kg

TORX®	S mm	S mm	
T 6	1.70	T 40	6.70
T 7	2.00	T 45	7.90
T 8	2.30	T 50	8.90
T 9	2.50	T 55	11.30
T 10	2.70	T 60	13.30
T 15	3.30	T 70	15.60
T 20	3.90	T 80	17.60
T 25	4.50	T 90	20.00
T 27	5.00	T 100	22.20
T 30	5.60		

ADATTATORI DOPPIO QUADRO MASCHIO

FEWMEC articolo	3/4"	L mm
2841	1/4"	20
3841	3/8"	30
4841	1/2"	37
BGS 9623	3/4"	53
8841	1"	68

CARATTERISTICHE

- con doppia sfera

CRICCHETTO REVERSIBILE CON QUADRO FEMMINA PASSANTE

FEWMEC articolo	3/4"	L mm
BGS 9160	1/4"	115
BGS 312	1/2"	270
BGS 9622	3/4"	500

CARATTERISTICHE

- quadro passante
- impugnatura rivestita

PROLUNGHE
attacco: 3/4"

BGS articolo	L mm	
BGS 264	100	1
BGS 266	200	1
BGS 268	400	1

RACCORDI DI RIDUZIONE CHROM-VANADIUM
attacco: 1/4" - 3/8" - 1/2" - 3/4"

BGS articolo	FEMMINA	MASCHIO	
BGS 271	1/4"	3/8"	1
BGS 269	3/8"	1/4"	1
BGS 280	3/8"	1/2"	1
BGS 270	1/2"	3/8"	1
BGS 272	1/2"	3/4"	1
BGS 274	3/4"	1/2"	1

PRO+ CV

BGS articolo	DESCRIZIONE
BGS 199	SET 6 PEZZI, ADATTATORI

CARATTERISTICHE

- cromati satinati
- peso: 620 g

CONTENUTO

- 1/4" F X 3/8" M, coppia massima 60 Nm
- 3/8" F X 1/4" M, coppia massima 60 Nm
- 3/8" F X 1/2" M, coppia massima 200 Nm
- 1/2" F X 3/8" M, coppia massima 200 Nm
- 1/2" F X 3/4" M, coppia massima 500 Nm
- 3/4" F X 1/2" M, coppia massima 500 Nm

BGS articolo	DESCRIZIONE
BGS 199-LEER	CASSETTA VUOTA

RACCORDI DI RIDUZIONE MAGNETICI A SCOMPARSA IDEALI PER CHIAVI DINAMOMETRICHE E SPAZI RIDOTTI
attacco: 1/4"-3/8"-1/2"

FEWMEC articolo	FEMMINA	MASCHIO	
1434-1/4	1/4"	3/8"	1
1434-3/8	3/8"	1/2"	1
1434-1/2	1/2"	3/4"	1

RACCORDI DI RIDUZIONE MAGNETICI "POWER IMPACT" A SCOMPARSA - SPAZI RIDOTTI



FEWMEC articolo	F	M	L mm	
698-00	1/4"	3/8"	17	1
698-0	1/4"	1/2"	22	1
698-1	3/8"	1/2"	22	1
698-11	1/2"	3/4"	30	1
698-8	3/4"	1"	35	1
698-13	1"	1 1/2"	50	1
698-15	1 1/2"	2 1/2"	60	1

CASSETTA 4 PZ. CONTENUTO:

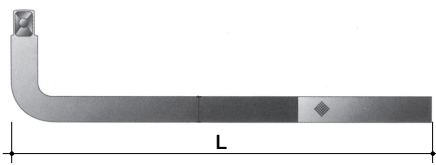
698	1 PZ. 698-00	1
	1 PZ. 698-1	
	1 PZ. 698-11	
	1 PZ. 698-8	

QUADRO MASCHIO AD ANGOLO "POWER IMPACT" BRUNITO

Attacco: 3/4"

		L mm	
articolo 764050	3/4"	450	1



SFERA

3/4"

PRO+



 articolo

DESCRIZIONE

BGS 263-1

ADATTATORE SCORREVOLE PER BARRE ATT. 3/4"
CARATTERISTICHE



- cromata, satinata
- per impiego con prolunghe
- peso: 270 g



3/4"



LEVA CON QUADRO SCORREVOLE CROMATA

Attacco: 3/4"

		L mm	
articolo BGS 263	3/4"	450	1

LEVA CON QUADRO SCORREVOLE "POWER IMPACT" BRUNITA

Attacco: 3/4"

		L mm	
articolo 754050	3/4"	510	1



3/4" ESAGONO

PRO+

 articolo

DESCRIZIONE

BGS 1457

CHIAVE A CROCE PER RUOTE DI AUTOCARRI
CARATTERISTICHE

- esagono 24, 27, 32 mm, quadro maschio 3/4"
- finitura cromata
- con estremità lucidate
- lunghezza braccio 70 cm
- coppia massima:
 - 24 mm (450 Nm)
 - 27 mm (590 Nm)
 - 32 mm (880 Nm)
 - 3/4" (890 Nm)
- peso: 4,6 kg



3/4" ESAGONO

PRO+

 articolo

DESCRIZIONE

BGS 1458

CHIAVE A CROCE PER RUOTE DI AUTOCARRI, RIPIEGABILE, GIUNTO ARTICOLATO
CARATTERISTICHE

- esagono 24, 27, 32 mm, quadro maschio 3/4"
- lunghezza braccio circa 600 cm
- maggiore coppia grazie al giunto regolabile
- peso: 3,4 kg



3/4"

PRO+



 articolo

DESCRIZIONE

BGS 231

CHIAVE A CRICCHETTO REVERSIBILE, ATT. 3/4" LUNGHEZZA 550 MM
CARATTERISTICHE

- con impugnatura zigrinata
- lunghezza 500 mm
- peso: 2,1 kg



BGS 232-REPAIR



3/4"

PRO+



 articolo

DESCRIZIONE

BGS 232

CHIAVE A CRICCHETTO REVERSIBILE, CON PULSANTE DI SGANCIO RAPIDO, EXTRA LUNGA
CARATTERISTICHE

- da set BGS 1207
- lunghezza 500 mm
- con pulsante di sgancio rapido
- peso: 2,5 kg

RICAMBI

 articolo

DESCRIZIONE

BGS 232-REPAIR

KIT DI RIPARAZIONE



BGS articolo **BGS 9765**

CV **3/4"** **PRO+**

DESCRIZIONE
CHIAVE A CRICCHETTO REVERSIBILE, ATT. 3/4", LUNGHEZZA 550 MM

- CARATTERISTICHE**
- con pulsante di sgancio rapido
 - lunghezza 550 mm
 - meccanismo a cricchetto con 24 denti
 - peso: 2,6 kg



BGS 213-REPAIR

PRO+ **CV** **3/4"**

DESCRIZIONE
CHIAVE A CRICCHETTO ESTENSIBILE, ATT. 3/4" 600 - 985 MM

- BGS** articolo **BGS 213**
- CARATTERISTICHE**
- in acciaio forgiato
 - con manico extra largo
 - coppia max: 1400 Nm
 - **lunghezza regolabile** in 8 step: 600 - 655 - 710 - 765 - 815 - 875 - 925 - 985 mm
 - peso: 4,4 kg

RICAMBI

DESCRIZIONE
BGS 213-REPAIR KIT DI RIPARAZIONE



BGS 283-1

3/4" **PRO+** **CV**

DESCRIZIONE
IMPUGNATURA SNODATA, ATT. 3/4", LUNGH. 630 MM

- CARATTERISTICHE**
- cromata
 - testa quadro, nera
 - coppia massima 600 Nm
 - peso: 1,6 kg
- RICAMBI**
- | DESCRIZIONE |
|----------------------------------|
| BGS 283-1 KIT RIPARAZIONE |



BGS 74255-1

3/4" **PRO+** **CV** **novità**

DESCRIZIONE
IMPUGNATURA SNODATA, ATT. 3/4", 1000 MM

- BGS** articolo **BGS 74255**
- CARATTERISTICHE**
- alta resistenza
 - testa a cricchetto snodata a 180°
 - attacco quadro 3/4"
 - coppia massima: 600 Nm
 - materiale impugnatura: acciaio al cromo vanadio
 - materiale testa del cricchetto: acciaio al cromo molibdeno
 - finitura: cromata lucida
 - lunghezza: 1000 mm
 - peso 3,3 kg
- RICAMBI**
- | DESCRIZIONE |
|--|
| BGS 74255-1 KIT DI RIPARAZIONE PER ART. BGS 74255 |



3/4" **PRO+** **CV**

CHIAVI APERTE A ZAMPA DI GALLO ATTACCO: 3/4"

articolo	mm	
BGS 1759-38	38	1
BGS 1759-41	41	1
BGS 1759-46	46	1
BGS 1759-50	50	1



1/2" **3/4"** **PRO+**

BGS articolo **BGS 1759**

DESCRIZIONE

SET 8 PEZZI, CHIAVI APERTE A ZAMPA DI GALLO, 33-50 MM, ATT. 1/2" - 3/4"

CARATTERISTICHE

- comprende:
 - chiavi aperte a zampa di gallo:
 - 33, 36 mm, attacco 1/2"
 - 38, 41, 46, 50 mm, attacco 3/4"
 - 1 prolunga att. 1/2" lunghezza 125 mm
 - 1 prolunga att. 3/4" lunghezza 100 mm
- peso: 4,1 kg

3/4"



3/4"



ESAGONO

PRO+

BGS articolo	DESCRIZIONE
BGS 1206	SET 14 PEZZI, BUSSOLE, ATT. 3/4"

CARATTERISTICHE

- forgiate
- 10 bussole esagonali 22-24-27-30-32-36-38-41-46-50 mm
- 1 chiave a cricchetto reversibile 500 mm
- 1 barra scorrevole a T 450 mm
- 2 prolunghe 100 - 200 mm
- finitura cromata satinata
- peso: 12,1 kg

RICAMBI

BGS articolo	DESCRIZIONE
BGS 1206-LEER	CASSETTA VUOTA



3/4"



ESAGONO



CV



BGS articolo	DESCRIZIONE
BGS 15113	SET 20 PEZZI, BUSSOLE ATT. 3/4"

CARATTERISTICHE

- comprende i seguenti utensili con attacco 3/4":
 - cricchetto reversibile, lunghezza 495 mm
 - leva con quadro scorrevole, lunghezza 450 mm
 - 2 prolunghe, lunghezza: 100 e 200 mm
 - 16 bussole esagonali misure: 19 - 21 - 22 - 23 - 24 - 26 - 27 - 30 - 32 - 34 - 36 - 38 - 41 - 46 - 48 - 50 mm
- materiale: cromo vanadio, forgiato, finitura satinata cromata
- in cassetta metallica
- peso: 14,1 kg



3/4"



CV

PRO+



ESAGONO

BGS articolo	DESCRIZIONE
BGS 1207	SET 21 PEZZI, BUSSOLE ESAGONALI, ATT. 3/4"

CARATTERISTICHE

- conforme DIN
- bussole esagonali
- 16 bussole: 19-21-22-23-24-26-27-30-32-34-36-38-41-46-48-50 mm,
- 1 cricchetto reversibile lunghezza 500 mm con pulsante di sgancio rapido, testa finitura nera
- 3 prolunghe: 100 - 200 - 400 mm
- 1 chiave con "T" con quadro scorrevole lunghezza 450 mm
- peso: 14,7 kg

RICAMBI

BGS articolo	DESCRIZIONE
BGS 1207-LEER	CASSETTA VUOTA



3/4"

PRO+



CV

POLIGONALE

BGS articolo	DESCRIZIONE
BGS 1223	SET 21 PEZZI, BUSSOLE POLIGONALI, ATT. 3/4"

CARATTERISTICHE

- contenuto:
 - bussole poligonali: 19 - 21 - 22 - 23 - 24 - 26 - 27 - 29 - 30 - 32 - 35 - 36 - 38 - 41 - 46 - 50 mm
 - 3 prolunghe lunghezza 100, 200 e 410 mm
 - cricchetto reversibile lunghezza 500 mm
 - asta con quadro scorrevole lunghezza 455 mm
- peso: 14,3 kg



3/4"



POLIGONALE



CV

PRO+

BGS articolo	DESCRIZIONE
BGS 1107	SET 21 PEZZI, BUSSOLE ATT. 3/4"

CARATTERISTICHE

- conforme DIN
- bussole poligonali: 7/8", 15/16", 1", 1 1/16", 1 1/8", 1 3/16", 1 1/4", 1 5/16", 1 3/8", 1 7/16", 1 1/2", 1 5/8", 1 3/4", 1 13/16", 1 7/8", 2"
- 1 chiave a cricchetto reversibile 500 mm con pulsante di sgancio rapido, testa con finitura nera
- 3 barre di prolunga 100 - 200 - 400 mm
- 1 barra scorrevole a T 450 mm
- peso: 15,1 kg



3/4"



ESAGONO



BGS articolo	DESCRIZIONE
BGS 1202	SET 20 PEZZI, BUSSOLE ATT. 3/4"

CARATTERISTICHE

- forgiate
- 16 bussole con esagono: 19-21-22-23-24-26-27-30-32-34-36-38-41-46-48-50 mm
- 1 chiave a cricchetto reversibile 500 mm
- 1 barra scorrevole a T 450 mm
- 2 barre di prolunga 100-200 mm
- finitura satinata cromata
- peso: 13,2 kg

RICAMBI

BGS articolo	DESCRIZIONE
BGS 1202-LEER	CASSETTA VUOTA



**LA SOLA CASSETTA DA
29 PEZZI
INDISPENSABILE PER CANTIERI**



3/4"



ESAGONO



CRO
MO

FERMEC

articolo

1992901

DESCRIZIONE

SET 29 PEZZI BUSSOLE A MACCHINA, 19-65 MM, ATT. 3/4"

CARATTERISTICHE

- comprende le seguenti bussole esagonali:
19-20-21-22-23-24-25-26-27-28-29-30-32-33-34-35-36-38-40-41-42-46-50-52-55-58-60-63-65 mm
- con scanalatura e foro per spina
- in cassetta in plastica di dimensioni:
740 x 420 x 125 mm
- peso: totale: 24 kg



BUSSOLE "POWER IMPACT"

attacco: 3/4"
impronta: ESAGONO

FEEMEC articolo	mm	L mm	
199-13	13	45	1
199-14	14	45	1
199-15	15	51	1
199-16	16	51	1
199-17	17	51	1
199-18	18	51	1
199-19	19	51	1
199-20	20	51	1
199-21	21	51	1
199-22	22	51	1
199-23	23	51	1
199-24	24	51	1
199-25	25	51	1
199-26	26	51	1
199-27	27	57	1
199-28	28	57	1
199-29	29	57	1
199-30	30	57	1
199-31	31	57	1
199-32	32	57	1
199-33	33	57	1
199-34	34	57	1
199-35	35	57	1
199-36	36	57	1
199-37	37	57	1
199-38	38	58	1
199-39	39	58	1
199-40	40	58	1
199-41	41	58	1
199-42	42	58	1
199-43	43	63	1
199-44	44	63	1
199-45	45	63	1
199-46	46	63	1
199-47	47	63	1
199-48	48	67	1
199-49	49	67	1
199-50	50	67	1
199-52	52	70	1
199-54	54	71	1
199-55	55	71	1
199-56	56	74	1
199-57	57	74	1
199-58	58	75	1
199-59	59	75	1
199-60	60	75	1
199-61	61	75	1
199-63	63	75	1
199-65	65	78	1
199-67	67	80	1



BUSSOLE "POWER IMPACT"

attacco: 3/4"
impronta: ESAGONO

BGS articolo	mm	L mm	
BGS 5617	17	51	1
BGS 5618	18	51	1
BGS 5619	19	51	1
BGS 5621	21	51	1
BGS 5622	22	51	1
BGS 5624	24	51	1
BGS 5626	26	51	1
BGS 5627	27	57	1
BGS 5630	30	57	1
BGS 5632	32	57	1
BGS 5633	33	57	1
BGS 5634	34	57	1
BGS 5635	35	57	1
BGS 5636	36	57	1
BGS 5638	38	58	1
BGS 5640	40	58	1
BGS 5641	41	58	1
BGS 5646	46	63	1
BGS 5648	48	63	1
BGS 5650	50	67	1
BGS 5655	55	71	1
BGS 5660	60	75	1



CASSETTA METALLICA PEZZI 10

BUSSOLE MACCHINA 3/4"

17 - 19 - 22 - 24 - 27 - 30 - 32 - 36 - 41 - 46 MM

attacco: 3/4"

impronta: ESAGONO

FEEMEC articolo	Descrizione	
199146	CASSETTA METALLICA 10 PEZZI	1



ESAGONO

PRO+

3/4"

BGS
articolo

DESCRIZIONE

BGS 5240

SET 8 PEZZI,
BUSSOLE A
MACCHINA, ATT. 3/4"

CARATTERISTICHE

- per utilizzo a macchina
- con scanalatura e foro per spina
- lunghezza 56 mm
- 22-24-27-28-30-32-36-38 mm
- peso: 3,8 kg



BGS articolo	DESCRIZIONE
BGS 5258	SET 21 PEZZI, BUSSOLE ATT. 3/4"

CARATTERISTICHE

- 1 chiave a T con quadro scorrevole lunghezza: 450 mm
- impugnatura chiave a cricchetto a sgancio rapido antiscivolo, 505 mm
- barre di prolunga lunghezza 105 e 250 mm
- snodo 105 mm
- bussole da 3/4", esagonali, con foro per spina e anello: 19, 21, 22, 23, 24, 26, 27, 29, 32, 35, 36, 38, 41, 46 e 50 mm
- peso: 15,6 kg



BGS articolo	DESCRIZIONE
BGS 5242	SET 17 PEZZI, BUSSOLE IMPACT, 19-55 MM, ATT. 3/4"

CARATTERISTICHE

- con scanalatura e foro per spina
- comprende le seguenti misure (Ø max. esterno x lunghezza):
19 mm (Ø 38 x 51 mm), 21 mm (Ø 40 x 51 mm), 22 mm (Ø 40 x 51 mm), 24 mm (Ø 40 x 51 mm), 27 mm (Ø 40 x 54 mm), 30 mm (Ø 46 x 54 mm), 32 mm (Ø 48 x 57 mm), 33 mm (Ø 50 x 57 mm), 34 mm (Ø 52 x 57 mm), 35 mm (Ø 52 x 57 mm), 36 mm (Ø 54 x 57 mm), 38 mm (Ø 56 x 57 mm), 40 mm (Ø 58 x 57 mm), 41 mm (Ø 60 x 57 mm), 46 mm (Ø 66 x 63 mm), 50 mm (Ø 71 x 68 mm), 55 mm (Ø 77 x 73 mm)
- peso: 10,5 kg



CHIAVI A BUSSOLA A MACCHINA BOCCA ESAGONALE

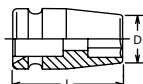

Koken articolo	mm	D mm	L mm	
16400M-16	16	28.8	50	1
16400M-17	17	30	50	1
16400M-18	18	31.3	50	1
16400M-19	19	32.5	50	1
16400M-20	20	33.8	50	1
16400M-21	21	35	50	1
16400M-22	22	36.3	50	1
16400M-23	23	37.5	50	1
16400M-24	24	38.8	50	1
16400M-25	25	40	50	1
16400M-26	26	41.3	50	1
16400M-27	27	42.5	50	1
16400M-28	28	43.8	50	1
16400M-29	29	45	53	1
16400M-30	30	46.3	53	1
16400M-31	31	47.5	53	1
16400M-32	32	48.8	53	1
16400M-33	33	50	55	1
16400M-34	34	51.3	55	1
16400M-35	35	52.5	55	1
16400M-36	36	53.8	55	1
16400M-37	37	55	55	1
16400M-38	38	56.3	57	1
16400M-39	39	57.5	57	1
16400M-40	40	58.8	57	1
16400M-41	41	60	57	1
16400M-42	42	61.3	57	1
16400M-43	43	62.5	62	1
16400M-44	44	63.8	62	1
16400M-45	45	65	62	1
16400M-46	46	66.3	62	1
16400M-47	47	67.5	62	1
16400M-48	48	68.8	62	1
16400M-49	49	70	62	1
16400M-50	50	71.3	62	1
16400M-52	52	73.8	62	1
16400M-54	54	76.3	62	1
16400M-55	55	77.5	62	1
16400M-56	56	78.8	62	1
16400M-57	57	80	65	1
16400M-58	58	81.3	65	1
16400M-59	59	82.5	65	1
16400M-60	60	83.8	65	1
16400M-65	65	90	65	1
16400M-70	70	96.3	70	1

JAPAN PARETI SOTTILI



CHIAVI A BUSSOLA A MACCHINA BOCCA ESAGONALE PARETI SOTTILI

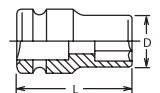

Koken articolo	mm	D mm	L mm	
16401M-16	16	26.8	50	1
16401M-17	17	28	50	1
16401M-18	18	29.3	50	1
16401M-19	19	30.5	50	1
16401M-20	20	31.8	50	1
16401M-21	21	33	50	1
16401M-22	22	34.3	50	1
16401M-23	23	35.5	50	1
16401M-24	24	36.8	50	1
16401M-25	25	38	50	1
16401M-26	26	39.3	50	1
16401M-27	27	40.5	50	1
16401M-28	28	41.8	50	1
16401M-29	29	43	53	1
16401M-30	30	44.3	53	1
16401M-31	31	45.5	53	1
16401M-32	32	46.8	53	1
16401M-33	33	48	55	1
16401M-34	34	49.3	55	1
16401M-35	35	50.5	55	1
16401M-36	36	51.8	55	1
16401M-37	37	53	55	1
16401M-38	38	54.3	57	1
16401M-39	39	55	57	1
16401M-40	40	56.8	57	1
16401M-41	41	58	57	1
16401M-42	42	59.3	57	1
16401M-43	43	60.5	62	1
16401M-44	44	61.8	62	1
16401M-45	45	63	62	1
16401M-46	46	64.3	62	1



Koken articolo	DESCRIZIONE
16201M-00	Set chiavi a bussola 13 Pezzi in cassetta metallica 320 x 110 x h 70 mm
RICAMBI	
BUSSOLE	19, 21, 22, 23, 24, 26, 27, 30, 32, 33, 36, 38, 41
ESAGONO	16400M

IMPACT 3/4"

POLLICI



 3/4"

ESAGONO

BUSSOLE "POWER IMPACT"

attacco: 3/4"

impronta: ESAGONO

FEIMEC articolo	pollici	L mm	
199-9/16	9/16"	50	1
199-5/8	5/8"	50	1
199-11/16	11/16"	50	1
199-3/4	3/4"	50	1
199-13/16	13/16"	50	1
199-7/8	7/8"	50	1
199-15/16	15/16"	50	1
199-1	1"	50	1
199-1-1/8	1-1/8"	50	1
199-1-1/4	1-1/4"	52	1
199-1-5/16	1-5/16"	55	1
199-1-7/16	1-7/16"	55	1
199-1-1/2	1-1/2"	59	1
199-1-9/16	1-9/16"	60	1
199-1-5/8	1-5/8"	60	1
199-1-11/16	1-11/16"	64	1
199-1-3/4	1-3/4"	64	1
199-1-7/8	1-7/8"	67	1
199-1-15/16	1-15/16"	67	1
199-2	2"	67	1
199-2-1/16	2-1/16"	71	1
199-2-3/16	2-3/16"	74	1
199-2-5/16	2-5/16"	75	1
199-2-3/8	2-3/8"	75	1



 ESAGONO



Kokon
 articolo

DESCRIZIONE

16245M

Cassetta metallica 17 Pz.
590 x 127 x h 72 mm

RICAMBI

BUSSOLE	ESAGONO	DESCRIZIONE
16400M		19, 21, 22, 24, 27, 29, 30, 32, 33, 35, 36, 38, 41, 46, 50
ACCESSORI		16760-175  16760-330 

POLLICI

JAPAN

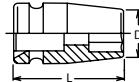

ESAGONO

 CHIAVI A BUSSOLA
 A MACCHINA
 BOCCA ESAGONALE

Kokon articolo	pollici	D mm	L mm	
16400A-5/8	5/8"	28.8	50	1
16400A-11/16	11/16"	30	50	1
16400A-3/4	3/4"	32.5	50	1
16400A-13/16	13/16"	35	50	1
16400A-7/8	7/8"	36.3	50	1
16400A-15/16	15/16"	38.8	50	1
16400A-1	1"	40	50	1
16400A-1-1/16	1-1/16"	42.5	50	1
16400A-1-1/8	1-1/8"	45	53	1
16400A-1-3/16	1-3/16"	46.3	53	1
16400A-1-1/4	1-1/4"	48.8	53	1
16400A-1-5/16	1-5/16"	51.3	55	1
16400A-1-3/8	1-3/8"	52.5	55	1
16400A-1-7/16	1-7/16"	55	55	1
16400A-1-1/2	1-1/2"	56.3	57	1
16400A-1-9/16	1-9/16"	58.8	57	1
16400A-1-5/8	1-5/8"	60	57	1
16400A-1-11/16	1-11/16"	62.5	62	1
16400A-1-3/4	1-3/4"	65	62	1
16400A-1-13/16	1-13/16"	66.3	62	1
16400A-1-7/8	1-7/8"	68.8	62	1
16400A-1-15/16	1-15/16"	70	62	1
16400A-2	2"	71.3	62	1
16400A-2-1/16	2-1/16"	73.8	62	1
16400A-2-1/8	2-1/8"	76.3	62	1
16400A-2-3/16	2-3/16"	77.5	62	1
16400A-2-1/4	2-1/4"	80	65	1
16400A-2-5/16	2-5/16"	81.3	65	1
16400A-2-3/8	2-3/8"	83.8	65	1

POLLICI



Kokon
 articolo

DESCRIZIONE

16201A-00

Set chiavi a bussola
11 Pezzi
in cassetta metallica
290 x 124 x h 69 mm

RICAMBI

BUSSOLE	ESAGONO	DESCRIZIONE
16400A		3/4", 7/8", 15/16", 1", 1.1/16", 1.1/8", 1.1/4", 1.5/16", 1.3/8", 1.7/16", 1.1/2"



 3/4"

POLIGONALE

POLIGONALI

attacco: 3/4"

impronta: POLIGONALE

FEIMEC articolo	mm	L mm	
199-17 DSKT	17	45	1
199-18 DSKT	18	45	1
199-19 DSKT	19	45	1
199-21 DSKT	21	46	1
199-22 DSKT	22	46	1
199-24 DSKT	24	46	1
199-25 DSKT	25	46	1
199-26 DSKT	26	46	1
199-27 DSKT	27	48	1
199-30 DSKT	30	52	1
199-31 DSKT	31	52	1
199-32 DSKT	32	52	1
199-33 DSKT	33	55	1
199-35 DSKT	35	55	1
199-36 DSKT	36	56	1
199-37 DSKT	37	56	1
199-38 DSKT	38	59	1
199-39 DSKT	39	59	1
199-41 DSKT	41	59	1
199-42 DSKT	42	59	1
199-43 DSKT	43	64	1
199-44 DSKT	44	64	1
199-45 DSKT	45	64	1
199-46 DSKT	46	64	1
199-49 DSKT	49	67	1
199-50 DSKT	50	67	1
199-52 DSKT	52	70	1
199-54 DSKT	54	71	1
199-55 DSKT	55	71	1
199-57 DSKT	57	75	1
199-58 DSKT	58	75	1
199-60 DSKT	60	75	1
199-61 DSKT	61	75	1



CHIAVI A BUSSOLA
A MACCHINA
BOCCA POLIGONALE

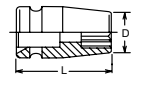

Koken articolo	mm	D mm	L mm	
16405M-17	17	30	50	1
16405M-18	18	31.3	50	1
16405M-19	19	32.5	50	1
16405M-20	20	33.8	50	1
16405M-21	21	35	50	1
16405M-22	22	36.3	50	1
16405M-23	23	37.5	50	1
16405M-24	24	38.8	50	1
16405M-25	25	40	50	1
16405M-26	26	41.3	50	1
16405M-27	27	42.5	50	1
16405M-28	28	43.8	50	1
16405M-29	29	45	53	1
16405M-30	30	46.3	53	1
16405M-32	32	48.8	53	1
16405M-33	33	50	55	1
16405M-34	34	51.3	55	1
16405M-35	35	53	55	1
16405M-36	36	53.8	55	1
16405M-38	38	56.3	57	1
16405M-41	41	60	57	1
16405M-42	42	62.3	57	1
16405M-46	46	66.3	62	1
16405M-50	50	71.3	62	1
16405M-52	52	73.8	62	1
16405M-55	55	77.5	62	1
16405M-60	60	83.8	65	1
16405M-65	65	90	65	1



POLIGONALI
attacco: 3/4"
impronta: POLIGONALE

FERMEC articolo	pollici	L mm	
199-3/4 DSKT	3/4"	45	1
199-13/16 DSKT	13/16"	46	1
199-7/8 DSKT	7/8"	46	1
199-15/16 DSKT	15/16"	46	1
199-1 DSKT	1"	46	1
199-1-1/8 DSKT	1-1/8"	52	1
199-1-1/4 DSKT	1-1/4"	52	1
199-1-5/16 DSKT	1-5/16"	55	1
199-1-7/16 DSKT	1-7/16"	56	1
199-1-9/16 DSKT	1-9/16"	59	1
199-1-3/4 DSKT	1-3/4"	64	1
199-1-7/8 DSKT	1-7/8"	67	1
199-1-15/16 DSKT	1-15/16"	67	1
199-2 DSKT	2"	70	1
199-2-1/16 DSKT	2-1/16"	71	1
199-2-3/16 DSKT	2-3/16"	74	1
199-2-5/16 DSKT	2-5/16"	75	1
199-2-3/8 DSKT	2-3/8"	75	1



CHIAVI A BUSSOLA
A MACCHINA
BOCCA POLIGONALE

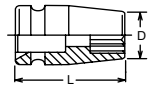

Koken articolo	pollici	D mm	L mm	
16405A-3/4	3/4"	32.5	50	1
16405A-13/16	13/16"	35	50	1
16405A-7/8	7/8"	36.3	50	1
16405A-15/16	15/16"	38.8	50	1
16405A-1	1"	40	50	1
16405A-1-1/16	1-1/16"	42.5	50	1
16405A-1-1/8	1-1/8"	45	53	1
16405A-1-3/16	1-3/16"	46.3	53	1
16405A-1-1/4	1-1/4"	48.8	53	1
16405A-1-5/16	1-5/16"	51.3	55	1
16405A-1-3/8	1-3/8"	52.5	55	1
16405A-1-7/16	1-7/16"	55	55	1
16405A-1-1/2	1-1/2"	56.3	57	1
16405A-1-5/8	1-5/8"	60	57	1
16405A-1-11/16	1-11/16"	62.5	62	1
16405A-1-3/4	1-3/4"	65	62	1
16405A-1-7/8	1-7/8"	68.8	62	1
16405A-2	2"	72.5	62	1

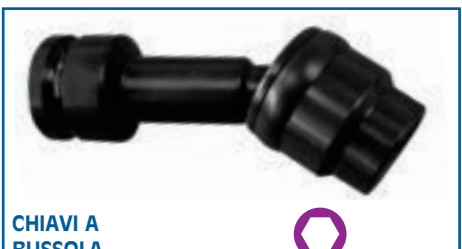

CHIAVI A
BUSSOLA
A MACCHINA
BOCCA
ESAGONALE
TIPO EXTRA
LUNGO SNODATA

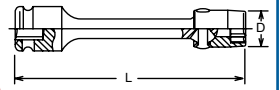

FERMEC articolo	mm	D mm	L mm	
199-17-G-150	17	29	150	1
199-18-G-150	18	32	150	1
199-19-G-150	19	32	150	1
199-21-G-150	21	35	150	1
199-22-G-150	22	38	150	1
199-24-G-150	24	40	150	1
199-27-G-150	27	41	150	1
199-30-G-150	30	44	150	1
199-32-G-150	32	49	150	1
199-34-G-150	34	52	150	1
199-36-G-150	36	52	150	1
199-38-G-150	38	54	150	1
199-41-G-150	41	57	150	1
199-46-G-150	46	67	150	1



CHIAVI A BUSSOLA
A MACCHINA
BOCCA SURFACE DRIVE

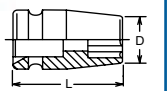

Koken articolo	mm	D mm	L mm	
16410M-16	16	28,8	50	1
16410M-17	17	30	50	1
16410M-18	18	31,3	50	1
16410M-19	19	32,5	50	1
16410M-21	21	35	50	1
16410M-22	22	36,3	50	1
16410M-24	24	38,8	50	1
16410M-27	27	42,5	50	1
16410M-30	30	46,3	53	1
16410M-32	32	48,8	53	1
16410M-33	33	50	55	1
16410M-36	36	53,8	55	1

BUSSOLE SURFACE DRIVE

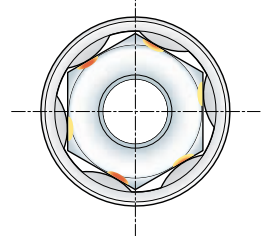

IMPACT 3/4"



JAPAN



CHIAVI A BUSSOLA
A MACCHINA
BOCCA TORX®

Koken articolo		D mm	L mm	
16425-E18	E 18	26.3	50	1
16425-E20	E 20	28.8	50	1
16425-E22	E 22	31.3	50	1
16425-E24	E 24	32.5	50	1
16425-E26	E 26	35	60	1
16425-E28	E 28	36.3	60	1
16425-E30	E 30	38.8	60	1
16425-E32	E 32	41.3	60	1

TORX® (E)	S in mm		
E 4	3,83	E 16	14,71
E 5	4,72	E 18	16,64
E 6	5,69	E 20	18,41
E 7	6,17	E 22	20,24
E 8	7,47	E 24	22,10
E 10	9,37	E 26	23,85
E 11	10,03	E 28	25,65
E 12	11,12	E 30	27,40
E 14	12,85	E 32	29,20



JAPAN



CHIAVI A BUSSOLA
A MACCHINA
BOCCA TORX PLUS

Koken articolo		D mm	L mm	
16425-24EPL	24EPL	32.5	55	1
16425-26EPL	26EPL	35	62	1
16425-28EPL	28EPL	36.3	62	1
16425-30EPL	30EPL	38.8	62	1
16425-32EPL	32EPL	40	62	1

TORX PLUS®	S mm		
E 4	3.70	E 16	14.60
E 5	4.60	E 18	16.50
E 6	5.60	E 20	18.30
E 7	6.10	E 22	20.10
E 8	7.40	E 24	22.00
E 10	9.30	E 26	23.70
E 11	9.90	E 28	25.50
E 12	11.00	E 30	27.30
E 14	12.80	E 32	29.00



QUADRO

QUADRO FEMMINA
attacco: 3/4"
impronta: QUADRA

FEINTEC articolo		D mm	L mm	
199-17 VKT	17	51	1	
199-19 VKT	19	51	1	
199-20 VKT	20	51	1	
199-21 VKT	21	51	1	
199-22 VKT	22	51	1	
199-24 VKT	24	51	1	
199-27 VKT	27	51	1	
199-30 VKT	30	51	1	



JAPAN

QUADRO

CHIAVI A BUSSOLA CON BOCCA QUADRO FEMMINA

Koken articolo		D mm	L mm	
PS 6-17	17	40	53	1
PS 6-19	19	40	53	1
PS 6-20	20	44	55	1
PS 6-21	21	44	57	1

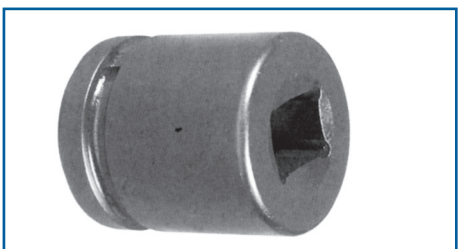

RETTANGOLO

RETTANGOLARI
attacco: 3/4"
impronta: RETTANGOLO

FEINTEC articolo		D mm	L mm	
199-21-28 RVKT	21 x 28	100	1	



ESAGONO

LUNGHE
attacco: 3/4"
impronta: ESAGONO

FEINTEC articolo		D mm	L mm	
199-16 L	16	95	1	
199-17 L	17	95	1	
199-18 L	18	95	1	
199-19 L	19	95	1	
199-20 L	20	95	1	
199-21 L	21	95	1	
199-22 L	22	95	1	
199-23 L	23	95	1	
199-24 L	24	95	1	
199-25 L	25	95	1	
199-26 L	26	95	1	
199-27 L	27	95	1	
199-28 L	28	95	1	
199-29 L	29	95	1	
199-30 L	30	95	1	
199-32 L	32	95	1	
199-33 L	33	95	1	
199-34 L	34	95	1	
199-35 L	35	95	1	
199-36 L	36	95	1	
199-37 L	37	95	1	
199-38 L	38	95	1	
199-39 L	39	95	1	
199-40 L	40	95	1	
199-41 L	41	95	1	
199-42 L	42	95	1	
199-43 L	43	95	1	
199-44 L	44	95	1	
199-45 L	45	95	1	
199-46 L	46	95	1	
199-47 L	47	95	1	
199-48 L	48	95	1	
199-49 L	49	95	1	
199-50 L	50	95	1	
199-52 L	52	95	1	
199-55 L	55	95	1	
199-60 L	60	100	1	
199-65 L	65	105	1	

IMPACT 3/4"



3/4"



ESAGONO

LUNGHE

attacco: 3/4"
impronta: ESAGONO

BGS articolo	mm	L mm	
BGS 5717	17	90	1
BGS 5718	18	90	1
BGS 5719	19	90	1
BGS 5721	21	90	1
BGS 5722	22	90	1
BGS 5724	24	90	1
BGS 5726	26	90	1
BGS 5727	27	90	1
BGS 5730	30	90	1
BGS 5732	32	90	1
BGS 5733	33	90	1
BGS 5734	34	90	1
BGS 5736	36	90	1
BGS 5738	38	90	1
BGS 5741	41	90	1
BGS 5746	46	90	1
BGS 5750	50	90	1
BGS 5755	55	100	1
BGS 5760	60	115	1



ESAGONO

CHIAVI A BUSSOLA
A MACCHINA
BOCCA ESAGONALE
TIPO LUNGO

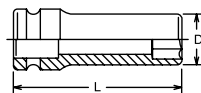

Koken articolo	mm	D mm	L mm	
16300M-14	14	26.3	100	1
16300M-16	16	28.8	100	1
16300M-17	17	30	100	1
16300M-18	18	31.3	100	1
16300M-19	19	32.5	100	1
16300M-20	20	33.8	100	1
16300M-21	21	35	100	1
16300M-22	22	36.3	100	1
16300M-23	23	37.5	100	1
16300M-24	24	38.8	100	1
16300M-25	25	40	100	1
16300M-26	26	41.3	100	1
16300M-27	27	42.5	100	1
16300M-28	28	43.8	100	1
16300M-29	29	45	100	1
16300M-30	30	46.3	100	1
16300M-31	31	47.5	100	1
16300M-32	32	48.8	100	1
16300M-33	33	50	100	1
16300M-34	34	51.3	100	1
16300M-35	35	52.5	100	1
16300M-36	36	53.8	100	1
16300M-37	37	55	100	1
16300M-38	38	56.3	100	1
16300M-40	40	58.8	100	1
16300M-41	41	60	100	1
16300M-42	42	61.3	100	1
16300M-43	43	62.5	100	1
16300M-44	44	63.8	100	1
16300M-46	46	66.3	100	1
16300M-48	48	68.8	100	1
16300M-50	50	71.3	100	1
16300M-55	55	77.5	100	1
16300M-60	60	83.8	100	1



ESAGONO

CHIAVI A BUSSOLA
A MACCHINA
BOCCA ESAGONALE
TIPO LUNGO
PARETI SOTTILI

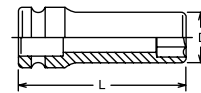

Koken articolo	mm	D mm	L mm	
16301M-16	16	26.8	100	1
16301M-17	17	28	100	1
16301M-18	18	29.3	100	1
16301M-19	19	30.5	100	1
16301M-20	20	31.8	100	1
16301M-21	21	33	100	1
16301M-22	22	34.3	100	1
16301M-23	23	35.5	100	1
16301M-24	24	36.8	100	1
16301M-25	25	38	100	1
16301M-26	26	39.3	100	1
16301M-27	27	40.5	100	1
16301M-28	28	41.8	100	1
16301M-29	29	43	100	1
16301M-30	30	44.3	100	1
16301M-31	31	45.5	100	1
16301M-32	32	46.8	100	1
16301M-33	33	48	100	1
16301M-34	34	49.3	100	1
16301M-35	35	50.5	100	1
16301M-36	36	51.8	100	1
16301M-37	37	53	100	1
16301M-38	38	54.3	100	1
16301M-39	39	55.5	100	1
16301M-40	40	56.8	100	1
16301M-41	41	58	100	1
16301M-42	42	59.3	100	1
16301M-46	46	64.3	100	1
16301M-50	50	69.2	100	1



3/4"



ESAGONO



PRO+

BGS articolo

DESCRIZIONE

BGS 5241

SET 8 PEZZI BUSSOLE
A MACCHINA LUNGHE

CARATTERISTICHE

- brunite
- con scanalatura e foro per spina
- lunghezza 90 mm
- 22-24-27-28-30-32-36-38 mm
- peso: 6,4 kg

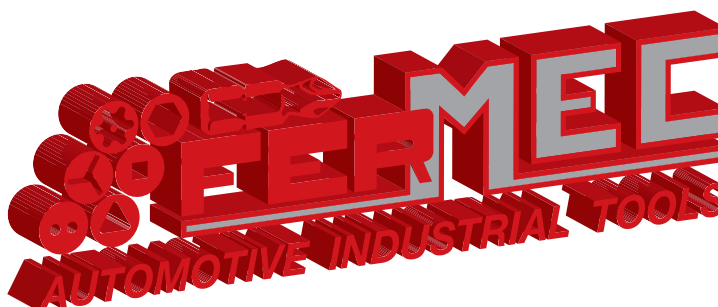

PARETI SOTTILI

SEMI-LUNGA

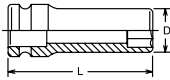

ESAGONO
**CHIAVI A BUSSOLA
A MACCHINA
BOCCA ESAGONALE
TIPO SEMI LUNGO**

JAPAN

Kokon articolo	mm	D mm	L mm	
16301X-17	17	28	75	1
16301X-18	18	29.3	75	1
16301X-19	19	30.5	75	1
16301X-20	20	31.8	75	1
16301X-21	21	33	75	1
16301X-22	22	34.3	75	1
16301X-23	23	35.5	75	1
16301X-24	24	36.8	75	1
16301X-25	25	38	75	1
16301X-26	26	39.3	75	1
16301X-27	27	40.5	75	1
16301X-28	28	41.8	75	1
16301X-29	29	43	75	1
16301X-30	30	44.3	75	1
16301X-31	31	45.5	75	1
16301X-32	32	46.8	75	1
16301X-33	33	48	75	1
16301X-35	35	50.5	75	1
16301X-36	36	51.8	75	1
16301X-37	37	53	75	1
16301X-38	38	54.3	80	1
16301X-40	40	56.8	80	1
16301X-41	41	58	80	1
16301X-46	46	64.3	80	1



SURFACE DRIVE
**CHIAVI A BUSSOLA
A MACCHINA
BOCCA SURFACE
DRIVE**

TIPO LUNGO

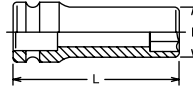

Kokon articolo	mm	D mm	L mm	
16310M-15 <small>novità</small>	15	27,5	100	1
16310M-16	16	28,8	100	1
16310M-17	17	30	100	1
16310M-18	18	31,3	100	1
16310M-19	19	32,5	100	1
16310M-21	21	35	100	1
16310M-22	22	36,3	100	1
16310M-24	24	38,8	100	1
16310M-27	27	42,5	100	1
16310M-30	30	46,3	100	1
16310M-32	32	48,8	100	1
16310M-33	33	50	100	1
16310M-36	36	53,8	100	1

JAPAN

POLLICI

JAPAN

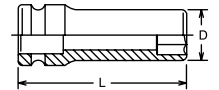

ESAGONO
**CHIAVI A BUSSOLA
A MACCHINA
BOCCA ESAGONALE
TIPO LUNGO**

Kokon articolo	pollici	D mm	L mm	
16300A-3/4	3/4"	32.5	100	1
16300A-13/16	13/16"	35	100	1
16300A-7/8	7/8"	36.3	100	1
16300A-15/16	15/16"	38.8	100	1
16300A-1	1"	40	100	1
16300A-1-1/16	1-1/16"	42.5	100	1
16300A-1-1/8	1-1/8"	45	100	1
16300A-1-3/16	1-3/16"	46.3	100	1
16300A-1-1/4	1-1/4"	48.8	100	1
16300A-1-5/16	1-5/16"	51.3	100	1
16300A-1-3/8	1-3/8"	52.5	100	1
16300A-1-7/16	1-7/16"	55	100	1
16300A-1-1/2	1-1/2"	56.3	100	1
16300A-1-9/16	1-9/16"	58.8	100	1
16300A-1-5/8	1-5/8"	60	100	1
16300A-1-11/16	1-11/16"	62.5	100	1
16300A-1-3/4	1-3/4"	65	100	1
16300A-1-13/16	1-13/16"	66.3	100	1
16300A-1-7/8	1-7/8"	68.8	100	1
16300A-2	2"	72.5	100	1

POLLICI



 3/4"



ESAGONO

LUNGHE

attacco: 3/4"

impronta: ESAGONO

FERMEC articolo	pollici	L mm	
199-3/4 L	3/4"	90	1
199-13/16 L	13/16"	90	1
199-7/8 L	7/8"	90	1
199-15/16 L	15/16"	90	1
199-1 L	1"	90	1
199-1-1/8 L	1-1/8"	90	1
199-1-1/4 L	1-1/4"	90	1
199-1-5/16 L	1-5/16"	90	1
199-1-7/16 L	1-7/16"	90	1
199-1-9/16 L	1-9/16"	90	1
199-1-11/16 L	1-11/16"	90	1
199-1-3/4 L	1-3/4"	90	1
199-1-7/8 L	1-7/8"	90	1
199-1-15/16 L	1-15/16"	90	1
199-2 L	2"	90	1



BGS articolo	DESCRIZIONE
BGS 5250	SET 6 PEZZI, BUSSOLE A MACCHINA TIPO LUNGO, ATT. 3/4"

CARATTERISTICHE

- per utilizzo a macchina
- lunghezza 110 mm
- comprende:
 - Torx femmina E18-E20-E22-E24
 - poligonale 17 e 19 mm
- per viti testata cilindri di autocarri, ad es.:
 - MB 300-400-420-500-900;
 - MAN M 2000, F90, F8, D20, D25, D28
- peso: 3,3 kg

RICAMBI

BGS articolo	DESCRIZIONE
BGS 5345	BUSSOLA POLIGONALE, ATT. 3/4", 17 MM
BGS 5346	BUSSOLA POLIGONALE, ATT. 3/4", 19 MM
BGS 5347	BUSSOLA TORX, ATT. 3/4", E18
BGS 5348	BUSSOLA TORX, ATT. 3/4", E20
BGS 5349	BUSSOLA TORX, ATT. 3/4", TORX E24

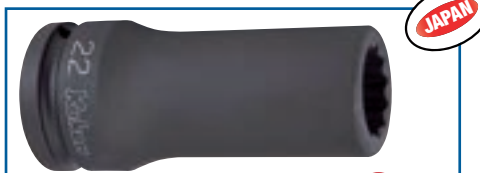

POLIGONALE

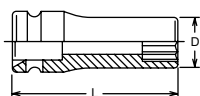

CHIAVI A BUSSOLA A MACCHINA BOCCA POLIGONALE TIPO LUNGO

Koken articolo	mm	D mm	L mm	
16305M-14	14	26.3	100	1
16305M-16	16	28.8	100	1
16305M-17	17	30	100	1
16305M-18	18	31.3	100	1
16305M-19	19	32.5	100	1
16305M-21	21	35	100	1
16305M-22	22	36.3	100	1
16305M-23	23	37.5	100	1
16305M-24	24	38.8	100	1
16305M-26	26	41.3	100	1
16305M-27	27	42.5	100	1
16305M-28	28	43.8	100	1
16305M-29	29	45	100	1
16305M-30	30	46.3	100	1
16305M-32	32	48.8	100	1
16305M-33	33	50	100	1
16305M-34	34	51.3	100	1
16305M-35	35	52.5	100	1
16305M-36	36	53.8	100	1
16305M-38	38	56.3	100	1
16305M-41	41	60	100	1
16305M-46	46	66.3	100	1
16305M-50	50	71.3	100	1



TORX®

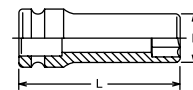

CHIAVI A BUSSOLA A MACCHINA BOCCA TORX® TIPO LUNGO

Koken articolo		D mm	L mm	
16325-E18	E 18	26.3	100	1
16325-E20	E 20	28.8	100	1
16325-E22	E 22	31.3	100	1
16325-E24	E 24	32.5	100	1
16325-E26	E 26	35	100	1
16325-E28	E 28	36.3	100	1
16325-E30	E 30	38.8	100	1
16325-E32	E 32	41.3	100	1
199-26 GTXL	E 26		110	1
199-28 GTXL	E 28		110	1
199-30 GTXL	E 30		110	1
199-32 GTXL	E 32		110	1



CHIAVI A BUSSOLA A MACCHINA ECONOMICHE BOCCA TORX® TIPO LUNGO

TORX®

BGS articolo		L mm	
BGS 5347	E 18	110	1
BGS 5348	E 20	110	1
BGS 5349	E 24	110	1
BGS 5250-E26	E 26	110	1
BGS 5250-E28	E 28	110	1
BGS 5250-E30	E 30	110	1
BGS 5250-E32	E 32	110	1

TORX®	S mm	S mm	
E 4	3.70	E 16	14.60
E 5	4.60	E 18	16.50
E 6	5.60	E 20	18.30
E 7	6.10	E 22	20.10
E 8	7.40	E 24	22.00
E 10	9.30	E 26	23.70
E 11	9.90	E 28	25.50
E 12	11.00	E 30	27.30
E 14	12.80	E 32	29.00



IMPACT 3/4"

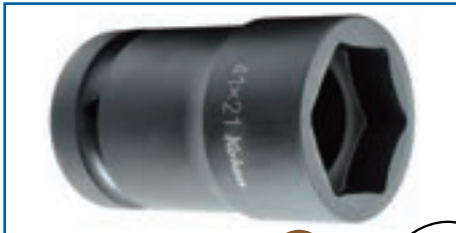

JAPAN

ESAGONO QUADRO

BUSSOLE SPECIALI PER DADI RUOTE POSTERIORI

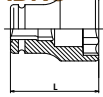

Koken articolo	mm	mm	L mm	
PW6 - 32 X 17	32	17	75	1
PW6 - 35 X 17	35	17	75	1
PW6 - 38 X 20	38	20	75	1
PW6 - 41 X 19	41	19	80	1
PW6 - 41 X 20	41	20	80	1
PW6 - 41 X 21	41	21	80	1

MISURE		VEICOLI	
32	17	TOYOTA	(~2t)
35	17	NISSAN MITSUBISHI MAZDA ISUZU	(~3t) (~1t) (~2t) (~3.5t)
38	20	MITSUBISHI	(2~3.5t)
41	19	MAZDA	(3~4t)
41	20	TOYOTA DAIHATSU HINO	(2t~) (2~3.5t) (2~3.5t)
41	21	NISSAN MITSUBISHI ISUZU HINO	(4t~) (2t~) (4t~) (4t~)

Serraggio/allentamento del dado esterno

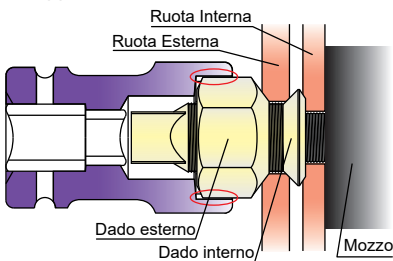

Serraggio/allentamento del dado interno

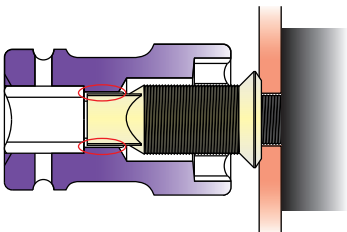

TRUCK

JAPAN



ISUZU

ESAGONO QUADRO

CHIAVI A BUSSOLA A MACCHINA PER AUTOTRENO

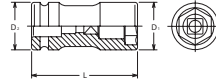

Koken articolo	mm	mm	L mm	
16316M-35X17	35	17	90	1
16316M-38X20	38	20	100	1
16316M-41X19	41	19	100	1
16316M-41X21	41	21	100	1
16316A-1-1/2X13/16	1-1/2"	13/16	100	1

POLLICI



JAPAN

VUOTE

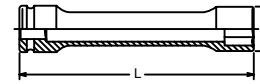

CHIAVI A BUSSOLA EXTRA LUNGHE VUOTE

Koken articolo	mm	D mm	L mm	
16102M-270-24	24	38.8	270	1
16102M-270-27	27	42.5	270	1
16102M-270-30	30	46.3	270	1
16102M-270-32	32	48.8	270	1
16102M-270-33	33	50	270	1
16102M-270-36	36	53.8	270	1
16102M-270-38	38	56.3	270	1
16102M-270-41	41	60	270	1
16102M-270-46	46	FEARLESS	270	1
16102M-270-50	50	FEARLESS	270	1
16102M-400-24	24	38.8	400	1
16102M-400-27	27	42.5	400	1
16102M-400-30	30	46.3	400	1
16102M-400-32	32	48.8	400	1
16102M-400-33	33	50	400	1
16102M-400-36	36	53.8	400	1

BARRE DI TORSIONE

JAPAN

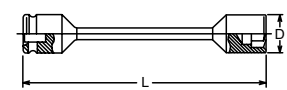

BARRE DI TORSIONE BOCCA ESAGONALE

Koken articolo	mm	Nm	D mm	L mm	
16101M-24 X 180 NM	24	180	38.8	235	1
16101M-27 X 450 NM	27	450	42.5	280	1
16101M-32 X 600 NM	32	600	48.8	280	1
16101M-33 X 600 NM	33	600	50	280	1

Non utilizzare la barra di torsione per svitare i dadi, ma solo per avvitarli.

Per sicurezza, controllare sempre il serraggio con chiave dinamometrica.

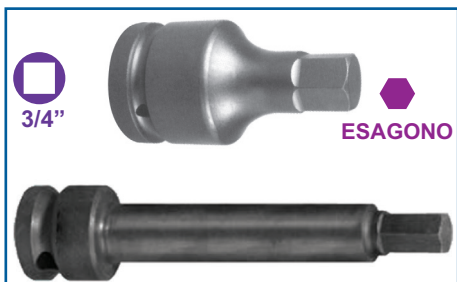

BUSSOLE ESAGONALI MASCHIO BRUNITE CON FORO NEL QUADRO PER SPINA E ANELLO

attacco: 3/4"

impronta: ESAGONO BRUGOLA

articolo	mm	L mm	
182 - 3/4" - 10	10	60	1
182 - 3/4" - 12	12	60	1
182 - 3/4" - 13	13	60	1
182 - 3/4" - 14	14	60	1
182 - 3/4" - 15	15	60	1
182 - 3/4" - 16	16	60	1
182 - 3/4" - 17	17	60	1
182 - 3/4" - 19	19	65	1
182 - 3/4" - 21	21	70	1
182 - 3/4" - 22	22	70	1
182 - 3/4" - 23	23	70	1
182 - 3/4" - 24	24	70	1
1182 - 3/4" - 10	10	100	1
1182 - 3/4" - 12	12	100	1
1182 - 3/4" - 14	14	100	1
1182 - 3/4" - 17	17	100	1
1182 - 3/4" - 19	19	100	1
1182 - 3/4" - 22	22	100	1
1182 - 3/4" - 24	24	100	1
1182 - 3/4" - 27	27	100	1
1182 - 3/4" - 30	30	100	1
1182 - 3/4" - 32	32	100	1
3182 - 3/4" - 10	10	150	1
3182 - 3/4" - 12	12	150	1
3182 - 3/4" - 14	14	150	1
3182 - 3/4" - 17	17	150	1
3182 - 3/4" - 19	19	150	1
3182 - 3/4" - 22	22	150	1
3182 - 3/4" - 24	24	150	1



BUSSOLE ESAGONALI MASCHIO BRUNITE CON FORO NEL QUADRO PER SPINA E ANELLO

articolo	mm	L mm	
BGS 5054-12	12	55	1
BGS 5054-14	14	55	1
BGS 5054-17	17	55	1
BGS 5054-19	19	55	1
BGS 5054-21	21	55	1
BGS 5054-22	22	55	1
BGS 5054-23	23	55	1
BGS 5054-24	24	55	1
BGS 6185-H14	14	100	1
BGS 6185-H17	17	100	1
BGS 6185-H19	19	100	1
BGS 6185-H21	21	100	1
BGS 6185-H22	22	100	1
BGS 6185-H24	24	100	1

CARATTERISTICHE

- adatto per uso con avvitatori a percussione
- bussole con foro per spina e anello
- impronte: Esagonale
- attacco quadro: 3/4"
- materiale: acciaio al cromo molibdeno



CHIAVI A BUSSOLA MASCHIO ESAGONALE INTEGRALE

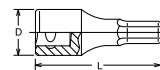

articolo	mm	D mm	L mm	
6012M-12	12	35	75	1
6012M-14	14	35	75	1
6012M-15	15	35	75	1
6012M-16	16	35	75	1
6012M-17	17	35	75	1
6012M-18	18	35	75	1
6012M-19	19	35	75	1
6012M-20	20	37.9	75	1
6012M-21	21	37.9	75	1
6012M-22	22	37.9	75	1
6012M-24	24	37.9	75	1
6012M-27	27	37.9	75	1
6012M-30	30	38	75	1
6012M-32	32	38	75	1
6012M-36	36	42	75	1

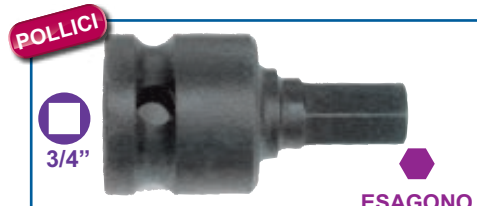

BUSSOLE ESAGONALI MASCHIO BRUNITE CON FORO NEL QUADRO PER SPINA E ANELLO - MISURE IN POLLICI

attacco: 3/4"

impronta: ESAGONO BRUGOLA

articolo	pollici	L mm	
182 W-3/4"-3/8"	3/8"	67	1
182 W-3/4"-7/16"	7/16"	67	1
182 W-3/4"-1/2"	1/2"	67	1
182 W-3/4"-9/16"	9/16"	67	1
182 W-3/4"-5/8"	5/8"	67	1
182 W-3/4"-3/4"	3/4"	67	1
182 W-3/4"-7/8"	7/8"	71	1
182 W-3/4"-1"	1"	71	1
841012	3/8"	100	1
841014	7/16"	100	1
841016	1/2"	100	1
841018	9/16"	100	1
841020	5/8"	100	1
841024	3/4"	100	1
841026	13/16"	100	1
841028	7/8"	100	1
841100	1"	100	1





ESAGONO

FEIMEC articolo	DESCRIZIONE
541061	SET 6 PEZZI, BUSSOLE IMPACT, ESAGONO MASCHIO, ATT. 3/4"

CARATTERISTICHE

- lunghezza 100 mm
- atta quadro femmina 3/4"
- misure: 12-14-17-19-22-24 mm
- in cassetta



novità



3/4" ESAGONO TORX® PRO+

BGS articolo	DESCRIZIONE
BGS 6185	SET 22 PEZZI, CHIAVI A BUSSOLA A MACCHINA MASCHIO, ATT. 3/4", ESAGONALI E TORX

CARATTERISTICHE

- adatto per uso con avvitatori a percussione
- bussole con foro per spina e anello
- in cassetta in plastica
- con modulo portautensili in schiuma ad alta resistenza
- impronte: Esagonale e Torx
- attacco quadro: 3/4"
- materiale: acciaio al cromo molibdeno
- comprende:
 - bussole, lunghezza 55 mm, att. 3/4", Esagonali: 14 mm (BGS 5054-14), 17 mm (BGS 5054-17), 19 mm (BGS 5054-19), 21 mm (BGS 5054-21), 22 mm (BGS 5054-22), 24 mm (BGS 5054-24)
 - bussole, lunghezza 100 mm, att. 3/4", Esagonali: 14 mm (BGS 6185-H14), 17 mm (BGS 6185-H17), 19 mm (BGS 6185-H19), 21 mm (BGS 6185-H21), 22 mm (BGS 6185-H22), 24 mm (BGS 6185-H24)
 - bussole, lunghezza 60 mm, att. 3/4", Torx: TX60 (BGS 5560), TX70 (BGS 5570), TX80 (BGS 5580), TX90 (BGS 5590), TX100 (BGS 5600)
 - bussole, lunghezza 100 mm, att. 3/4", Torx: TX60 (BGS 6185-T60), TX70 (BGS 6185-T70), TX80 (BGS 6185-T80), TX90 (BGS 6185-T90), TX100 (BGS 6185-T100)
- peso: 11,2 kg

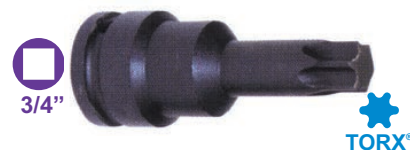

BUSSOLE TORX® MASCHIO BRUNITE CON FORO NEL QUADRO PER SPINA E ANELLO

attacco: 3/4"
impronta: TX

FEIMEC articolo	Impronta	L mm	Box
716080	TX 80	60	1
716090	TX 90	60	1
716100	TX 100	60	1
742050	TX 50	100	1
742055	TX 55	100	1
742060	TX 60	100	1
742070	TX 70	100	1
742080	TX 80	100	1
742090	TX 90	100	1
742100	TX 100	100	1

TORX®	S mm	S mm	
T 6	1.70	T 40	6.70
T 7	2.00	T 45	7.90
T 8	2.30	T 50	8.90
T 9	2.50	T 55	11.30
T 10	2.70	T 60	13.30
T 15	3.30	T 70	15.60
T 20	3.90	T 80	17.60
T 25	4.50	T 90	20.00
T 27	5.00	T 100	22.20
T 30	5.60		



BUSSOLE TORX® MASCHIO BRUNITE CON FORO NEL QUADRO PER SPINA E ANELLO

articolo	TORX	L mm	
BG5 5545	TX 45	60	1
BG5 5550	TX 50	60	1
BG5 5555	TX 55	60	1
BG5 5560	TX 60	60	1
BG5 5565	TX 65	60	1
BG5 5570	TX 70	60	1
BG5 5580	TX 80	60	1
BG5 5590	TX 90	60	1
BG5 5600	TX 100	60	1
BG5 6185-T60	TX 60	100	1
BG5 6185-T70	TX 70	100	1
BG5 6185-T80	TX 80	100	1
BG5 6185-T90	TX 90	100	1
BG5 6185-T100	TX 100	100	1

- CARATTERISTICHE**
- adatto per uso con avvitatori a percussione
 - bussole con foro per spina e anello
 - impronte: TORX
 - attacco quadro: 3/4"
 - materiale: acciaio al cromo molibdeno



SET 6 PEZZI, BUSSOLE IMPACT TORX, ATT. 3/4"

articolo	DESCRIZIONE
BG5 5055	SET 6 PEZZI, BUSSOLE IMPACT TORX, ATT. 3/4"

- CARATTERISTICHE**
- comprende le seguenti chiavi a bussola: TX55 - TX60 - TX70 - TX80 - TX90 - TX100
 - lunghezza: 60 mm
 - materiale: cromo molibdeno, forgiato
 - peso: 2,0 kg



articolo	ESAGONO	L mm
BG5 5054-M16	M 16	55
BG5 5054-M18	M 18	55
BG5 5054-M24	M 24	60

- CARATTERISTICHE**
- per utilizzo a macchina
 - lunghezza 55 mm
 - con scanalatura e foro per spina



SET 9 PEZZI, BUSSOLE IMPACT ESAGONALI E XZN, ATT. 3/4"

articolo	DESCRIZIONE
BG5 5054	SET 9 PEZZI, BUSSOLE IMPACT ESAGONALI E XZN, ATT. 3/4"

- CARATTERISTICHE**
- per utilizzo a macchina
 - lunghezza 55 mm
 - bussole esagonali: 14 - 17 - 19 - 21 - 22 - 23 - 24 mm
 - bussole XZN: M16 - M18
 - peso: 3,3 kg



INSERTO CON MASCHIO ESAGONALE

articolo	ESAGONO mm	L mm	
183H-35-3	3	35	1
183H-35-4	4	35	1
183H-35-5	5	35	1
183H-35-6	6	35	1
183H-35-7	7	35	1
183H-35-8	8	35	1
183H-35-9	9	35	1
183H-35-10	10	35	1
183H-35-11	11	35	1
183H-35-12	12	35	1
183H-35-14	14	35	1
183H-35-16	16	35	1
183H-35-17	17	35	1
183H-35-18	18	35	1
183H-35-19	19	35	1
183H-75-3	3	75	1
183H-75-4	4	75	1
183H-75-5	5	75	1
183H-75-6	6	75	1
183H-75-7	7	75	1
183H-75-8	8	75	1
183H-75-10	10	75	1
183H-75-11	11	75	1
183H-75-12	12	75	1
183H-75-14	14	75	1
183H-150-4	4	150	1
183H-150-5	5	150	1
183H-150-6	6	150	1
183H-150-8	8	150	1
183H-150-10	10	150	1
183H-150-12	12	150	1

IMPACT 3/4"

JAPAN

7/16"

ESAGONO

novità

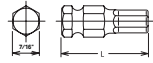
**INSERTO CON MASCHIO ESAGONALE
CON TESTA SFERICA**

attacco: 7/16"

impronta: ESAGONO CON TESTA SFERICA

Koken articolo	mm	L mm	
183H-75-6B	6	75	1
183H-75-8B	8	75	1
183H-75-10B	10	75	1
183H-75-12B	12	75	1
183H-150-6B	6	150	1
183H-150-8B	8	150	1
183H-150-10B	10	150	1
183H-150-12B	12	150	1

JAPAN

7/16"

ESAGONO

POLLICI

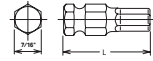
INSERTO CON MASCHIO ESAGONALE

attacco: 7/16"

impronta: ESAGONO

Koken articolo	POLLICI	L mm	
183H-35-3/16	3/16"	35	1
183H-35-7/32	7/32"	35	1
183H-35-1/4	1/4"	35	1
183H-35-5/16	5/16"	35	1
183H-35-3/8	3/8"	35	1
183H-35-7/16	7/16"	35	1
183H-35-1/2	1/2"	35	1

JAPAN

7/16"

TORX®

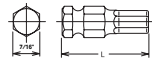
INSERTO CON MASCHIO TORX®

attacco: 7/16"

impronta: TORX®

Koken articolo	TORX®	L mm	
183T-35-T25	TX 25	35	1
183T-35-T30	TX 30	35	1
183T-35-T40	TX 40	35	1
183T-35-T45	TX 45	35	1
183T-35-T50	TX 50	35	1
183T-35-T55	TX 55	35	1
183T-35-T60	TX 60	35	1
183T-75-T25	TX 25	75	1
183T-75-T27	TX 27	75	1
183T-75-T30	TX 30	75	1
183T-75-T40	TX 40	75	1
183T-75-T45	TX 45	75	1
183T-75-T50	TX 50	75	1
183T-75-T55	TX 55	75	1
183T-75-T60	TX 60	75	1
183T-150-T30	TX 30	150	1
183T-150-T40	TX 40	150	1
183T-150-T45	TX 45	150	1
183T-150-T50	TX 50	150	1
183T-150-T55	TX 55	150	1
183T-150-T60	TX 60	150	1

JAPAN

7/16"

TORXplus®

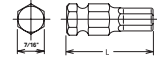
INSERTO CON MASCHIO TORX PLUS®

attacco: 7/16"

impronta: TORX® PLUS

Koken articolo	TORXplus®	L mm	
183T-35-30IP	30 IP	35	1
183T-35-40IP	40 IP	35	1
183T-35-45IP	45 IP	35	1
183T-35-50IP	50 IP	35	1
183T-35-55IP	55 IP	35	1
183T-35-60IP	60 IP	35	1
183T-75-30IP	30 IP	75	1
183T-75-40IP	40 IP	75	1
183T-75-45IP	45 IP	75	1
183T-75-50IP	50 IP	75	1
183T-75-55IP	55 IP	75	1
183T-75-60IP	60 IP	75	1

JAPAN

7/16"

XZN

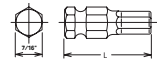
INSERTO CON MASCHIO XZN

attacco: 7/16"

impronta: XZN

Koken articolo	XZN	L mm	
183X-35-M 4	M 4	35	1
183X-35-M 5	M 5	35	1
183X-35-M 6	M 6	35	1
183X-35-M 8	M 8	35	1
183X-35-M 10	M10	35	1
183X-35-M 12	M12	35	1
183X-35-M 14	M14	35	1
183X-75-M 4	M 4	75	1
183X-75-M 5	M 5	75	1
183X-75-M 6	M 6	75	1
183X-75-M 8	M 8	75	1
183X-75-M 10	M10	75	1
183X-75-M 12	M12	75	1
183X-75-M 14	M14	75	1
183X-150-M 5	M 5	150	1
183X-150-M 6	M 6	150	1
183X-150-M 8	M 8	150	1
183X-150-M 10	M10	150	1
183X-150-M 12	M12	150	1
183X-150-M 14	M14	150	1



JAPAN

13134-SC
BUSSOLA PORTA INSERTI CON GRANO DI BLOCCAGGIO DA 7/16"

Koken articolo	D mm	L mm	
16134	44	52	1

RICAMBI	
Koken articolo	DESCRIZIONE
13134-SC	GRANO DI RICAMBIO M8X5, ESAGONO 4 MM



JAPAN

BUSSOLA PORTA INSERTI CON GRANO DI BLOCCAGGIO DA 16 MM

Koken articolo	D mm	L mm	
14106	30	43	1



JAPAN

BUSSOLA PORTA INSERTI CON GRANO DI BLOCCAGGIO DA 16 MM

Koken articolo	D mm	L mm	
16106	32	52	1

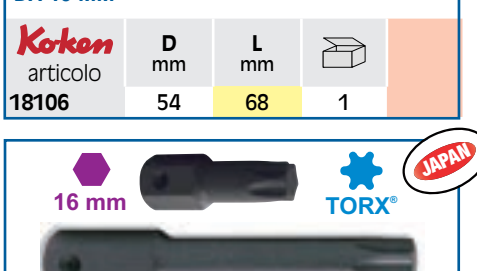

JAPAN

BUSSOLA PORTA INSERTI CON GRANO DI BLOCCAGGIO DA 16 MM

Koken articolo	D mm	L mm	
18106	54	68	1

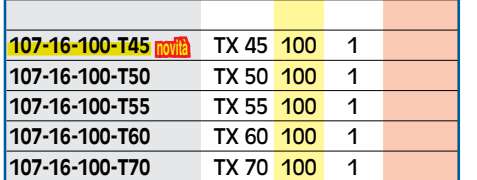

JAPAN

INSERTO CON MASCHIO TORX®

Koken articolo		L mm	
107-16-T45 <i>novità</i>	TX 45	50	1
107-16-T50	TX 50	50	1
107-16-T55	TX 55	50	1
107-16-T60	TX 60	50	1
107-16-T70	TX 70	50	1
107-16-100-T45 <i>novità</i>	TX 45	100	1
107-16-100-T50	TX 50	100	1
107-16-100-T55	TX 55	100	1
107-16-100-T60	TX 60	100	1
107-16-100-T70	TX 70	100	1



JAPAN

INSERTO CON MASCHIO ESAGONALE

Koken articolo		L mm	
107-16-10	10	40	1
107-16-12	12	40	1
107-16-13	13	40	1
107-16-14	14	40	1
107-16-16	16	40	1
107-16-17	17	40	1
107-16-18	18	40	1
107-16-19	19	40	1
107-16-22	22	40	1
107-16-100-10	10	100	1
107-16-100-12	12	100	1
107-16-100-14	14	100	1
107-16-100-17	17	100	1
107-16-100-19	19	100	1
107-16-100-22	22	100	1
107-16-3/8	3/8"	40	1
107-16-1/2	1/2"	40	1
107-16-9/16	9/16"	40	1
107-16-5/8	5/8"	40	1
107-16-3/4	3/4"	40	1



JAPAN

INSERTO CON MASCHIO TORX PLUS®

Koken articolo		L mm	
107-16-55IP	55IP	50	1
107-16-60IP	60IP	50	1
107-16-70IP	70IP	50	1

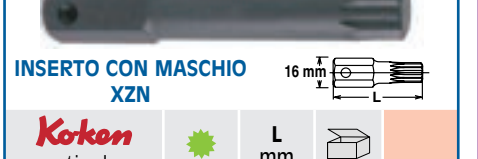

JAPAN

INSERTO CON MASCHIO XZN

Koken articolo		L mm	
107-16-M14	M 14	60	1
107-16-M16	M 16	60	1
107-16-M18	M 18	60	1
107-16-100-M14	M 14	100	1
107-16-100-M16	M 16	100	1
107-16-100-M18	M 18	100	1



ESAGONO TORX®

FEIMEC articolo	DESCRIZIONE
TS 110	TRUCKS SOCKETS SET IN CASSETTA METALLICA

CARATTERISTICHE

- specifico per veicoli industriali e movimento terra
- set 15 pezzi
- chiavi esagonali a L per fissaggio inserti sulle bussole
- inserti attacco esagonale 16 e 22 mm

RICAMBI

FEIMEC articolo	DESCRIZIONE
107-16-12	INS. ESAG. 12 MM, ATT. 16 MM
107-16-14	INS. ESAG. 14 MM, ATT. 16 MM
107-16-17	INS. ESAG. 17 MM, ATT. 16 MM
107-16-19	INS. ESAG. 19 MM, ATT. 16 MM
107-16-22	INS. ESAG. 22 MM, ATT. 16 MM
107-16-T55	INS. TORX TX55, ATT. 16 MM
107-16-T60	INS. TORX TX60, ATT. 16 MM
107-16-T70	INS. TORX TX70, ATT. 16 MM
107-22-T80	INS. TORX TX80, ATT. 22 MM
107-22-T90	INS. TORX TX90, ATT. 22 MM
107-22-T100	INS. TORX TX100, ATT. 22 MM
16106	BUSSOLA PORTA PUNTE QUADRO 3/4", ESAG. 16 MM
18107	BUSSOLA PORTA PUNTE QUADRO 1", ESAG. 22 MM

JAPAN



3/4" 22 mm

16107-SC



BUSSOLA PORTAINSERTI 22 MM

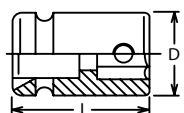

Koken articolo	D mm	L mm	
16107	44	60	1

RICAMBI

Koken articolo	DESCRIZIONE
16107-SC	GRANO DI RICAMBIO M8X14, ESAGONO 4 MM



22 mm ESAGONO

INSERTO CON MASCHIO ESAGONALE PER USO CON BUSSOLE 16107 E 18107

FEIMEC articolo	mm	L mm	
7 RB 014	14	107/140	1
7 RB 017	17	107/140	1
7 RB 019	19	107/140	1
7 RB 022	22	107/140	1
7 RB 024	24	107/140	1



22 mm TORX®

INSERTO CON MASCHIO TORX® PER USO CON BUSSOLE 16107 E 18107

FEIMEC articolo		L mm	
7 LB 060	TX 60	107/140	1
7 LB 070	TX 70	107/140	1
7 LB 080	TX 80	107/140	1
7 LB 090	TX 90	107/140	1
7 LB 100	TX 100	107/140	1

JAPAN



22 mm ESAGONO



INSERTO CON MASCHIO ESAGONALE

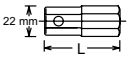

Koken articolo		L mm	
107-22-17	17	50	1
107-22-19	19	50	1
107-22-22	22	50	1
107-22-24	24	50	1
107-22-27	27	50	1
107-22-30	30	50	1
107-22-32	32	55	1

POLLICI

107-22-140-17	17	140	1
107-22-140-19	19	140	1
107-22-140-22	22	140	1
107-22-140-24	24	140	1
107-22-5/8	5/8"	50	1
107-22-3/4	3/4"	50	1
107-22-7/8	7/8"	50	1
107-22-1	1"	50	1
107-22-1-1/4	1-1/4"	55	1

JAPAN



22 mm TORX®



INSERTO CON MASCHIO TORX®



Koken articolo		L mm	
107-22-T70	TX 70	60	1
107-22-T80	TX 80	60	1
107-22-T90	TX 90	60	1
107-22-T100	TX 100	60	1

107-22-140-T70	TX 70	140	1
107-22-140-T80	TX 80	140	1
107-22-140-T90	TX 90	140	1
107-22-140-T100	TX 100	140	1



BSGS articolo	DESCRIZIONE
BGS 5246	SET 16 PEZZI, INSERTI XXL, ATT. 3/4" - 1"

CARATTERISTICHE

- 13 inserti, attacco esagonale 22 mm:
 - Torx: Tx60, Tx70, Tx 80, Tx 90, Tx 100
 - Esagono: 17, 19, 22, 24 mm
 - Torx femmina: E18, E20, E22, E24
- 2 bussole porta inserti da 22 mm, attacco quadro femmina da 3/4" e 1"
- chiavi esagonali a L per fissaggio inserti sulle bussole
- per uso con avvitatori pneumatici
- inserti attacco esagonale 22 mm
- lunghezza inserti 100 mm
- peso: 6,4 kg

RICAMBI

BSGS articolo	DESCRIZIONE
BGS 5246-T60	INSERTO TX 60
BGS 5246-T70	INSERTO TX 70
BGS 5246-T80	INSERTO TX 80
BGS 5246-T90	INSERTO TX 90
BGS 5246-T100	INSERTO TX 100
BGS 5246-E18	INSERTO E-18
BGS 5246-E20	INSERTO E-20
BGS 5246-E22	INSERTO E-22
BGS 5246-E24	INSERTO E-24
BGS 5246-H17	INSERTO ESAG. 17 MM
BGS 5246-H19	INSERTO ESAG. 19 MM
BGS 5246-H22	INSERTO ESAG. 22 MM
BGS 5246-H24	INSERTO ESAG. 24 MM
BGS 5246-2	BUSSOLA ATT. 3/4", PORTAINSERTI 22 MM
BGS 5246-1	BUSSOLA ATT. 1", PORTAINSERTI 22 MM

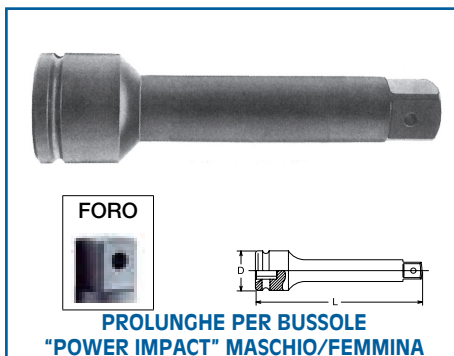

BSGS articolo	FORO	L mm	Box
97-13-75	FORO	75	1
97-13-100	FORO	100	1
97-13-125	FORO	125	1
97-13-175	FORO	175	1
97-14	FORO	250	1
97-15	FORO	330	1
97-15-400	FORO	400	1



Kokon articolo	D mm	FORO	L mm	Box
16760-150	44	FORO	150	1
16760-175	44	FORO	175	1
16760-200	44	FORO	200	1
16760-250	44	FORO	250	1
16760-330	44	FORO	330	1

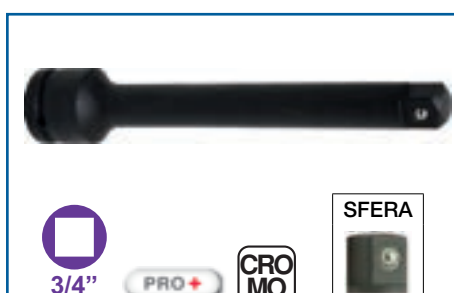

BSGS articolo	SFERA	L mm
BGS 5651	SFERA	100
BGS 5652	SFERA	200
97-14-250 S <i>novità</i>	SFERA	250

CARATTERISTICHE

- per uso con avvitatori pneumatici
- con scanalatura e foro per spina
- con sfera di tenuta nel quadro maschio



PRO+



SFERA

BSGS articolo	DESCRIZIONE
BGS 8840	SET 3 PROLUNGHE IMPACT, ATT. 3/4"

CARATTERISTICHE

- per uso con avvitatori pneumatici
- lunghezze: 100 - 150 - 250 mm
- con scanalatura e foro per spina
- con sfera di tenuta nel quadro maschio
- peso: 2,7 kg



SFERA

3/4" PRO+ CROMO 3/4"

BGS
articolo
BGS 197

DESCRIZIONE
SNODO A MACCHINA

CARATTERISTICHE

- finitura nera
- con sfera di tenuta nel quadro maschio
- peso: 630 g



JAPAN

FORO

SNODO UNIVERSALE

Kokon
articolo
16770

L mm	
106	1



JAPAN

FORO

SNODO UNIVERSALE

Kokon
articolo
16771

L mm	
95	1



3/4" 1/2" JAPAN

SFERA

SGANCIO RAPIDO - Lock & Quick Release

LOCK RELEASE

RACCORDO DI RIDUZIONE QUADRO MASCHIO 1/2" E FEMMINA 3/4" CON SGANCIO RAPIDO PER BUSSOLE "POWER IMPACT"

Kokon
articolo
16644 AL

L mm	
70	1



ADATTATORI DOPPIO QUADRO MASCHIO

FERMEC
articolo

L mm	
20	2841
30	3841
37	4841
53	BGS 9623
68	8841

CARATTERISTICHE

- con doppia sfera

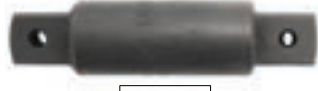

B A

FORO

PROLUNGHE PER BUSSOLE "POWER IMPACT" MASCHIO/MASCHIO

FERMEC
articolo

B	A	L mm	
1/2"	1/2"	50	1
1/2"	1/2"	76	1
1/2"	1/2"	127	1
1/2"	1/2"	254	1
3/4"	3/4"	78	1
3/4"	3/4"	101	1
3/4"	3/4"	127	1
3/4"	3/4"	177	1
1"	1"	76	1
1"	1"	101	1
1"	1"	127	1
1"	1"	152	1
1"	1"	406	1
1 1/2"	1 1/2"	101	1
1 1/2"	1 1/2"	127	1
2-1/2"	2-1/2"	127	1



B A

RIDUZIONI PER BUSSOLE "POWER IMPACT" FEMMINA/FEMMINA

FERMEC
articolo

B	A	L mm	
1/2"	1/2"	33	1
3/4"	1/2"	49	1
3/4"	3/4"	49	1
1"	3/4"	63	1
1"	1"	59	1
1-1/2"	1"	83	1
1 1/2"	1-1/2"	85	1



 AUTOMOTIVE INDUSTRIAL TOOLS



RACCORDI DI RIDUZIONE "POWER IMPACT" MASCHIO/FEMMINA

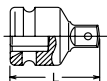

Kokon articolo		F	M	L mm	
12233 A-P	PERNO	1/4"	3/8"	22	1
12233 A-B	SFERA	1/4"	3/8"	22	1
12233 A	FORO	1/4"	3/8"	22	1
13322 A-P	PERNO	3/8"	1/4"	27	1
13322 A-B	SFERA	3/8"	1/4"	27	1
13322 A	FORO	3/8"	1/4"	27	1
13344 A-P	PERNO	3/8"	1/2"	32.5	1
13344 A-B	SFERA	3/8"	1/2"	32.5	1
13344 A	FORO	3/8"	1/2"	32.5	1
14433 A-P	PERNO	1/2"	3/8"	37.5	1
14433 A-B	SFERA	1/2"	3/8"	37.5	1
14433 A	FORO	1/2"	3/8"	37.5	1
14455 A	FORO	1/2"	5/8"	42	1
14466 A	FORO	1/2"	3/4"	44	1
14466 A-B	SFERA	1/2"	3/4"	44	1
14466 A-200 B	SFERA	1/2"	3/4"	200	1
14488 A-B	SFERA	1/2"	1"	58	1
14488 A-200 B	SFERA	1/2"	1"	200	1
15544 A-P	PERNO	5/8"	1/2"	46	1
15544 A	FORO	5/8"	1/2"	46	1
15566 A	FORO	5/8"	3/4"	48	1
16644 A-B	PERNO	3/4"	1/2"	54	1
16644 A-P	SFERA	3/4"	1/2"	54	1
16644 A	FORO	3/4"	1/2"	54	1
16655 A	FORO	3/4"	5/8"	55.5	1
16688 A	FORO	3/4"	1"	62	1
16688 A-250	FORO	3/4"	1"	250	1
16688 A-330	FORO	3/4"	1"	330	1
18866 A	FORO	1"	3/4"	66.5	1
18866 A-200	FORO	1"	3/4"	200	1
18877 A	FORO	1"	1-1/2"	80	1
17788 A	FORO	1-1/2"	1"	98	1
17799 A	FORO	1-1/2"	2-1/2"	115	1
19977 A	FORO	2-1/2"	1-1/2"	145	1
10099 A	FORO	3-1/2"	2-1/2"	182	1



RACCORDI DI RIDUZIONE "POWER IMPACT" MASCHIO/FEMMINA

articolo	F	M	L mm	
96-00	PERNO 1/4"	3/8"	32	1
96-0	PERNO 3/8"	1/4"	35	1
96-1	PERNO 3/8"	1/2"	45	1
96-01	PERNO 1/2"	1/4"	38	1
96-2	PERNO 1/2"	3/8"	45	1
96-3	FORO 5/8"	1/2"	50	1
96-4	PERNO 3/4"	1/2"	56	1
96-8	FORO 3/4"	1"	70	1
96-9	FORO 1"	3/4"	70	1
96-10	PERNO 1"	1/2"	70	1
96-11	FORO 1/2"	3/4"	50	1
96-12	FORO 1 1/2"	1"	115	1
96-13	FORO 1"	1 1/2"	115	1
96-14	FORO 2 1/2"	1 1/2"	115	1
96-15	FORO 1 1/2"	2 1/2"	120	1
96-16	FORO 1 1/4"	1"	140	1
96-17	FORO 1 3/4"	1 1/2"	150	1



RACCORDI DI RIDUZIONE "POWER IMPACT" MASCHIO/FEMMINA CON SFERA DI TENUTA NEL QUADRO MASCHIO

articolo	F	M	L mm	
696-00 S	1/4"	3/8"	26	1
696-0 S	3/8"	1/4"	32	1
696-01 S	1/2"	1/4"	36	1
696-1 S	3/8"	1/2"	36	1
696-2 S	1/2"	3/8"	38	1
696-11 S	1/2"	3/4"	48	1
696-4 S	3/4"	1/2"	56	1
696-8 S	3/4"	1"	63	1
696-9 S	1"	3/4"	75	1

ARTICOLO NON SOGGETTO A GARANZIA



BGS articolo	DESCRIZIONE
BGS 200	SET 6 PEZZI, RIDUZIONI A MACCHINA

CARATTERISTICHE

- rivestimento specifico nero opaco
- peso: 880 g

CONTENUTO

- 1/4" F X 3/8" M, coppia massima 60 Nm
- 3/8" F X 1/4" M, coppia massima 60 Nm
- 3/8" F X 1/2" M, coppia massima 200 Nm
- 1/2" F X 3/8" M, coppia massima 200 Nm
- 1/2" F X 3/4" M, coppia massima 500 Nm
- 3/4" F X 1/2" M, coppia massima 500 Nm

RICAMBI

BGS articolo	DESCRIZIONE
BGS 200-LEER	CASSETTA VUOTA



BGS articolo	DESCRIZIONE
BGS 25140	SET 11 PEZZI, RIDUZIONI E SNODI A MACCHINA

CARATTERISTICHE

- rivestimento specifico nero opaco
- peso: 2,6 kg

CONTENUTO

- 1/4" F x 3/8" M
- 3/8" F x 1/4" M
- 3/8" F x 1/2" M
- 1/2" F x 3/8" M
- 1/2" F x 3/4" M
- 3/4" F x 1/2" M
- 3/4" F x 1" M
- 1" F x 3/4" M
- snodi da 1/4", 3/8", 1/2"

RIDUZIONI IMPACT



SFERA



1/4"-3/8"-1/2"-3/4" 1/4"-3/8"-1/2"-3/4"

**RACCORDI DI RIDUZIONE
CHROM-VANADIUM**

attacco: 1/4" - 3/8" - 1/2" - 3/4"

BGS articolo	FEMMINA MASCHIO		L mm	1
	F	M		
BGS 271	1/4"	3/8"	1	1
BGS 269	3/8"	1/4"	1	1
BGS 280	3/8"	1/2"	1	1
BGS 270	1/2"	3/8"	1	1
BGS 272	1/2"	3/4"	1	1
BGS 274	3/4"	1/2"	1	1

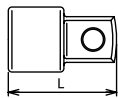

SFERA

**RACCORDO DI
RIDUZIONE
MASCHIO/FEMMINA
CON SFERA DI
TENUTA NEL
QUADRO MASCHIO**

JAPAN

Koken articolo	F M		L mm	1
	F	M		
2233 A	1/4"	3/8"	22	1
3322 A	3/8"	1/4"	24	1
3344 A	3/8"	1/2"	35	1
4433 A-35	1/2"	3/8"	35	1
4433 A-75	1/2"	3/8"	75	1
4433 A-125	1/2"	3/8"	125	1
4433 A-250	1/2"	3/8"	250	1
4433 A-600	1/2"	3/8"	600	1
4466 A	1/2"	3/4"	42	1
6644 A	3/4"	1/2"	47	1
6688 A	3/4"	1"	60	1
8866 A	1"	3/4"	60	1

**RACCORDI DI RIDUZIONE A MANDRINO
CON SGANCIO RAPIDO "POWER IMPACT"**

FEFMEC articolo	F M		L mm	1
	F	M		
691-0 SWF	3/8"	1/4"	55	1
691-1 SWF	3/8"	1/2"	60	1
691-2 SWF	1/2"	3/8"	55	1
691-11 SWF	1/2"	3/4"	75	1
691-4 SWF	3/4"	1/2"	70	1
691-9 SWF	1"	3/4"	90	1
Koken				
14466 AL	1/2"	3/4"	75	1
16644 AL	3/4"	1/2"	70	1

**RACCORDI DI RIDUZIONE MAGNETICI
A SCOMPARSA IDEALI PER CHIAVI
DINAMOMETRICHE E SPAZI RIDOTTI**

attacco: 1/4"-3/8"-1/2"

FEFMEC articolo	F M		L mm	1
	F	M		
1434-1/4	1/4"	3/8"	1	1
1434-3/8	3/8"	1/2"	1	1
1434-1/2	1/2"	3/4"	1	1



SFERA

**RIDUZIONI A SCOMPARSA
CONSFERA NEL QUADRO MASCHIO**

Koken articolo	F M		D mm	L mm	1
	F	M			
2756 Z-3/8	1/4"	3/8"	20.3	21.5	1
2756 Z-1/2	1/4"	1/2"	20.3	26	1
3756 Z-1/2	3/8"	1/2"	28	29	1



**RACCORDI DI RIDUZIONE MAGNETICI
"POWER IMPACT"**
A SCOMPARSA - SPAZI RIDOTTI

FEFMEC articolo	F M		L mm	1
	F	M		
698-00	1/4"	3/8"	17	1
698-0	1/4"	1/2"	22	1
698-1	3/8"	1/2"	22	1
698-11	1/2"	3/4"	30	1
698-8	3/4"	1"	35	1
698-13	1"	1 1/2"	50	1
698-15	1 1/2"	2 1/2"	60	1

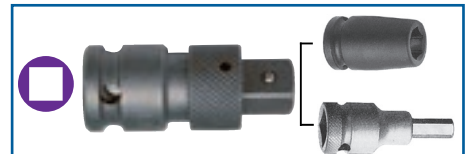
698	CASSETTA 4 PZ. CONTENUTO: 1 PZ. 698-00 1 PZ. 698-1 1 PZ. 698-11 1 PZ. 698-8			1
-----	--	--	--	---

**MANDRINO CON SGANCIO RAPIDO PER
BUSSOLE "POWER IMPACT"**
attacco: Quadro femmina
impronta: DIN 3126, E 11,2 - E 6,35

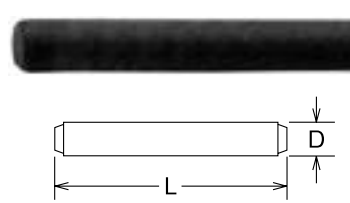
FEFMEC articolo	F M		L mm	1
	F	M		
195-SWF	1/4"	1/4"	41	1
196-SWF	3/8"	3/8"	46	1
97-3-125 SWF	3/8"	3/8"	125	1
197-SWF	1/2"	1/2"	60	1
199-SWF	3/4"	3/4"	78	1
1991-SWF	1"	1"	100	1
Koken				
12222 AL	1/4"	1/4"	35	1
13333 AL	3/8"	3/8"	45	1
14444 AL	1/2"	1/2"	55	1
16666 AL	3/4"	3/4"	75	1
18888 AL	1"	1"	95	1



JAPAN

SPINE ACCIAIO PER BUSSOLE

Koken articolo	Ø	D mm	L mm	1
A 21	1/4"	1.5	10,2	1
A 31	3/8"	2.5	14,5	1
A 32	3/8"	2.5	17,5	1
A 41	1/2"	3.0	20	1
A 42	1/2"	3.0	25	1
A 51	5/8"	4.0	29	1
A 61	3/4"	4.0	35	1
A 62	3/4"	4.0	45	1
A 81	1"	5.0	45	1
A 82	1"	5.0	57	1
A 83	1"	5.0	75	1
A 71	1 1/2"	6.0	75	1
A 72	1 1/2"	6.0	110	1
A 91	2 1/2"	8.0	110	1
A 92	2 1/2"	8.0	155	1
A 01	3 1/2"	13.0	155	1
A 02	3 1/2"	13.0	180	1

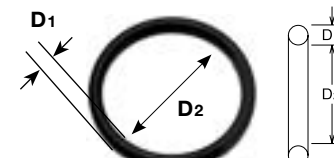

JAPAN

ANELLI DI GOMMA PER BUSSOLE

Koken articolo	Ø	D 1 mm	D 2 mm	1
B 21	1/4"	2.5	9	1
B 31	3/8"	3.5	13	1
B 32	3/8"	3.5	16	1
B 41	1/2"	4	19	1
B 42	1/2"	4	24	1
B 51	5/8"	5	28	1
B 61	3/4"	5	36	1
B 62	3/4"	5	45	1
B 81	1"	7	45	1
B 82	1"	7	57	1
B 83	1"	7	75	1
B 71	1 1/2"	10	75	1
B 72	1 1/2"	10	114	1
B 91	2 1/2"	10.5	114	1
B 92	2 1/2"	10.5	158	1
B 01	3 1/2"	15	158	1
B 02	3 1/2"	15	183	1

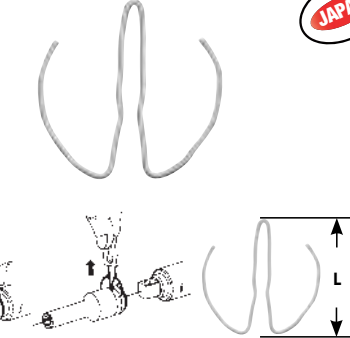

JAPAN

MOLLA DI SICUREZZA PER BUSSOLE

Koken articolo	Ø	L mm	1
C 31	3/8" ≤ 12	18	1
C 32	3/8" > 12	20	1
C 41	1/2" ≤ 14	23	1
C 42	1/2" > 14	26	1
C 61	3/4" ≤ 46	41	1
C 81	1" ≤ 46	50	1
C 82	1" > 46		1
C 83	1" > 70		1
C 71	1 1/2" ≤ 90		1



JAPAN

ESTRATTORE PER MOLLE DI SICUREZZA

Koken articolo	Ø	1
149	3/8" - 1/2"	1
152	3/4" - 1"	1



JAPAN

SET MOLLE DI SICUREZZA PER BUSSOLE

Koken articolo	nr.	149	152
PKC 31	10	149	1
PKC 32	10	149	1
PKC 41	10	149	1
PKC 42	10	149	1
PKC 61	10	152	1
PKC 81	10	152	1

NOTE

MOLLE-SPINE-ANELLI



CHIAVI A BUSSOLA
 GUIDATE ANTI VIBRAZIONI
 BOCCA ESAGONALE

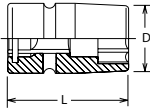

Koken articolo	mm	D mm	L mm	
NV 16400M-17	17	30	65	1
NV 16400M-18	18	31.3	65	1
NV 16400M-19	19	32.5	65	1
NV 16400M-21	21	35	65	1
NV 16400M-22	22	36.3	65	1
NV 16400M-23	23	37.5	65	1
NV 16400M-24	24	38.8	65	1
NV 16400M-26	26	41.3	65	1
NV 16400M-27	27	42.5	65	1
NV 16400M-28	28	43.8	68	1
NV 16400M-29	29	45	68	1
NV 16400M-30	30	46.3	68	1
NV 16400M-32	32	48.8	70	1
NV 16400M-33	33	50	70	1
NV 16400M-34	34	51.3	70	1
NV 16400M-35	35	52.5	70	1
NV 16400M-36	36	53.8	70	1
NV 16400M-38	38	56.3	72	1
NV 16400M-41	41	60	72	1
NV 16400M-46	46	66.3	77	1
NV 16400M-50	50	69	77	1

JAPAN



JAPAN

FORO

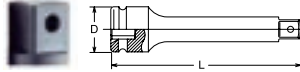

PROLUNGA ANTI VIBRAZIONI

Koken articolo	D mm	L mm	
NV 16760-175	44	175	1
NV 16760-250	44	250	1
NV 16760-330	44	330	1

NOTE

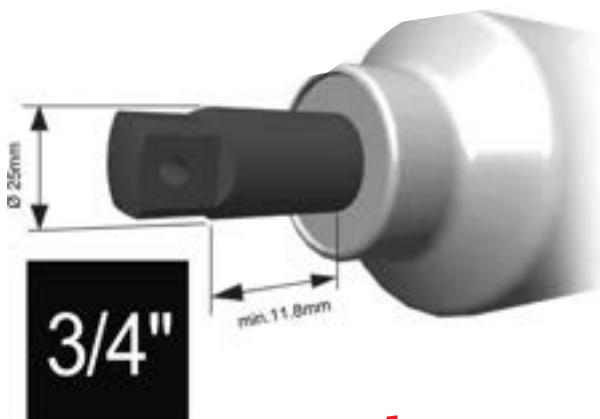

**Guidate
 antivibrazioni**



CASSETTE METALLICHE PORTA-BUSSOLE

articolo	lunghezza (mm)	larghezza (mm)	altezza (mm)	
CASS-2510	240	100	60	1
CASS-2810	280	130	75	1
CASS-3009	300	90	45	1
CASS-3112	310	120	80	1
CASS-3211	320	120	50	1
CASS-4220	420	200	140	1
CASS-6213	610	130	80	1

NOTE

- a richiesta assortimenti di bussole a macchina in cassetta metallica

BGS HANGER-1



BGS HANGER-2



BGS HANGER-3



BGS HANGER-4



BGS HANGER-5



CLIP X ATTACCO QUADRO FEMMINA

articolo	
BGS HANGER-1	1/4"
BGS HANGER-2	3/8"
BGS HANGER-3	1/2"
BGS HANGER-4	3/4"
BGS HANGER-5	1"

CARATTERISTICHE

- clip in plastica con quadro maschio
- ad esempio per esposizione bussole

NOTE

A series of horizontal dashed lines for taking notes.

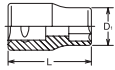

**CHIAVI A BUSSOLA
A MANO BOCCA
ESAGONALE**

Kokon articolo	mm	D mm	L mm	
8400M-24	24	36.5	60	1
8400M-27	27	40.5	60	1
8400M-28	28	41.5	60	1
8400M-29	29	43	60	1
8400M-30	30	44	65	1
8400M-32	32	46.5	65	1
8400M-33	33	48	65	1
8400M-34	34	49	60	1
8400M-35	35	50.5	65	1
8400M-36	36	51.5	65	1
8400M-38	38	54	65	1
8400M-40	40	56.5	65	1
8400M-41	41	58	68	1
8400M-42	42	59	68	1
8400M-46	46	64	72	1
8400M-50	50	69	72	1
8400M-54	54	74	72	1
8400M-55	55	75.5	77	1
8400M-56	56	76.5	60	1
8400M-58	58	79	77	1
8400M-60	60	81.5	82	1
8400M-63	63	85.5	82	1
8400M-65	65	88	86	1
8400M-67	67	90.5	86	1
8400M-68	68	91.5	86	1
8400M-70	70	94	88	1
8400M-71	71	95.5	88	1
8400M-75	75	100.5	90	1
8400M-78	78	104	60	1
8400M-80	80	106.5	95	1
8400M-83	83	110.5	95	1
8400M-85	85	113	95	1
8400M-90	90	119	100	1
8400M-95	95	125.5	100	1
8400M-100	100	131.5	100	1

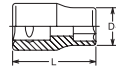
POLLICI

**CHIAVI A BUSSOLA
A MANO BOCCA
ESAGONALE**

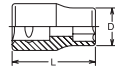
Kokon articolo	pollici	D mm	L mm	
8400A-15/16	15/16"	36.5	60	1
8400A-1-3/16	1-3/16"	44	65	1
8400A-1-1/4	1-1/4"	46.5	65	1
8400A-1-5/16	1-5/16"	48	65	1
8400A-1-3/8	1-3/8"	50.5	65	1
8400A-1-7/16	1-7/16"	53	65	1
8400A-1-1/2	1-1/2"	54	65	1
8400A-1-9/16	1-9/16"	56.5	65	1
8400A-1-5/8	1-5/8"	58	68	1
8400A-1-11/16	1-11/16"	60.5	68	1
8400A-1-3/4	1-3/4"	61.5	68	1
8400A-1-13/16	1-13/16"	64	72	1
8400A-1-7/8	1-7/8"	66.5	72	1
8400A-1-15/16	1-15/16"	68	72	1
8400A-2	2"	70.5	72	1
8400A-2-1/16	2-1/16"	73	72	1
8400A-2-1/8	2-1/8"	74	72	1
8400A-2-3/16	2-3/16"	76.5	77	1
8400A-2-1/4	2-1/4"	78	77	1
8400A-2-5/16	2-5/16"	80.5	77	1
8400A-2-3/8	2-3/8"	81.5	82	1
8400A-2-7/16	2-7/16"	84	82	1
8400A-2-1/2	2-1/2"	86.5	82	1
8400A-2-9/16	2-9/16"	88	86	1
8400A-2-5/8	2-5/8"	90.5	86	1
8400A-2-11/16	2-11/16"	91.5	86	1
8400A-2-3/4	2-3/4"	94	88	1
8400A-2-13/16	2-13/16"	96.5	88	1
8400A-2-7/8	2-7/8"	98	88	1
8400A-2-15/16	2-15/16"	100.5	90	1
8400A-3	3"	103	90	1
8400A-3-1/8	3-1/8"	106.5	95	1
8400A-3-1/4	3-1/4"	110.5	95	1
8400A-3-3/8	3-3/8"	114	95	1
8400A-3-1/2	3-1/2"	119	100	1
8400A-3-3/4	3-3/4"	125.5	100	1



**CHIAVI A BUSSOLA
A MANO BOCCA
POLIGONALE**



Kokon articolo	mm	D mm	L mm	
8405M-24	24	36.5	60	1
8405M-27	27	40.5	60	1
8405M-28	28	41.5	60	1
8405M-29	29	43	60	1
8405M-30	30	44	65	1
8405M-32	32	46.5	65	1
8405M-33	33	48	65	1
8405M-34	34	49	65	1
8405M-35	35	50.5	65	1
8405M-36	36	51.5	65	1
8405M-38	38	54	65	1
8405M-40	40	56.5	65	1
8405M-41	41	58	68	1
8405M-42	42	59	68	1
8405M-46	46	64	72	1
8405M-50	50	69	72	1
8405M-54	54	74	72	1
8405M-55	55	75.5	77	1
8405M-56	56	76.5	77	1
8405M-58	58	79	77	1
8405M-60	60	81.5	82	1
8405M-63	63	85.5	82	1
8405M-65	65	88	86	1
8405M-67	67	90.5	86	1
8405M-68	68	91.5	86	1
8405M-70	70	94	88	1
8405M-71	71	95.5	88	1
8405M-75	75	100.5	90	1
8405M-78	78	104	90	1
8405M-80	80	106.5	95	1
8405M-83	83	110.5	95	1
8405M-85	85	113	95	1
8405M-90	90	119	100	1
8405M-95	95	125.5	100	1
8405M-100	100	131.5	100	1

POLLICI

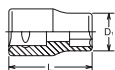

**CHIAVI A BUSSOLA
A MANO BOCCA
POLIGONALE**



Koken articolo	pollici	D mm	L mm	
8405A-15/16	15/16"	36.5	60	1
8405A-1-3/16	1-3/16"	44	65	1
8405A-1-1/4	1-1/4"	46.5	65	1
8405A-1-5/16	1-5/16"	48	65	1
8405A-1-3/8	1-3/8"	50.5	65	1
8405A-1-7/16	1-7/16"	53	65	1
8405A-1-1/2	1-1/2"	54	65	1
8405A-1-9/16	1-9/16"	56.5	65	1
8405A-1-5/8	1-5/8"	58	68	1
8405A-1-11/16	1-11/16"	60.5	68	1
8405A-1-3/4	1-3/4"	61.5	68	1
8405A-1-13/16	1-13/16"	64	72	1
8405A-1-7/8	1-7/8"	66.5	72	1
8405A-1-15/16	1-15/16"	68	72	1
8405A-2	2"	70.5	72	1
8405A-2-1/16	2-1/16"	73	72	1
8405A-2-1/8	2-1/8"	74	72	1
8405A-2-3/16	2-3/16"	76.5	77	1
8405A-2-1/4	2-1/4"	78	77	1
8405A-2-5/16	2-5/16"	80.5	77	1
8405A-2-3/8	2-3/8"	81.5	82	1
8405A-2-7/16	2-7/16"	84	82	1
8405A-2-1/2	2-1/2"	86.5	82	1
8405A-2-9/16	2-9/16"	88	86	1
8405A-2-5/8	2-5/8"	90.5	86	1
8405A-2-11/16	2-11/16"	91.5	86	1
8405A-2-3/4	2-3/4"	94	88	1
8405A-2-13/16	2-13/16"	96.5	88	1
8405A-2-7/8	2-7/8"	98	88	1
8405A-2-15/16	2-15/16"	100.5	90	1
8405A-3	3"	103	90	1
8405A-3-1/8	3-1/8"	106.5	95	1
8405A-3-1/4	3-1/4"	110.5	95	1
8405A-3-3/8	3-3/8"	114	95	1
8405A-3-1/2	3-1/2"	119	100	1
8405A-3-3/4	3-3/4"	125.5	100	1



**CHIAVI A
BUSSOLA
A MANO BOCCA
POLIGONALE
EXTRA LUNGA**

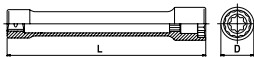

Koken articolo	mm	D mm	L mm	
8102M.400-32	32	48,5	400	1
8102M.400-33	33	49,8	400	1



VUOTE



**CHIAVI A BUSSOLA
EXTRA LUNGHE
VUOTE**

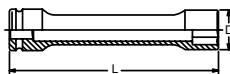



Koken articolo	mm	mm	L mm	
8102M-400-41WX21W	41	21	400	1



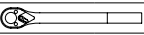

Koken articolo	DESCRIZIONE
8225M-00	Cassetta metallica 15 Pz. 600 x 217 x h 97 mm

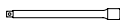
RICAMBI

BUSSOLE	32, 33, 36, 41, 46, 50, 55, 60, 65, 70, 75, 80
	ESAGONO
	8749 
ACCESSORI	8760-200 
	8760-400 

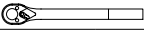

Koken articolo	DESCRIZIONE
8225M-05	Cassetta metallica 15 Pz. 600 x 217 x h 97 mm
RICAMBI	
BUSSOLE	32, 33, 36, 41, 46, 50, 55, 60, 65, 70, 75, 80
	POLIGONALE
	8749 
ACCESSORI	8760-200 
	8760-400 



**CHIAVI A BUSSOLA
MASCHIO
ESAGONALE
INTEGRALE**

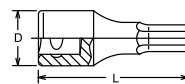

Koken articolo	mm	D mm	L mm	
8012M-80-17	17	44.2	80	1
8012M-80-19	19	44.2	80	1
8012M-80-22	22	47.9	80	1
8012M-80-24	24	47.9	80	1
8012M-80-27	27	47.9	80	1
8012M-80-30	30	47.9	80	1
8012M-80-32	32	47.9	80	1
8012M-80-36	36	54.2	80	1



SFERA

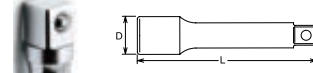

PROLUNGHE CON ATTACCO QUADRO

Koken articolo	D mm	L mm	
8760-200	44	200	1
8760-400	44	400	1

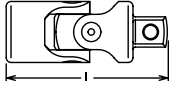

SNODO

Koken articolo	L mm	
8770	143	1

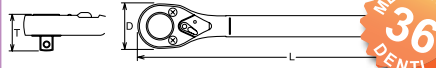

MECCANISMO
36
DENTI

CRICCHETTO PORTABUSSOLA REVERSIBILE CON LEVA DI MANOVRA

Koken articolo	D mm	T mm	L mm	
8749	70	62,2	800	1
8749-1000	70	62,2	1020	1

RICAMBIO CRICCHETTO

8749-HEAD <small>novità</small>	70	62,2	220	1
---------------------------------	----	------	-----	---

RICAMBI MANICO

PIPE-580	-	-	580	1
PIPE-800	-	-	800	1

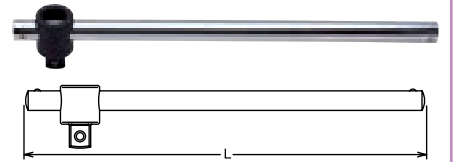

QUADRO MASCHIO CON ASTA SCORREVOLE

Koken articolo	L mm	
8785	550	1
8785-700	700	1



QUADRO MASCHIO AD ANGOLO

Koken articolo	L mm	
8788	600	1



SFERA

RACCORDO DI RIDUZIONE MASCHIO/FEMMINA CON SFERA DI TENUTA NEL QUADRO MASCHIO

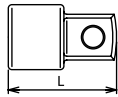

JAPAN

Koken articolo	F	M	L mm	
2233 A	1/4"	3/8"	22	1
3322 A	3/8"	1/4"	24	1
3344 A	3/8"	1/2"	35	1
4433 A-35	1/2"	3/8"	35	1
4433 A-75	1/2"	3/8"	75	1
4433 A-125	1/2"	3/8"	125	1
4433 A-250	1/2"	3/8"	250	1
4433 A-600	1/2"	3/8"	600	1
4466 A	1/2"	3/4"	42	1
6644 A	3/4"	1/2"	47	1
6688 A	3/4"	1"	60	1
8866 A	1"	3/4"	60	1

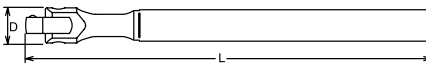

QUADRO MASCHIO SNODATO CON LEVA DI MANOVRA

Koken articolo	D mm	L mm	
8768	55	600	1
8768-1000	55	1000	1

RICAMBIO TESTA

8768-HEAD <small>novità</small>	55	200	1
---------------------------------	----	-----	---

RICAMBI MANICO

PIPE-400	-	400	1
PIPE-800	-	800	1





BUSSOLE CHROM-VANADIUM

Attacco: 1"
impronta: ESAGONO

BGS articolo	mm	L mm	
BGS 3736	36	65	1
BGS 3741	41	70	1
BGS 3746	46	75	1
BGS 3750	50	75	1
BGS 3755	55	80	1
BGS 3760	60	85	1
BGS 3765	65	87	1
BGS 3770	70	90	1
BGS 3775	75	95	1
BGS 3780	80	100	1



PROLUNGHE

attacco: 1"

BGS articolo	L mm	
BGS 372	200	1
BGS 374	400	1



BGS articolo	DESCRIZIONE
BGS 206	ADATTATORE SCORREVOLE PER BARRE ATT. 1"

CARATTERISTICHE

- cromata, satinata
- per impiego con prolunghe
- foro Ø 28,5 mm
- peso: 660 g

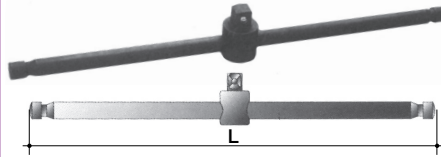

LEVA CON QUADRO SCORREVOLE "POWER IMPACT" BRUNITA

Attacco: 1"

FEARMEC articolo	1"	L mm	
755050	1"	760	1



BGS articolo	DESCRIZIONE
BGS 375	LEVA CON QUADRO SCORREVOLE, ATT. 1"

CARATTERISTICHE

- modello ad alta resistenza
- lunghezza 560 mm
- Ø 28 mm
- peso: 3,3 kg



BGS 300-1 BGS 300-RPAIR



BGS articolo	DESCRIZIONE
BGS 300	CHIAVE A CRICCHETTO REVERSIBILE EXTRA LUNGA

CARATTERISTICHE

- lunghezza da 550 mm
- peso: 4,4 kg

RICAMBI

BGS articolo	DESCRIZIONE
BGS 300-1	LEVA DI MANOVRA
BGS 300-REPAIR	KIT DI RIPARAZIONE



BGS articolo	DESCRIZIONE
BGS 376	IMPUGNATURA SNODATA LUNGH. 1000 MM, ATT. 1"

CARATTERISTICHE

- lunghezza 1000 mm
- cromata lucida
- alta resistenza
- coppia massima 2400 Nm
- peso: 3,8 kg

RICAMBI

BGS articolo	DESCRIZIONE
BGS 377	KIT DI RIPARAZIONE TESTA SNODATA



PRO +



ESAGONO

BGS articolo	DESCRIZIONE
BGS 1210	SET 15 PEZZI, BUSSOLE ATT. 1"

CARATTERISTICHE

- cricchetto reversibile a 24 denti, lungh. 680 mm
- 2 prolunghe: 200 mm + 400 mm
- leva a "T" con quadro scorrevole da 500 mm
- 10 bussole esagonali: 36-41-46-50-55-60-65-70-75-80 mm
- peso: 30,0 kg

RICAMBI

BGS articolo	DESCRIZIONE
BGS 1210-LEER	CASSETTA VUOTA



ESAGONO

BGS articolo	DESCRIZIONE
BGS 15111	SET 15 PEZZI, BUSSOLE, 36 - 80 MM, ATT. 1"

CARATTERISTICHE

- cricchetto
- leva a T con quadro scorrevole
- barra di prolunga da 200 mm
- barra di prolunga da 450 mm
- bussole esagonali : 36 - 41 - 46 - 50 - 55 - 60 - 65 - 70 - 75 - 80 mm
- in cassetta metallica
- con scanalatura e foro per spina
- peso: 26,2 kg

NOTE



BUSSOLE "POWER IMPACT"

attacco: 1"

impronta: ESAGONO

FEFMEC articolo	mm	L mm	
1991-17	17	58	1
1991-19	19	58	1
1991-20	20	58	1
1991-21	21	58	1
1991-22	22	58	1
1991-23	23	58	1
1991-24	24	58	1
1991-25	25	58	1
1991-26	26	58	1
1991-27	27	58	1
1991-28	28	58	1
1991-29	29	60	1
1991-30	30	60	1
1991-31	31	60	1
1991-32	32	63	1
1991-33	33	63	1
1991-34	34	65	1
1991-35	35	65	1
1991-36	36	67	1
1991-37	37	67	1
1991-38	38	67	1
1991-39	39	67	1
1991-40	40	67	1
1991-41	41	67	1
1991-42	42	74	1
1991-43	43	74	1
1991-44	44	74	1
1991-45	45	74	1
1991-46	46	74	1
1991-47	47	74	1
1991-48	48	74	1
1991-50	50	80	1
1991-52	52	80	1
1991-54	54	80	1
1991-55	55	76	1
1991-56	56	76	1
1991-58	58	79	1
1991-60	60	82	1
1991-65	65	85	1
1991-70	70	88	1
1991-75	75	92	1
1991-77	77	97	1
1991-80	80	97	1
1991-85	85	100	1
1991-90	90	104	1
1991-95	95	106	1
1991-100	100	112	1
1991-105	105	112	1
1991-110	110	122	1
1991-115	115	122	1



BUSSOLE "POWER IMPACT"

attacco: 1"

impronta: ESAGONO

BGS articolo	mm	L mm	
BGS 5827	27	58	1
BGS 5830	30	60	1
BGS 5832	32	63	1
BGS 5833	33	63	1
BGS 5834	34	65	1
BGS 5835	35	65	1
BGS 5836	36	67	1
BGS 5838	38	67	1
BGS 5839	39	67	1
BGS 5841	41	67	1
BGS 5846	46	74	1
BGS 5850	50	80	1
BGS 5855	55	76	1
BGS 5856	56	76	1
BGS 5860	60	82	1
BGS 5865	65	85	1
BGS 5870	70	88	1
BGS 5875	75	96	1
BGS 5880	80	96	1
BGS 5885	85	100	1
BGS 5890	90	106	1
BGS 5895	95	106	1
BGS 5905	105	106	1
BGS 5910	110	106	1
BGS 5915	115	106	1
BGS 5920	120	106	1

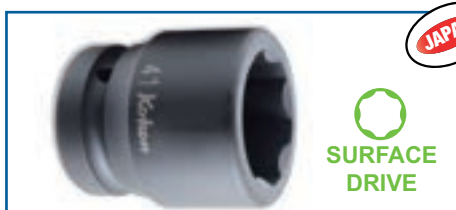

CHIAVI A BUSSOLA A MACCHINA BOCCA SURFACE DRIVE

Koken articolo	mm	D mm	L mm	
18410M-19 <i>novità</i>	19	35,3	57	1
18410M-22 <i>novità</i>	22	39	57	1
18410M-24	24	41,5	57	1
18410M-27	27	45,3	57	1
18410M-30	30	49	62	1
18410M-32	32	51,5	62	1
18410M-33	33	52,8	62	1
18410M-36	36	56,5	62	1
18410M-41	41	62,8	62	1



1" ESAGONO

CASSETTA METALLICA PZ. 8 BUSSOLE 1" 24 - 27 - 30 - 32 - 33 - 36 - 38 - 41 MM

attacco: 1"

impronta: ESAGONO

FEFMEC articolo	Descrizione	
199128	CASSETTA METALLICA 8 PEZZI	1



1" ESAGONO CROMO PRO+

BGS articolo	DESCRIZIONE
BGS 5245	SET 8 PEZZI, BUSSOLE A MACCHINA, ATT. 1"

CARATTERISTICHE

- finitura fosfatata
- con scanalatura e foro per spina
- 27-30-32-36-38-41-46-50 mm
- in cassetta metallica
- peso: 7,5 kg

RICAMBI

BGS articolo	DESCRIZIONE
BGS 5245-LEER	CASSETTA VUOTA

IMPACT 1"



PARETI SOTTILI

JAPAN



CHIAVI A BUSSOLA
A MACCHINA
BOCCA ESAGONALE
PARETI SOTTILI

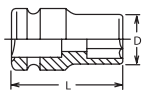

Koken articolo	mm	D mm	L mm	
18401M-17	17	29.8	57	1
18401M-18	18	31	57	1
18401M-19	19	32.3	57	1
18401M-20	20	33.5	57	1
18401M-21	21	34.8	57	1
18401M-22	22	36	57	1
18401M-24	24	38.5	57	1
18401M-26	26	41	70	1
18401M-27	27	42.3	57	1
18401M-29	29	44.8	57	1
18401M-30	30	46	62	1
18401M-32	32	48.5	62	1
18401M-33	33	49.8	62	1
18401M-35	35	52.3	62	1
18401M-36	36	53.5	62	1
18401M-38	38	56	66	1
18401M-41	41	59.8	66	1
18401M-42	42	61	66	1
18401M-46	46	66	70	1
18401M-47	47	67.3	70	1
18401M-50	50	71	70	1



ESAGONO

CHIAVI A BUSSOLA
A MACCHINA
BOCCA ESAGONALE

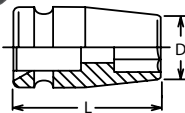

Koken articolo	mm	D mm	L mm	
18400M-17	17	32.8	57	1
18400M-18	18	34	57	1
18400M-19	19	35.3	57	1
18400M-20	20	36.5	57	1
18400M-21	21	37.8	57	1
18400M-22	22	39	57	1
18400M-23	23	40.3	57	1
18400M-24	24	41.5	57	1
18400M-25	25	42.8	57	1
18400M-26	26	44	57	1
18400M-27	27	45.3	57	1
18400M-28	28	46.5	57	1
18400M-29	29	47.8	57	1
18400M-30	30	49	62	1
18400M-31	31	50.3	62	1
18400M-32	32	51.5	62	1
18400M-33	33	52.8	62	1
18400M-34	34	54	62	1
18400M-35	35	55.3	62	1
18400M-36	36	56.5	62	1
18400M-37	37	57.8	62	1
18400M-38	38	59	66	1
18400M-39	39	60.3	66	1
18400M-40	40	61.5	66	1
18400M-41	41	62.8	66	1
18400M-42	42	64	66	1
18400M-43	43	65.3	68	1
18400M-44	44	66.5	68	1
18400M-45	45	67.8	68	1
18400M-46	46	69	70	1
18400M-47	47	70.3	70	1
18400M-48	48	71.5	70	1
18400M-50	50	74	70	1
18400M-52	52	76.5	75	1
18400M-54	54	79	75	1
18400M-55	55	80.3	75	1
18400M-56	56	81.5	75	1
18400M-58	58	84	75	1
18400M-60	60	86.5	75	1
18400M-62	62	89	75	1
18400M-63	63	90.3	75	1
18400M-65	65	92.8	75	1
18400M-67	67	95.3	75	1
18400M-68	68	96.5	75	1
18400M-70	70	99	75	1
18400M-75	75	105.3	80	1
18400M-77	77	107.8	80	1
18400M-80	80	111.5	85	1
18400M-85	85	117.8	90	1
18400M-90	90	124	95	1
18400M-95	95	130.3	100	1
18400M-100	100	136.5	105	1

JAPAN POLLICI

JAPAN



CHIAVI A BUSSOLA
A MACCHINA
BOCCA ESAGONALE

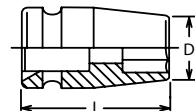

Koken articolo	pollici	D mm	L mm	
18400A-11/16	11/16"	32.8	57	1
18400A-3/4	3/4"	35.3	57	1
18400A-13/16	13/16"	37.8	57	1
18400A-7/8	7/8"	39	57	1
18400A-15/16	15/16"	41.5	57	1
18400A-1	1"	42.8	57	1
18400A-1-1/16	1-1/16"	45.3	57	1
18400A-1-3/32	1-3/32"	46.5	57	1
18400A-1-1/8	1-1/8"	47.8	57	1
18400A-1-3/16	1-3/16"	49	62	1
18400A-1-1/4	1-1/4"	51.5	62	1
18400A-1-9/32	1-9/32"	52.8	62	1
18400A-1-5/16	1-5/16"	54	62	1
18400A-1-3/8	1-3/8"	55.3	62	1
18400A-1-7/16	1-7/16"	57.8	62	1
18400A-1-15/32	1-15/32"	57.8	62	1
18400A-1-1/2	1-1/2"	59	66	1
18400A-1-9/16	1-9/16"	61.5	66	1
18400A-1-5/8	1-5/8"	62.8	66	1
18400A-1-11/16	1-11/16"	65.3	68	1
18400A-1-3/4	1-3/4"	67.8	68	1
18400A-1-13/16	1-13/16"	69	70	1
18400A-1-7/8	1-7/8"	71.5	70	1
18400A-1-15/16	1-15/16"	72.8	70	1
18400A-2	2"	75.3	70	1
18400A-2-1/16	2-1/16"	76.5	75	1
18400A-2-1/8	2-1/8"	79	75	1
18400A-2-3/16	2-3/16"	80.3	75	1
18400A-2-1/4	2-1/4"	82.8	75	1
18400A-2-5/16	2-5/16"	84	75	1
18400A-2-3/8	2-3/8"	86.5	75	1
18400A-2-7/16	2-7/16"	89	75	1
18400A-2-1/2	2-1/2"	91.5	75	1
18400A-2-9/16	2-9/16"	92.8	75	1
18400A-2-5/8	2-5/8"	95.3	75	1
18400A-2-11/16	2-11/16"	96.5	75	1
18400A-2-3/4	2-3/4"	99	75	1
18400A-2-13/16	2-13/16"	101.5	75	1
18400A-2-7/8	2-7/8"	102.8	80	1
18400A-2-15/16	2-15/16"	105.3	80	1
18400A-3	3"	106.5	80	1
18400A-3-1/16	3-1/16"	109	85	1
18400A-3-1/8	3-1/8"	111.5	85	1
18400A-3-1/4	3-1/4"	115.3	90	1
18400A-3-3/8	3-3/8"	119	90	1
18400A-3-1/2	3-1/2"	124	95	1
18400A-3-3/4	3-3/4"	130.3	100	1
18400A-3-7/8	3-7/8"	135.3	105	1
18400A-4	4"	137.8	105	1

POLLICI



1"

ESAGONO

MISURE IN POLLICI - A RICHIESTA ALTRE MISURE

attacco: 1"

impronta: ESAGONO

FEWMEC articolo	pollici	L mm	
1991-7/8	7/8"	55	1
1991-15/16	15/16"	55	1
1991-1	1"	55	1
1991-1-1/8	1-1/8"	57	1
1991-1-1/4	1-1/4"	57	1
1991-1-5/16	1-5/16"	60	1
1991-1-7/16	1-7/16"	60	1
1991-1-9/16	1-9/16"	64	1
1991-1-5/8	1-5/8"	69	1
1991-1-11/16	1-11/16"	69	1
1991-1-3/4	1-3/4"	69	1
1991-1-7/8	1-7/8"	72	1
1991-1-15/16	1-15/16"	72	1
1991-2	2"	72	1
1991-2-1/16	2-1/16"	80	1
1991-2-3/16	2-3/16"	80	1
1991-2-1/4	2-1/4"	80	1
1991-2-5/16	2-5/16"	85	1
1991-2-3/8	2-3/8"	85	1
1991-2-7/16	2-7/16"	85	1
1991-2-1/2	2-1/2"	85	1
1991-2-5/8	2-5/8"	91	1
1991-2-11/16	2-11/16"	91	1
1991-2-13/16	2-13/16"	92	1
1991-2-7/8	2-7/8"	92	1
1991-3	3"	97	1
1991-3-1/16	3-1/16"	100	1
1991-3-1/8	3-1/8"	100	1
1991-3-3/16	3-3/16"	100	1
1991-3-1/4	3-1/4"	100	1
1991-3-5/16	3-5/16"	100	1
1991-3-3/8	3-3/8"	104	1
1991-3-7/16	3-7/16"	104	1
1991-3-1/2	3-1/2"	104	1
1991-3-9/16	3-9/16"	104	1
1991-3-5/8	3-5/8"	104	1
1991-3-11/16	3-11/16"	104	1
1991-3-13/16	3-13/16"	112	1
1991-3-7/8	3-7/8"	112	1
1991-4	4"	112	1

1"

POLIGONALE

POLIGONALI

attacco: 1"

impronta: POLIGONALE

FEWMEC articolo	mm	L mm	
1991-19 DSKT	19	55	1
1991-20 DSKT	20	55	1
1991-21 DSKT	21	55	1
1991-22 DSKT	22	55	1
1991-24 DSKT	24	55	1
1991-25 DSKT	25	55	1
1991-26 DSKT	26	55	1
1991-27 DSKT	27	55	1
1991-28 DSKT	28	55	1
1991-30 DSKT	30	57	1
1991-32 DSKT	32	57	1
1991-33 DSKT	33	57	1
1991-35 DSKT	35	60	1
1991-36 DSKT	36	60	1
1991-38 DSKT	38	64	1
1991-40 DSKT	40	64	1
1991-41 DSKT	41	64	1
1991-46 DSKT	46	64	1
1991-47 DSKT	47	64	1
1991-50 DSKT	50	67	1
1991-54 DSKT	54	71	1
1991-55 DSKT	55	71	1
1991-58 DSKT	58	75	1
1991-60 DSKT	60	80	1
1991-65 DSKT	65	85	1
1991-70 DSKT	70	88	1
1991-75 DSKT	75	100	1
1991-80 DSKT	80	100	1
1991-85 DSKT	85	100	1
1991-90 DSKT	90	104	1
1991-95 DSKT	95	106	1
1991-100 DSKT	100	112	1
1991-105 DSKT	105	112	1
1991-110 DSKT	110	122	1
1991-115 DSKT	115	122	1

JAPAN



POLIGONALE

CHIAVI A BUSSOLA
A MACCHINA
BOCCA POLIGONALE

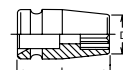

Kokon articolo	mm	D mm	L mm	
18405M-24	24	41.5	57	1
18405M-27	27	45.3	57	1
18405M-30	30	49	62	1
18405M-32	32	51.5	62	1
18405M-33	33	52.8	62	1
18405M-35	35	55.3	62	1
18405M-36	36	56.5	62	1
18405M-38	38	59	66	1
18405M-40	40	62.8	66	1
18405M-41	41	61.5	66	1
18405M-46	46	69	70	1
18405M-50	50	74	70	1
18405M-55	55	80.3	75	1
18405M-56	56	81.5	75	1
18405M-60	60	86.5	75	1
18405M-65	65	92.8	75	1
18405M-70	70	99	75	1
18405M-75	75	105.3	80	1
18405M-80	80	111.5	85	1

IMPACT 1"

JAPAN



POLIGONALE

CHIAVI A BUSSOLA
A MACCHINA
BOCCA POLIGONALE
RIBASSATE

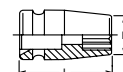

Kokon articolo	mm	D mm	L mm	
18405M-50(D68)	50	68	75	1
18405M-55(D76)	55	76	75	1
18405M-65(D87)	65	87	75	1



POLLICI



1"

POLIGONALE

MISURE IN POLLICI

attacco: 1"

impronta: POLIGONALE

FEEMEC articolo	pollici	L mm	
1991-3/4 DSKT	3/4"	55	1
1991-13/16 DSKT	13/16"	55	1
1991-7/8 DSKT	7/8"	55	1
1991-15/16 DSKT	15/16"	55	1
1991-1 DSKT	1"	55	1
1991-1-1/8 DSKT	1-1/8"	57	1
1991-1-1/4 DSKT	1-1/4"	57	1
1991-1-5/16 DSKT	1-5/16"	60	1
1991-1-7/16 DSKT	1-7/16"	60	1
1991-1-1/2 DSKT	1-1/2"	60	1
1991-1-9/16 DSKT	1-9/16"	64	1
1991-1-11/16 DSKT	1-11/16"	69	1
1991-1-3/4 DSKT	1-3/4"	69	1
1991-1-7/8 DSKT	1-7/8"	69	1
1991-1-15/16 DSKT	1-15/16"	72	1
1991-2 DSKT	2"	72	1
1991-2-1/16 DSKT	2-1/16"	72	1
1991-2-1/8 DSKT	2-1/8"	76	1
1991-2-3/16 DSKT	2-3/16"	76	1
1991-2-1/4 DSKT	2-1/4"	80	1
1991-2-5/16 DSKT	2-5/16"	80	1
1991-2-3/8 DSKT	2-3/8"	85	1
1991-2-7/16 DSKT	2-7/16"	85	1
1991-2-1/2 DSKT	2-1/2"	85	1
1991-2-5/8 DSKT	2-5/8"	88	1
1991-2-11/16 DSKT	2-11/16"	88	1
1991-2-13/16 DSKT	2-13/16"	92	1
1991-2-7/8 DSKT	2-7/8"	92	1
1991-3 DSKT	3"	97	1
1991-3-1/16 DSKT	3-1/16"	97	1
1991-3-1/8 DSKT	3-1/8"	97	1
1991-3-3/16 DSKT	3-3/16"	100	1
1991-3-1/4 DSKT	3-1/4"	100	1
1991-3-5/16 DSKT	3-5/16"	100	1
1991-3-3/8 DSKT	3-3/8"	100	1
1991-3-7/16 DSKT	3-7/16"	105	1
1991-3-1/2 DSKT	3-1/2"	105	1
1991-3-9/16 DSKT	3-9/16"	105	1
1991-3-5/8 DSKT	3-5/8"	105	1
1991-3-11/16 DSKT	3-11/16"	105	1
1991-3-13/16 DSKT	3-13/16"	112	1
1991-3-7/8 DSKT	3-7/8"	112	1
1991-4 DSKT	4"	112	1

POLLICI



POLIGONALE

novità

 CHIAVI A BUSSOLA
 A MACCHINA
 A POLIGONALE
 MISURE IN POLLICI

JAPAN

Koken

FEEMEC articolo	pollici	D mm	L mm	
18405A-3/4	3/4"	35.3	57	1
18405A-7/8	7/8"	39	57	1
18405A-1	1"	42.8	57	1
18405A1-1/8	1-1/8"	47.8	57	1
18405A-1-3/16	1-3/16"	49	62	1
18405A-1-1/4	1-1/4"	51.5	62	1
18405A-1-3/8	1-3/8"	55.3	62	1
18405A-1-7/16	1-7/16"	57.8	62	1
18405A-1-1/2	1-1/2"	59	66	1
18405A-1-3/4	1-3/4"	67.8	68	1
18405A-1-15/16	1-15/16"	72.8	70	1

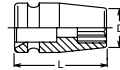

1"



TORX®

TORX®

attacco: 1"

impronta: TORX®

FEEMEC articolo		L mm	
1991-18 GTX	E 18	65	1
1991-20 GTX	E 20	65	1
1991-22 GTX	E 22	65	1
1991-24 GTX	E 24	65	1
1991-26 GTX	E 26	65	1
1991-28 GTX	E 28	65	1
1991-30 GTX	E 30	65	1
1991-32 GTX	E 32	65	1

TORX®

S

S

	S mm		S mm
E 4	3.70	E 16	14.60
E 5	4.60	E 18	16.50
E 6	5.60	E 20	18.30
E 7	6.10	E 22	20.10
E 8	7.40	E 24	22.00
E 10	9.30	E 26	23.70
E 11	9.90	E 28	25.50
E 12	11.00	E 30	27.30
E 14	12.80	E 32	29.00



1"



QUADRO

QUADRO FEMMINA

attacco: 1"

impronta: QUADRA

FEEMEC articolo	mm	L mm	
1991-20 VKT	20	60	1
1991-21 VKT	21	60	1
1991-22 VKT	22	60	1
1991-24 VKT	24	60	1
1991-27 VKT	27	60	1
1991-30 VKT	30	60	1
1991-32 VKT	32	60	1
1991-36 VKT	36	60	1
1991-38 VKT	38	60	1
1991-41 VKT	41	60	1
1991-43 VKT	43	70	1
1991-46 VKT	46	70	1
1991-51 VKT	51	70	1
1991-1-3/4" VKT	1-3/4"	70	1
1991-1-7/8" VKT	1-7/8"	70	1

POLLICI

JAPAN

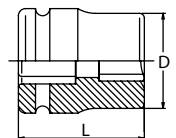

QUADRO

BUSSOLE
QUADRO
FEMMINA

Koken articolo	mm	D mm	L mm	
PS 8-17	17	40	60	1
PS 8-19	19	43	60	1
PS 8-20	20	45	62	1
PS 8-21	21	45	64	1



1" **RETTANGOLO**

RETTANGOLARI - SETTORE FERROVIARIO

attacco: 1"
impronta: RETTANGOLO

FEIMEC articolo	mm	L mm	
1991-21-28 RVKT-70	21 x 28	70	1
1991-19-21 RVKT	19 x 21	110	1
1991-21-28 RVKT	21 x 28	110	1



JAPAN

ESAGONO

CHIAVI A BUSSOLA A MACCHINA BOCCA ESAGONALE TIPO LUNGO



Koken articolo	mm	D mm	L mm	
18300M-17	17	32.8	108	1
18300M-19	19	35.3	108	1
18300M-20	20	36.5	108	1
18300M-21	21	37.8	108	1
18300M-22	22	39	108	1
18300M-23	23	40.3	108	1
18300M-24	24	41.5	108	1
18300M-25	25	42.8	108	1
18300M-26	26	44	108	1
18300M-27	27	45.3	108	1
18300M-28	28	46.5	108	1
18300M-29	29	47.8	108	1
18300M-30	30	49	108	1
18300M-31	31	50.3	108	1
18300M-32	32	51.5	108	1
18300M-33	33	52.8	108	1
18300M-34	34	54	108	1
18300M-35	35	55.3	108	1
18300M-36	36	56.5	108	1
18300M-37	37	57.8	108	1
18300M-38	38	59	108	1
18300M-40	40	61.5	108	1
18300M-41	41	62.8	108	1
18300M-42	42	64	108	1
18300M-44	44	66.5	108	1
18300M-45	45	67.8	108	1
18300M-46	46	69	108	1
18300M-48	48	71.5	108	1
18300M-50	50	74	108	1
18300M-52	52	76.5	108	1
18300M-55	55	80.3	108	1
18300M-60	60	86.5	108	1
18300M-65	65	92.8	108	1
18300M-70	70	99	108	1
18300M-75	75	105.3	108	1
18300M-80	80	117.8	108	1
18300M-85	85	117.8	108	1
18300M-90	90	124	108	1
18300M-95	95	130.3	108	1





JAPAN

ESAGONO

CHIAVI A BUSSOLA A MACCHINA BOCCA ESAGONALE SEMI LUNGA



Koken articolo	mm	D mm	L mm	
18301X-17	17	29.8	80	1
18301X-19	19	32.3	80	1
18301X-21	21	34.8	80	1
18301X-22	22	36	80	1
18301X-24	24	38.5	80	1
18301X-27	27	42.3	80	1
18301X-30	30	46	80	1
18301X-32	32	48.5	85	1
18301X-33	33	49.8	85	1
18301X-35	35	52.3	85	1
18301X-36	36	53.5	85	1
18301X-38	38	56	85	1
18301X-41	41	59.8	85	1
18301X-46	46	66	85	1
18301X-50	50	71	85	1



JAPAN

SURFACE DRIVE

CHIAVI A BUSSOLA A MACCHINA BOCCA SURFACE DRIVE TIPO LUNGO

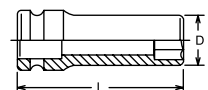

Koken articolo	mm	D mm	L mm	
18310M-24	24	41,5	108	1
18310M-27	27	45,3	108	1
18310M-30	30	49	108	1
18310M-32	32	51,5	108	1
18310M-33	33	52,8	108	1
18310M-36	36	56,5	108	1
18310M-41	41	62,8	108	1



1"



ESAGONO

LUNGHE

 attacco: 1"
 impronta: ESAGONO

FEARMEC articolo	mm	L mm	
1991-19 L	19	100	1
1991-21 L	21	100	1
1991-22 L	22	100	1
1991-23 L	23	100	1
1991-24 L	24	100	1
1991-27 L	27	100	1
1991-28 L	28	100	1
1991-30 L	30	100	1
1991-32 L	32	100	1
1991-33 L	33	100	1
1991-34 L	34	100	1
1991-35 L	35	100	1
1991-36 L	36	100	1
1991-38 L	38	100	1
1991-39 L	39	100	1
1991-40 L	40	100	1
1991-41 L	41	100	1
1991-42 L	42	100	1
1991-43 L	43	100	1
1991-44 L	44	100	1
1991-45 L	44	100	1
1991-46 L	46	100	1
1991-48 L	48	100	1
1991-49 L	49	100	1
1991-50 L	50	100	1
1991-51 L	51	105	1
1991-52 L	52	105	1
1991-54 L	54	105	1
1991-55 L	55	105	1
1991-57 L	57	105	1
1991-60 L	60	105	1
1991-65 L	65	118	1
1991-70 L	70	124	1
1991-75 L	75	124	1
1991-80 L	80	132	1
1991-85 L	85	132	1
1991-90 L	90	140	1
1991-95 L	95	140	1
1991-100 L	100	143	1
1991-105 L	105	143	1
1991-110 L	110	149	1
1991-115 L	115	149	1



1"



CROMO



ESAGONO

LUNGHE

 attacco: 1"
 impronta: ESAGONO

BGS articolo	mm	L mm	
BGS 5500-17	17	90	1
BGS 5500-19	19	90	1
BGS 5500-21	21	90	1
BGS 5500-22	22	90	1
BGS 5500-24	24	90	1
BGS 5500-27	27	90	1
BGS 5500-30	30	90	1
BGS 5500-32	32	90	1
BGS 5500-33	33	90	1
BGS 5500-34	34	90	1
BGS 5500-36	36	90	1
BGS 5500-38	38	90	1
BGS 5500-41	41	95	1
BGS 5500-46	46	95	1
BGS 5500-50	50	100	1
BGS 5500-55	55	105	1
BGS 5500-60	60	110	1
BGS 5500-65	65	115	1
BGS 5500-70	70	115	1
BGS 5500-75	75	115	1
BGS 5500-80	80	135	1
BGS 5500-85	85	140	1
BGS 5500-90	90	140	1
BGS 5500-95	95	140	1
BGS 5500-100	100	155	1
BGS 5500-105	105	155	1
BGS 5500-110	110	155	1
BGS 5500-115	115	155	1



1"



ESAGONO



CROMO

PRO+

BGS
articolo

DESCRIZIONE

BGS 5500

**SET 8 PEZZI,
 BUSSOLE A MACCHINA
 LUNGHE, ATT. 1"**

CARATTERISTICHE

- finitura fosfatata
- comprende le seguenti bussole esagonali:
 - 27 mm, lung. 90 mm - 30 mm, lung. 90 mm
 - 32 mm, lung. 90 mm - 36 mm, lung. 90 mm
 - 38 mm, lung. 95 mm - 41 mm, lung. 95 mm
 - 46 mm, lung. 95 mm - 50 mm, lung. 100 mm
- con scanalatura e foro per spina
- in cassetta metallica
- peso: 9,7 kg



POLLICI



ESAGONO

**CHIAVI A BUSSOLA
A MACCHINA
BOCCA ESAGONALE
TIPO LUNGO**

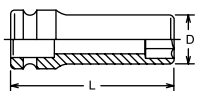

Koken articolo	 pollici	D mm	L mm	
18300A-11/16	11/16"	32.8	108	1
18300A-3/4	3/4"	35.3	108	1
18300A-7/8	7/8"	39	108	1
18300A-15/16	15/16"	41.5	108	1
18300A-1	1"	42.8	108	1
18300A-1-1/16	1-1/16"	45.3	108	1
18300A-1-1/8	1-1/8"	47.8	108	1
18300A-1-3/16	1-3/16"	49	108	1
18300A-1-1/4	1-1/4"	51.5	108	1
18300A-1-5/16	1-5/16"	54	108	1
18300A-1-3/8	1-3/8"	55.3	108	1
18300A-1-7/16	1-7/16"	57.8	108	1
18300A-1-1/2	1-1/2"	59	108	1
18300A-1-9/16	1-9/16"	61.5	108	1
18300A-1-5/8	1-5/8"	62.8	108	1
18300A-1-11/16	1-11/16"	65.3	108	1
18300A-1-3/4	1-3/4"	67.8	108	1
18300A-1-13/16	1-13/16"	69	108	1
18300A-1-7/8	1-7/8"	71.5	108	1
18300A-1-15/16	1-15/16"	72.8	108	1
18300A-2	2"	75.3	108	1
18300A-2-1/16	2-1/16"	76.5	108	1
18300A-2-1/8	2-1/8"	79	108	1
18300A-2-3/16	2-3/16"	80.3	108	1
18300A-2-1/4	2-1/4"	82.8	108	1
18300A-2-5/16	2-5/16"	84	108	1
18300A-2-3/8	2-3/8"	86.5	108	1
18300A-2-7/16	2-7/16"	89	108	1
18300A-2-1/2	2-1/2"	91.5	108	1
18300A-2-9/16	2-9/16"	92.8	108	1
18300A-2-5/8	2-5/8"	95.3	108	1
18300A-2-3/4	2-3/4"	99	108	1
18300A-2-7/8	2-7/8"	102.8	108	1
18300A-2-15/16	2-15/16"	105.3	108	1
18300A-3	3"	106.5	108	1
18300A-3-1/16	3-1/16"	109	108	1
18300A-3-1/8	3-1/8"	111.5	108	1
18300A-3-3/16	3-3/16"	112.8	108	1

JAPAN

PARETI SOTTILI



ESAGONO

**CHIAVI A BUSSOLA
A MACCHINA BOCCA
ESAGONALE PARETI
SOTTILI TIPO LUNGO**

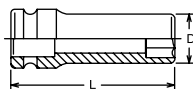

Koken articolo	 mm	D mm	L mm	
18301M-17	17	29.8	108	1
18301M-18	18	31	108	1
18301M-19	19	32.3	108	1
18301M-20	20	33.5	108	1
18301M-21	21	34.8	108	1
18301M-22	22	36	108	1
18301M-23	23	37.3	108	1
18301M-24	24	38.5	108	1
18301M-26	26	41	108	1
18301M-27	27	42.3	108	1
18301M-29	29	44.8	108	1
18301M-30	30	46	108	1
18301M-32	32	48.5	108	1
18301M-33	33	49.8	108	1
18301M-34	34	51	108	1
18301M-35	35	52.3	108	1
18301M-36	36	53.5	108	1
18301M-38	38	56	108	1
18301M-39	39	57.3	108	1
18301M-41	41	59.8	108	1
18301M-42	42	61	108	1
18301M-43	43	62.3	108	1
18301M-46	46	66	108	1
18301M-50	50	71	108	1
18301M-55	55	77.3	108	1
18301M-60	60	83.5	108	1
18301M-65	65	89.8	108	1
18301M-70	70	96	108	1

JAPAN

TRUCK



ESAGONO QUADRO

**CHIAVI A BUSSOLA
A MACCHINA PER
AUTOTRENO**

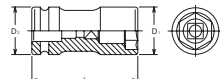

Koken articolo	 mm	 mm	L mm	
18316M-35X17	35	17	108	1
18316M-38X20	38	20	108	1
18316M-41X19	41	19	108	1
18316M-41X21	41	21	108	1
18316A-1-1/2X13/16	1-1/2"	13/16	108	1

POLLICI

TRUCK



1"

OTTAGONALE

**CHIAVI A BUSSOLA
BOCCA
OTTAGONALE
OTTO LATI
TIPO LUNGO**



FERMEC articolo	 mm	L mm	
1991-70 OKT	70	140	1
1991-80 OKT	80	140	1
1991-83 OKT	83	140	1
1991-85 OKT	85	140	1
1991-86 OKT	86	140	1
1991-90 OKT	90	140	1
1991-95 OKT	95	140	1
1991-96 OKT	96	140	1
1991-100 OKT	100	140	1
1991-102 OKT	102	140	1
1991-103 OKT	103	140	1
1991-105 OKT	105	140	1
1991-108 OKT	108	140	1
1991-110 OKT	110	140	1
1991-115 OKT	115	140	1
1991-118 OKT	118	140	1
1991-120 OKT	120	140	1
1991-125 OKT	125	140	1
1991-130 OKT	130	140	1
1991-135 OKT	135	140	1
1991-140 OKT	140	140	1

IMPACT 1"

 BARRE DI
 TORSIONE

JAPAN

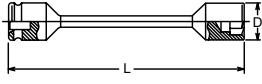
 BARRE DI
 TORSIONE
 BOCCA
 ESAGONALE

Kokon articolo	mm	Nm	D mm	L mm	
18101M-24 X 350 NM	24	350	43.5	300	1
18101M-27 X 350 NM	27	350	47	300	1
18101M-27 X 450 NM	27	450	47	300	1
18101M-29 X 400 NM	29	400	47.8	300	1
18101M-30 X 500 NM	30	500	51	300	1
18101M-32 X 450 NM	32	450	51.5	300	1
18101M-32 X 550 NM	32	550	51.5	300	1
18101M-32 X 600 NM	32	600	51.5	300	1
18101M-32 X 650 NM	32	650	51.5	300	1
18101M-32 X 700 NM	32	700	51.5	300	1
18101M-33 X 550 NM	33	550	55	300	1
18101M-33 X 600 NM	33	600	55	300	1
18101M-33 X 650 NM (OZAT)	33	650	58.5	300	1
18101M-36 X 600 NM	36	600	58.5	300	1

Non utilizzare la barra di torsione per svitare i dadi, ma solo per avvitare.

Per sicurezza, controllare sempre il serraggio con chiave dinamometrica.



PRO+



BARRE DI TORSIONE, BOCCA ESAGONALE

BGS articolo	mm	Nm	L mm
BGS 6940	24	350	305
BGS 6941	27	350	305
BGS 6942	30	350	305
BGS 6943	32	450	305
BGS 6944	32	500	305
BGS 6945	33	550	305
BGS 6946	33	650	305
BGS 6947	36	600	305

CARATTERISTICHE

- assorbe la coppia eccessiva e la limita alla coppia richiesta
- per l'uso con l'avvitatori ad impulsi
- può essere fissato sull'avvitatore a impulsi con un perno e un O-ring
- DIN 3121
- attacco: quadro femmina 1"
- impronta: esagonale
- lunghezza: 305 mm



JAPAN

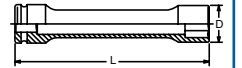

VUOTE

 CHIAVI A BUSSOLA
 EXTRA LUNGHE
 VUOTE

Kokon articolo	mm	D mm	L mm	
18102M-270-23	23	37.3	270	1
18102M-270-24	24	38.5	270	1
18102M-270-26	26	41	270	1
18102M-270-27	27	42.3	270	1
18102M-270-29	29	44.8	270	1
18102M-270-30	30	46	270	1
18102M-270-32	32	48.5	270	1
18102M-270-33	33	49.8	270	1
18102M-270-34	34	51	270	1
18102M-270-36	36	53.5	270	1
18102M-270-38	38	56	270	1
18102M-270-41	41	60	270	1
1991-41L-270	41	FERMEC	270	1
1991-46L-270	46	FERMEC	270	1
1991-50L-270	50	FERMEC	270	1
1991-55L-270	55	FERMEC	270	1
18102M-400-24	24	38.5	400	1
18102M-400-26	26	41	400	1
18102M-400-27	27	42.3	400	1
18102M-400-29	29	44.8	400	1
18102M-400-30	30	46	400	1
18102M-400-32	32	48.5	400	1
18102M-400-33	33	49.8	400	1
18102M-400-34	34	51	400	1
18102M-400-36	36	53.5	400	1
18102M-400-38	38	56	400	1

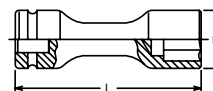

JAPAN

 CHIAVI A
 BUSSOLA EXTRA
 LUNGHE

Kokon articolo	mm	D mm	L mm	
18104M-24	24	41.5	170	1
18104M-27	27	45.3	170	1
18104M-28	28	46.5	170	1
18104M-30	30	49	170	1
18104M-32	32	51.5	170	1
18104M-33	33	52.8	170	1
18104M-34	34	54	170	1
18104M-36	36	56.5	170	1



JAPAN

ESAGONO

CHIAVI A BUSSOLA MASCHIO ESAGONALE INTEGRALE

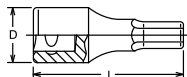

Kokon articolo	mm	D mm	L mm	
8012M-80-17	17	44.2	80	1
8012M-80-19	19	44.2	80	1
8012M-80-22	22	47.9	80	1
8012M-80-24	24	47.9	80	1
8012M-80-27	27	47.9	80	1
8012M-80-30	30	47.9	80	1
8012M-80-32	32	47.9	80	1
8012M-80-36	36	54.2	80	1

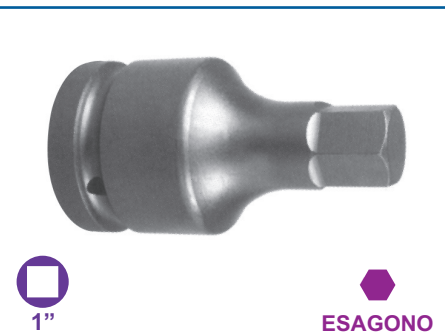

1"

ESAGONO

BUSSOLE ESAGONALI IMPACT MASCHIO BRUNITE CON FORO NEL QUADRO PER SPINA E ANELLO

attacco: 1"			
impronta: ESAGONO BRUGOLA			
FEFMEC articolo	mm	L mm	
181 - 1" - 14	14	70	1
181 - 1" - 17	17	70	1
181 - 1" - 19	19	70	1
181 - 1" - 22	22	75	1
181 - 1" - 24	24	75	1
181 - 1" - 27	27	80	1
181 - 1" - 30	30	80	1
181 - 1" - 32	32	80	1
182 - 1" - 17	17	100	1
182 - 1" - 19	19	100	1
182 - 1" - 22	22	100	1
182 - 1" - 24	24	100	1
182 - 1" - 27	27	100	1
182 - 1" - 30	30	100	1
182 - 1" - 32	32	100	1
182 - 1" - 36	36	100	1
182 - 1" - 38	38	100	1
182 - 1" - 41	41	100	1
182 - 1" - 46	46	100	1
4182 - 1" - 14	14	150	1
4182 - 1" - 17	17	150	1
4182 - 1" - 19	19	150	1
4182 - 1" - 22	22	150	1
4182 - 1" - 24	24	150	1
4182 - 1" - 27	27	150	1
4182 - 1" - 30	30	150	1
4182 - 1" - 32	32	150	1



ESAGONO

FEFMEC articolo	DESCRIZIONE
541051	SET 5 PEZZI, BUSSOLE IMPACT, ESAGONALE MASCHIO, ATT. 1"
CARATTERISTICHE	
<ul style="list-style-type: none"> • lunghezza 100 mm • atta quadro femmina 1" • misure: 17-19-22-24-27 mm • in cassetta 	

POLLICI

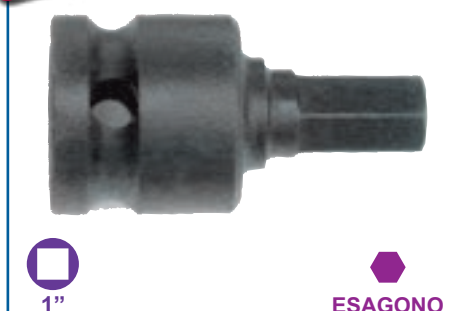

1"

ESAGONO

BUSSOLE ESAGONALI IMPACT MASCHIO BRUNITE CON FORO NEL QUADRO PER SPINA E ANELLO - MISURE IN POLLICI

attacco: 1"			
impronta: ESAGONO BRUGOLA			
FEFMEC articolo	pollici	L mm	
182 W-1"-1/2	1/2"	71	1
182 W-1"-9/16	9/16"	71	1
182 W-1"-5/8	5/8"	71	1
182 W-1"-3/4	3/4"	71	1
182 W-1"-13/16	13/16"	75	1
182 W-1"-7/8	7/8"	75	1
182 W-1"-1	1"	75	1
182 W-1"-1-1/16	1-1/16"	82	1
182 W-1"-1-1/8	1-1/8"	82	1
182 W-1"-1-3/16	1-3/16"	82	1
182 W-1"-1-1/4	1-1/4"	82	1
182 W-1"-1-5/16	1-5/16"	100	1
182 W-1"-1-3/8	1-3/8"	100	1
182 W-1"-1-1/2	1-1/2"	100	1
182 W-1"-1-5/8	1-5/8"	100	1
182 W-1"-1-3/4	1-3/4"	100	1
182 W-1"-1-13/16	1-13/16"	100	1



BUSSOLA PORTAINSERTI 22 mm

Koken
articolo

D mm	L mm	
54	70	1

1" 22 mm



INSERTO CON MASCHIO ESAGONALE PER USO CON BUSSOLA 16107 E 18107

ESAGONO

FEARMEC
articolo

mm	L mm	
7 RB 014	107/140	1
7 RB 017	107/140	1
7 RB 019	107/140	1
7 RB 022	107/140	1
7 RB 024	107/140	1

22 mm

INSERTO CON MASCHIO TORX® PER USO CON BUSSOLA 16107 E 18107

TORX®

FEARMEC
articolo

mm	L mm	
7 LB 060	107/140	1
7 LB 070	107/140	1
7 LB 080	107/140	1
7 LB 090	107/140	1
7 LB 100	107/140	1

22 mm

TORX®		S mm	S mm
T 6	T 40	1.70	6.70
T 7	T 45	2.00	7.90
T 8	T 50	2.30	8.90
T 9	T 55	2.50	11.30
T 10	T 60	2.70	13.30
T 15	T 70	3.30	15.60
T 20	T 80	3.90	17.60
T 25	T 90	4.50	20.00
T 27	T 100	5.00	22.20
T 30		5.60	



SET 16 PEZZI, INSERTI XXL, ATT. 3/4" - 1"

PRO+ **CROMO**

BGS
articolo

BGS 5246

3/4" 1" ESAGONO TORX® TORX®



CARATTERISTICHE

- 13 inserti, attacco esagonale 22 mm:
 - Torx: Tx60, Tx70, Tx 80, Tx 90, Tx 100
 - Esagono: 17, 19, 22, 24 mm
 - Torx femmina: E18, E20, E22, E24
- 2 bussole porta inserti da 22 mm, attacco quadro femmina da 3/4" e 1"
- chiavi esagonali a L per fissaggio inserti sulle bussole
- per uso con avvitatori pneumatici
- inserti attacco esagonale 22 mm
- lunghezza inserti 100 mm
- peso: 6,2 kg

RICAMBI		DESCRIZIONE
BGS articolo		
BGS 5246-T60		INSERTO TX 60
BGS 5246-T70		INSERTO TX 70
BGS 5246-T80		INSERTO TX 80
BGS 5246-T90		INSERTO TX 90
BGS 5246-T100		INSERTO TX 100
BGS 5246-E18		INSERTO E-18
BGS 5246-E20		INSERTO E-20
BGS 5246-E22		INSERTO E-22
BGS 5246-E24		INSERTO E-24
BGS 5246-H17		INSERTO ESAG. 17 MM
BGS 5246-H19		INSERTO ESAG. 19 MM
BGS 5246-H22		INSERTO ESAG. 22 MM
BGS 5246-H24		INSERTO ESAG. 24 MM
BGS 5246-2		BUSSOLA ATT. 3/4", PORTAINSERTI 22 MM
BGS 5246-1		BUSSOLA ATT. 1", PORTAINSERTI 22 MM

BUSSOLA PORTAINSERTI 22 mm

Koken
articolo

mm	L mm	
16107	60	1

3/4" 22 mm



RICAMBI

DESCRIZIONE	
Koken articolo	GRANO DI RICAMBIO M8X14, ESAGONO 4 MM
16107-SC	

BUSSOLA PORTAINSERTI 22 mm

Koken
articolo

mm	L mm	
18107	70	1

1" 22 mm

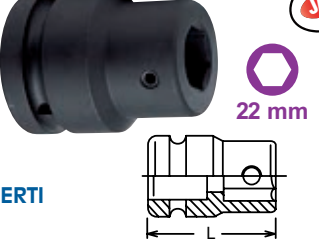

INSERTO CON MASCHIO ESAGONALE

Koken
articolo

mm	L mm	
107-22-17	50	1
107-22-19	50	1
107-22-22	50	1
107-22-24	50	1
107-22-27	50	1
107-22-30	50	1
107-22-32	55	1
107-22-140-17	140	1
107-22-140-19	140	1
107-22-140-22	140	1
107-22-140-24	140	1
POLLICI		
107-22-5/8	50	1
107-22-3/4	50	1
107-22-7/8	50	1
107-22-1	50	1
107-22-1-1/4	55	1

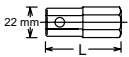



JAPAN

PROLUNGA

Kokon articolo	D mm	FORO	L mm	
18760-175	54	FORO	175	1
18760-200	54	FORO	200	1
18760-250	54	FORO	250	1
18760-330	54	FORO	330	1



JAPAN

SNODO UNIVERSALE

Kokon articolo	L mm	
18770	127	1

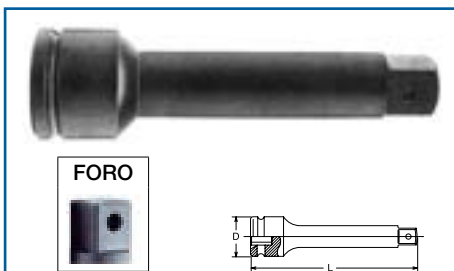

PROLUNGHE PER BUSSOLE "POWER IMPACT" MASCHIO/FEMMINA

FERMEC articolo	FORO	L mm	
97-16-100	FORO	100	1
97-16-125	FORO	125	1
97-16-175	FORO	175	1
97-17	FORO	250	1
97-18	FORO	330	1
97-18-400	FORO	400	1

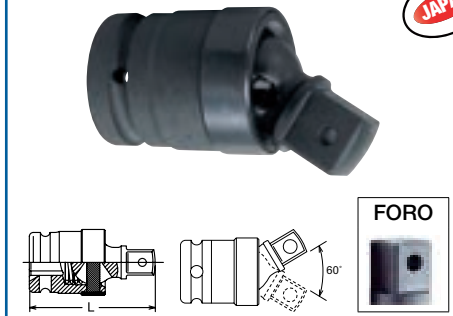

JAPAN

SNODO UNIVERSALE

Kokon articolo	L mm	
18771	115	1



ADATTATORI DOPPIO QUADRO MASCHIO

FERMEC articolo	FORO	L mm
2841	1/4"	20
3841	3/8"	30
4841	1/2"	37
BGS 9623	3/4"	53
8841	1"	68

CARATTERISTICHE

- con doppia sfera

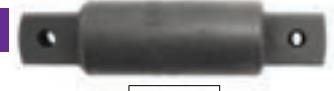

PROLUNGHE PER BUSSOLE "POWER IMPACT" MASCHIO/MASCHIO

FERMEC articolo	B	A	L mm	
Z 0802	1/2"	1/2"	50	1
Z 0803	1/2"	1/2"	76	1
Z 0805	1/2"	1/2"	127	1
Z 0810	1/2"	1/2"	254	1
Z 1203	3/4"	3/4"	78	1
Z 1204	3/4"	3/4"	101	1
Z 1205	3/4"	3/4"	127	1
Z 1207	3/4"	3/4"	177	1
Z 1603	1"	1"	76	1
Z 1604	1"	1"	101	1
Z 1605	1"	1"	127	1
Z 1606	1"	1"	152	1
Z 1616	1"	1"	406	1
Z 2404	1 1/2"	1 1/2"	101	1
Z 2405	1 1/2"	1 1/2"	127	1
Z 4005	2-1/2"	2-1/2"	127	1



RIDUZIONI PER BUSSOLE "POWER IMPACT" FEMMINA/FEMMINA

FERMEC articolo	B	A	L mm	
AN 0808	1/2"	1/2"	33	1
AN 1208	3/4"	1/2"	49	1
AN 1212	3/4"	3/4"	49	1
AN 1612	1"	3/4"	63	1
AN 1616	1"	1"	59	1
AN 2416	1-1/2"	1"	83	1
AN 2424	1 1/2"	1-1/2"	85	1

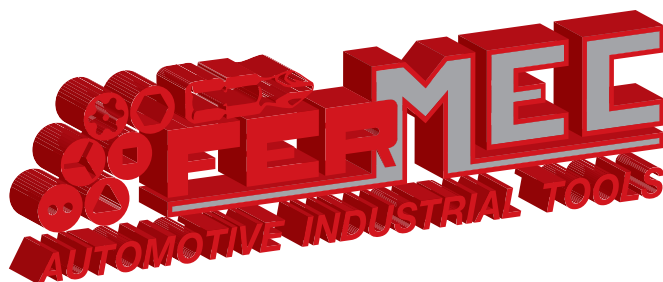



RACCORDI DI RIDUZIONE "POWER IMPACT" MASCHIO/FEMMINA

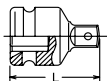

articolo		F	M	L mm	
12233 A-P	PERNO	1/4"	3/8"	22	1
12233 A-B	SFERA	1/4"	3/8"	22	1
12233 A	FORO	1/4"	3/8"	22	1
13322 A-P	PERNO	3/8"	1/4"	27	1
13322 A-B	SFERA	3/8"	1/4"	27	1
13322 A	FORO	3/8"	1/4"	27	1
13344 A-P	PERNO	3/8"	1/2"	32.5	1
13344 A-B	SFERA	3/8"	1/2"	32.5	1
13344 A	FORO	3/8"	1/2"	32.5	1
14433 A-P	PERNO	1/2"	3/8"	37.5	1
14433 A-B	SFERA	1/2"	3/8"	37.5	1
14433 A	FORO	1/2"	3/8"	37.5	1
14455 A	FORO	1/2"	5/8"	42	1
14466 A	FORO	1/2"	3/4"	44	1
14466 A-B	SFERA	1/2"	3/4"	44	1
14466 A-200 B	SFERA	1/2"	3/4"	200	1
14488 A-B	SFERA	1/2"	1"	58	1
14488 A-200 B	SFERA	1/2"	1"	200	1
15544 A-P	PERNO	5/8"	1/2"	46	1
15544 A	FORO	5/8"	1/2"	46	1
15566 A	FORO	5/8"	3/4"	48	1
16644 A-B	PERNO	3/4"	1/2"	54	1
16644 A-P	SFERA	3/4"	1/2"	54	1
16644 A	FORO	3/4"	1/2"	54	1
16655 A	FORO	3/4"	5/8"	55.5	1
16688 A	FORO	3/4"	1"	62	1
16688 A-250	FORO	3/4"	1"	250	1
16688 A-330	FORO	3/4"	1"	330	1
18866 A	FORO	1"	3/4"	66.5	1
18866 A-200	FORO	1"	3/4"	200	1
18877 A	FORO	1"	1-1/2"	80	1
17788 A	FORO	1-1/2"	1"	98	1
17799 A	FORO	1-1/2"	2-1/2"	115	1
19977 A	FORO	2-1/2"	1-1/2"	145	1
10099 A	FORO	3-1/2"	2-1/2"	182	1



RACCORDI DI RIDUZIONE "POWER IMPACT" MASCHIO/FEMMINA

articolo		F	M	L mm	
96-00	PERNO	1/4"	3/8"	32	1
96-0	PERNO	3/8"	1/4"	35	1
96-1	PERNO	3/8"	1/2"	45	1
96-01	PERNO	1/2"	1/4"	38	1
96-2	PERNO	1/2"	3/8"	45	1
96-3	FORO	5/8"	1/2"	50	1
96-4	PERNO	3/4"	1/2"	56	1
96-8	FORO	3/4"	1"	70	1
96-9	FORO	1"	3/4"	70	1
96-10	PERNO	1"	1/2"	70	1
96-11	FORO	1/2"	3/4"	50	1
96-12	FORO	1 1/2"	1"	115	1
96-13	FORO	1"	1 1/2"	115	1
96-14	FORO	2 1/2"	1 1/2"	115	1
96-15	FORO	1 1/2"	2 1/2"	120	1
96-16	FORO	1 1/4"	1"	140	1
96-17	FORO	1 3/4"	1 1/2"	150	1



RACCORDI DI RIDUZIONE "POWER IMPACT" MASCHIO/FEMMINA CON SFERA DI TENUTA NEL QUADRO MASCHIO

articolo		F	M	L mm	
696-00 S		1/4"	3/8"	26	1
696-0 S		3/8"	1/4"	32	1
696-01 S		1/2"	1/4"	36	1
696-1 S		3/8"	1/2"	36	1
696-2 S		1/2"	3/8"	38	1
696-11 S		1/2"	3/4"	48	1
696-4 S		3/4"	1/2"	56	1
696-8 S		3/4"	1"	63	1
696-9 S		1"	3/4"	75	1

ARTICOLO NON SOGGETTO A GARANZIA



articolo	DESCRIZIONE
BGS 200	SET 6 PEZZI, RIDUZIONI A MACCHINA

CARATTERISTICHE

- rivestimento specifico nero opaco
- peso: 880 g

CONTENUTO

- 1/4" F X 3/8" M, coppia massima 60 Nm
- 3/8" F X 1/4" M, coppia massima 60 Nm
- 3/8" F X 1/2" M, coppia massima 200 Nm
- 1/2" F X 3/8" M, coppia massima 200 Nm
- 1/2" F X 3/4" M, coppia massima 500 Nm
- 3/4" F X 1/2" M, coppia massima 500 Nm

RICAMBI

articolo	DESCRIZIONE
BGS 200-LEER	CASSETTA VUOTA



articolo	DESCRIZIONE
BGS 25140	SET 11 PEZZI, RIDUZIONI E SNODI A MACCHINA

CARATTERISTICHE

- rivestimento specifico nero opaco
- peso: 2,6 kg

CONTENUTO

- 1/4" F x 3/8" M
- 3/8" F x 1/4" M
- 3/8" F x 1/2" M
- 1/2" F x 3/8" M
- 1/2" F x 3/4" M
- 3/4" F x 1/2" M
- 3/4" F x 1" M
- 1" F x 3/4" M
- snodi da 1/4", 3/8", 1/2"



SFERA

1/4"-3/8"-1/2"-3/4" 1/4"-3/8"-1/2"-3/4"

RACCORDI DI RIDUZIONE CHROM-VANADIUM

attacco: 1/4" - 3/8" - 1/2" - 3/4"

BGS articolo	FEMMINA	MASCHIO	L mm	Box
BGS 271	1/4"	3/8"	1	
BGS 269	3/8"	1/4"	1	
BGS 280	3/8"	1/2"	1	
BGS 270	1/2"	3/8"	1	
BGS 272	1/2"	3/4"	1	
BGS 274	3/4"	1/2"	1	



RACCORDI DI RIDUZIONE A MANDRINO CON SGANCIO RAPIDO "POWER IMPACT"

FEFMEC articolo	F	M	L mm	Box
691-0 SWF	3/8"	1/4"	55	1
691-1 SWF	3/8"	1/2"	60	1
691-2 SWF	1/2"	3/8"	55	1
691-11 SWF	1/2"	3/4"	75	1
691-4 SWF	3/4"	1/2"	70	1
691-9 SWF	1"	3/4"	90	1

Koken articolo	F	M	L mm	Box
14466 AL	1/2"	3/4"	75	1
16644 AL	3/4"	1/2"	70	1



RACCORDI DI RIDUZIONE MAGNETICI "POWER IMPACT" A SCOMPARSA - SPAZI RIDOTTI

FEFMEC articolo	F	M	L mm	Box
698-00	1/4"	3/8"	17	1
698-0	1/4"	1/2"	22	1
698-1	3/8"	1/2"	22	1
698-11	1/2"	3/4"	30	1
698-8	3/4"	1"	35	1
698-13	1"	1 1/2"	50	1
698-15	1 1/2"	2 1/2"	60	1



SFERA

RACCORDO DI RIDUZIONE MASCHIO/FEMMINA CON SFERA DI TENUTA NEL QUADRO MASCHIO

JAPAN

Koken articolo	F	M	L mm	Box
2233 A	1/4"	3/8"	22	1
3322 A	3/8"	1/4"	24	1
3344 A	3/8"	1/2"	35	1
4433 A-35	1/2"	3/8"	35	1
4433 A-75	1/2"	3/8"	75	1
4433 A-125	1/2"	3/8"	125	1
4433 A-250	1/2"	3/8"	250	1
4433 A-600	1/2"	3/8"	600	1
4466 A	1/2"	3/4"	42	1
6644 A	3/4"	1/2"	47	1
6688 A	3/4"	1"	60	1
8866 A	1"	3/4"	60	1



RACCORDI DI RIDUZIONE MAGNETICI A SCOMPARSA IDEALI PER CHIAVI DINAMOMETRICHE E SPAZI RIDOTTI

FEFMEC articolo	F	M	L mm	Box
1434-1/4	1/4"	3/8"	1	
1434-3/8	3/8"	1/2"	1	
1434-1/2	1/2"	3/4"	1	



SFERA

RIDUZIONI A SCOMPARSA

Koken articolo	F	M	D mm	L mm	Box
2756 Z-3/8	1/4"	3/8"	20.3	21.5	1
2756 Z-1/2	1/4"	1/2"	20.3	26	1
3756 Z-1/2	3/8"	1/2"	28	29	1

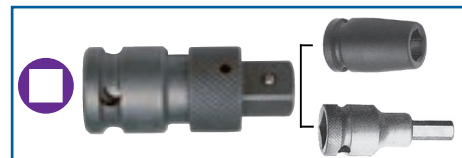

MANDRINO CON SGANCIO RAPIDO PER BUSSELE "POWER IMPACT"

attacco: Quadro femmina impronta: DIN 3126, E 11,2 - E 6,35

FEFMEC articolo	F	M	L mm	Box
195-SWF	1/4"	1/4"	41	1
196-SWF	3/8"	3/8"	46	1
97-3-125 SWF	3/8"	3/8"	125	1
197-SWF	1/2"	1/2"	60	1
199-SWF	3/4"	3/4"	78	1
1991-SWF	1"	1"	100	1

Koken articolo	F	M	L mm	Box
12222 AL	1/4"	1/4"	35	1
13333 AL	3/8"	3/8"	45	1
14444 AL	1/2"	1/2"	55	1
16666 AL	3/4"	3/4"	75	1
18888 AL	1"	1"	95	1

NOTE

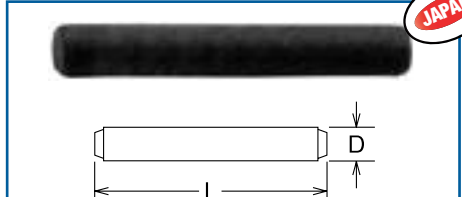

JAPAN

SPINE ACCIAIO PER BUSSOLE

Koken articolo	□	D mm	L mm	☒
A 21	1/4"	1.5	10,2	1
A 31	3/8"	2.5	14,5	1
A 32	3/8"	2.5	17,5	1
A 41	1/2"	3.0	20	1
A 42	1/2"	3.0	25	1
A 51	5/8"	4.0	29	1
A 61	3/4"	4.0	35	1
A 62	3/4"	4.0	45	1
A 81	1"	5.0	45	1
A 82	1"	5.0	57	1
A 83	1"	5.0	75	1
A 71	1 1/2"	6.0	75	1
A 72	1 1/2"	6.0	110	1
A 91	2 1/2"	8.0	110	1
A 92	2 1/2"	8.0	155	1
A 01	3 1/2"	13.0	155	1
A 02	3 1/2"	13.0	180	1

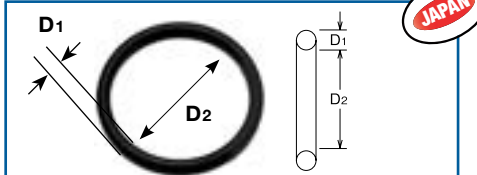

JAPAN

ANELLI DI GOMMA PER BUSSOLE

Koken articolo	□	D 1 mm	D 2 mm	☒
B 21	1/4"	2.5	9	1
B 31	3/8"	3.5	13	1
B 32	3/8"	3.5	16	1
B 41	1/2"	4	19	1
B 42	1/2"	4	24	1
B 51	5/8"	5	28	1
B 61	3/4"	5	36	1
B 62	3/4"	5	45	1
B 81	1"	7	45	1
B 82	1"	7	57	1
B 83	1"	7	75	1
B 71	1 1/2"	10	75	1
B 72	1 1/2"	10	114	1
B 91	2 1/2"	10.5	114	1
B 92	2 1/2"	10.5	158	1
B 01	3 1/2"	15	158	1
B 02	3 1/2"	15	183	1



JAPAN

MOLLA DI SICUREZZA PER BUSSOLE

Koken articolo	□	Ø	L mm	☒
C 31	3/8"	≤ 12	18	1
C 32	3/8"	> 12	20	1
C 41	1/2"	≤ 14	23	1
C 42	1/2"	> 14	26	1
C 61	3/4"	≤ 46	41	1
C 81	1"	≤ 46	50	1
C 82	1"	> 46	1	1
C 83	1"	> 70	1	1
C 71	1 1/2"	≤ 90	1	1



JAPAN

ESTRATTORE PER MOLLE DI SICUREZZA

Koken articolo	□	☒
149	3/8" - 1/2"	1
152	3/4" - 1"	1



JAPAN

SET MOLLE DI SICUREZZA PER BUSSOLE

Koken articolo	☒	☒	☒
nr.			
PKC 31	10	149	1
PKC 32	10	149	1
PKC 41	10	149	1
PKC 42	10	149	1
PKC 61	10	152	1
PKC 81	10	152	1



1-1/2"



ESAGONO

BUSSOLE ESAGONALI

attacco: 1 1/2"

impronta: ESAGONO

FEIMEC articolo	mm	L mm	
1992-30	30	80	1
1992-32	32	80	1
1992-35	35	80	1
1992-36	36	80	1
1992-38	38	80	1
1992-40	40	80	1
1992-41	41	80	1
1992-42	42	80	1
1992-43	43	82	1
1992-44	44	83	1
1992-46	46	84	1
1992-48	48	80	1
1992-50	50	84	1
1992-51	51	84	1
1992-52	52	84	1
1992-54	54	86	1
1992-55	55	90	1
1992-60	60	90	1
1992-65	65	95	1
1992-67	67	95	1
1992-70	70	100	1
1992-73	73	100	1
1992-75	75	105	1
1992-80	80	110	1
1992-85	85	110	1
1992-90	90	115	1
1992-95	95	115	1
1992-100	100	120	1
1992-105	105	120	1
1992-110	110	125	1
1992-115	115	130	1
1992-120	120	135	1
1992-125	125	135	1
1992-130	130	145	1
1992-135	135	145	1
1992-140	140	150	1
1992-145	145	155	1
1992-150	150	160	1
1992-155	155	165	1

POLLICI



1-1/2"



ESAGONO

BUSSOLE ESAGONALI MISURE IN POLLICI

attacco: 1 1/2"

impronta: ESAGONO

FEIMEC articolo	pollici	L mm	
1992-1-5/16	1-5/16"	80	1
1992-1-7/16	1-7/16"	80	1
1992-1-9/16	1-9/16"	80	1
1992-1-11/16	1-11/16"	80	1
1992-1-3/4	1-3/4"	80	1
1992-1-7/8	1-7/8"	82	1
1992-2	2"	82	1
1992-2-1/16	2-1/16"	90	1
1992-2-3/16	2-3/16"	90	1
1992-2-1/4	2-1/4"	90	1
1992-2-5/16	2-5/16"	92	1
1992-2-3/8	2-3/8"	95	1
1992-2-7/16	2-7/16"	95	1
1992-2-1/2	2-1/2"	95	1
1992-2-5/8	2-5/8"	100	1
1992-2-11/16	2-11/16"	100	1
1992-2-13/16	2-13/16"	105	1
1992-2-7/8	2-7/8"	105	1
1992-2-15/16	2-15/16"	110	1
1992-3	3"	110	1
1992-3-1/8	3-1/8"	115	1
1992-3-1/4	3-1/4"	115	1
1992-3-5/16	3-5/16"	115	1
1992-3-3/8	3-3/8"	115	1
1992-3-7/16	3-7/16"	118	1
1992-3-1/2	3-1/2"	118	1
1992-3-11/16	3-11/16"	118	1
1992-3-7/8	3-7/8"	125	1
1992-4	4"	125	1
1992-4-1/16	4-1/16"	125	1
1992-4-1/4	4-1/4"	137	1
1992-4-7/16	4-7/16"	137	1
1992-4-1/2	4-1/2"	137	1
1992-4-5/8	4-5/8"	143	1
1992-5	5"	150	1



1-1/2"



ESAGONO

LUNGHE

attacco: 1 1/2"

impronta: ESAGONO

FEIMEC articolo	mm	L mm	
1992-36 L	36	140	1
1992-38 L	38	140	1
1992-41 L	41	140	1
1992-42 L	42	140	1
1992-43 L	43	140	1
1992-46 L	46	140	1
1992-48 L	48	140	1
1992-50 L	50	140	1
1992-52 L	52	140	1
1992-54 L	54	140	1
1992-55 L	55	140	1
1992-60 L	60	140	1
1992-65 L	65	140	1
1992-70 L	70	140	1
1992-75 L	75	140	1
1992-80 L	80	140	1
1992-85 L	85	140	1
1992-90 L	90	140	1
1992-95 L	95	150	1
1992-100 L	100	150	1
1992-105 L	105	150	1
1992-110 L	110	160	1
1992-115 L	115	160	1
1992-120 L	120	170	1
1992-125 L	125	170	1
1992-130 L	130	185	1



POLLICI

novità



1-1/2"



ESAGONO

CHIAVI A BUSSOLA
A MACCHINA
BOCCA ESAGONALE
TIPO LUNGO

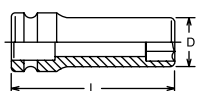

attacco: 1 1/2"
impronta: ESAGONO

Koken articolo	pollici	D mm	L mm	
17300A-1-5/8	1-5/8"	68	115	1
17300A-1-11/16	1-11/16"	71	115	1
17300A-1-3/4	1-3/4"	73	115	1
17300A-1-13/16	1-13/16"	74	125	1
17300A-1-7/8	1-7/8"	77	125	1
17300A-1-15/16	1-15/16"	79	125	1
17300A-2	2"	80	135	1
17300A-2-1/16	2-1/16"	82	135	1
17300A-2-1/8	2-1/8"	84	135	1
17300A-2-3/16	2-3/16"	85	135	1
17300A-2-1/4	2-1/4"	87	135	1
17300A-2-3/8	2-3/8"	91	135	1
17300A-2-7/16	2-7/16"	93	135	1
17300A-2-1/2	2-1/2"	96	135	1
17300A-2-9/16	2-9/16"	97	145	1
17300A-2-5/8	2-5/8"	100	145	1
17300A-2-11/16	2-11/16"	101	145	1
17300A-2-3/4	2-3/4"	103	145	1
17300A-2-13/16	2-13/16"	105	145	1
17300A-2-7/8	2-7/8"	106	145	1
17300A-2-15/16	2-15/16"	108	155	1
17300A-3	3"	108	155	1
17300A-3-1/8	3-1/8"	115	165	1
17300A-3-3/4	3-3/4"	135	175	1
17300A-3-7/8	3-7/8"	140	175	1



1-1/2"



POLIGONALE

BUSSOLE POLIGONALI

attacco: 1 1/2"
impronta: POLIGONALE

articolo	mm	L mm	
1992-36 DSKT	36	80	1
1992-38 DSKT	38	80	1
1992-41 DSKT	41	80	1
1992-46 DSKT	46	80	1
1992-50 DSKT	50	82	1
1992-55 DSKT	55	90	1
1992-60 DSKT	60	90	1
1992-65 DSKT	65	96	1
1992-70 DSKT	70	100	1
1992-75 DSKT	75	105	1
1992-80 DSKT	80	110	1
1992-85 DSKT	85	116	1
1992-90 DSKT	90	118	1
1992-95 DSKT	95	118	1
1992-100 DSKT	100	125	1
1992-105 DSKT	105	125	1
1992-110 DSKT	110	137	1
1992-115 DSKT	115	137	1
1992-120 DSKT	120	145	1
1992-125 DSKT	125	145	1
1992-130 DSKT	130	150	1

POLLICI



1-1/2"



POLIGONALE

BUSSOLE POLIGONALI MISURE IN POLLICI

attacco: 1 1/2"
impronta: POLIGONALE

articolo	pollici	L mm	
1992-1-3/8 DSKT	1-3/8"	75	1
1992-1-7/16 DSKT	1-7/16"	80	1
1992-1-9/16 DSKT	1-9/16"	80	1
1992-1-11/16 DSKT	1-11/16"	80	1
1992-1-3/4 DSKT	1-3/4"	80	1
1992-1-7/8 DSKT	1-7/8"	80	1
1992-1-15/16 DSKT	1-15/16"	80	1
1992-2 DSKT	2"	80	1
1992-2-1/16 DSKT	2-1/16"	90	1
1992-2-1/8 DSKT	2-1/8"	90	1
1992-2-3/16 DSKT	2-3/16"	90	1
1992-2-1/4 DSKT	2-1/4"	90	1
1992-2-5/16 DSKT	2-5/16"	90	1
1992-2-3/8 DSKT	2-3/8"	96	1
1992-2-7/16 DSKT	2-7/16"	96	1
1992-2-1/2 DSKT	2-1/2"	96	1
1992-2-5/8 DSKT	2-5/8"	100	1
1992-2-11/16 DSKT	2-11/16"	100	1
1992-2-13/16 DSKT	2-13/16"	105	1
1992-2-7/8 DSKT	2-7/8"	105	1
1992-3 DSKT	3"	110	1
1992-3-1/8 DSKT	3-1/8"	115	1
1992-3-1/4 DSKT	3-1/4"	116	1
1992-3-1/2 DSKT	3-1/2"	118	1



IMPACT 1-1/2"

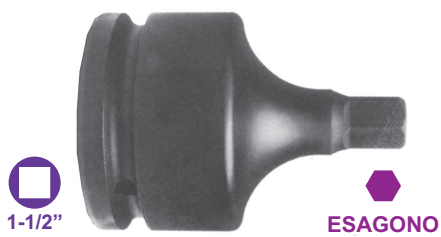

1-1/2"

ESAGONO

BUSSOLE ESAGONALI MASCHIO BRUNITE INTEGRALI CON FORO NEL QUADRO PER SPINA E ANELLO

attacco: 1 1/2"

impronta: ESAGONO

FEIMEC articolo	mm	L mm	
182 - 1-1/2" - 22	22	120	1
182 - 1-1/2" - 24	24	120	1
182 - 1-1/2" - 27	27	120	1
182 - 1-1/2" - 30	30	120	1
182 - 1-1/2" - 32	32	120	1
182 - 1-1/2" - 36	36	120	1
182 - 1-1/2" - 41	41	120	1
182 - 1-1/2" - 46	46	120	1
182 - 1-1/2" - 50	50	120	1
182 - 1-1/2" - 55	55	120	1



32 mm.

ESAGONO

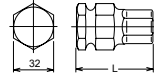

INSERTO CON MASCHIO ESAGONALE

attacco: 32 mm

impronta: ESAGONO

Koken articolo	mm	L mm	
107-32-19	19	60	1
107-32-22	22	60	1
107-32-24	24	60	1
107-32-27	27	60	1
107-32-30	30	60	1
107-32-32	32	60	1
107-32-36	36	60	1



1-1/2"

FORO

1-1/2"

PROLUNGA

attacco: 1 1/2"

Koken articolo	L mm	
17760-175	175	1
17760-250	250	1
17760-330	330	1



1-1/2"

32 mm

16107-SC



BUSOLA PORTAINSERTI 32 mm

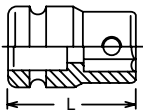

Koken articolo	mm	L mm	
17108	32	85	1

RICAMBI

Koken articolo	DESCRIZIONE
16107-SC	GRANO DI RICAMBIO M8X14, ESAGONO 4 MM



ESAGONO

BUSOLA MASCHIO ESAGONALE IN DUE

PARTI:

BUSOLA + INSERTO MASCHIO ESAGONALE

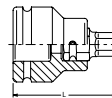

Koken articolo	mm	L mm	
17108-32-19	19	115	1
17108-32-22	22	115	1
17108-32-24	24	115	1
17108-32-27	27	115	1
17108-32-30	30	115	1
17108-32-32	32	115	1
17108-32-36	36	115	1



1-1/2"

FORO

1-1/2"

PROLUNGA

attacco: 1 1/2"

Koken articolo	L mm	
17770	200	1

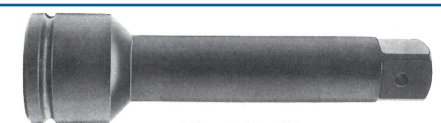

1-1/2"

FORO

1-1/2"

PROLUNGHE PER BUSSOLE "POWER IMPACT" MASCHIO/FEMMINA

attacco: 1 1/2"

FEIMEC articolo	L mm	
97-19	150	1
97-19-175 <i>novità</i>	175	1
97-20	250	1
97-22	500	1



ADATTATORI DOPPIO QUADRO MASCHIO

FEIMEC articolo		L mm
2841	1/4"	20
3841	3/8"	30
4841	1/2"	37
BGS 9623	3/4"	53
8841	1"	68

CARATTERISTICHE

- con doppia sfera

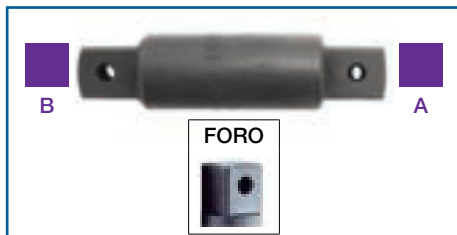

**PROLUNGHE PER BUSSOLE
"POWER IMPACT" MASCHIO/MASCHIO**

articolo	B	A	L mm	
Z 0802	1/2"	1/2"	50	1
Z 0803	1/2"	1/2"	76	1
Z 0805	1/2"	1/2"	127	1
Z 0810	1/2"	1/2"	254	1
Z 1203	3/4"	3/4"	78	1
Z 1204	3/4"	3/4"	101	1
Z 1205	3/4"	3/4"	127	1
Z 1207	3/4"	3/4"	177	1
Z 1603	1"	1"	76	1
Z 1604	1"	1"	101	1
Z 1605	1"	1"	127	1
Z 1606	1"	1"	152	1
Z 1616	1"	1"	406	1
Z 2404	1 1/2"	1 1/2"	101	1
Z 2405	1 1/2"	1 1/2"	127	1
Z 4005	2-1/2"	2-1/2"	127	1



**RIDUZIONI PER BUSSOLE
"POWER IMPACT" FEMMINA/FEMMINA**

articolo	B	A	L mm	
AN 0808	1/2"	1/2"	33	1
AN 1208	3/4"	1/2"	49	1
AN 1212	3/4"	3/4"	49	1
AN 1612	1"	3/4"	63	1
AN 1616	1"	1"	59	1
AN 2416	1-1/2"	1"	83	1
AN 2424	1 1/2"	1-1/2"	85	1



**RACCORDI DI RIDUZIONE
"POWER IMPACT"
MASCHIO/FEMMINA**

articolo		F	M	L mm	
12233 A-P	PERNO	1/4"	3/8"	22	1
12233 A-B	SFERA	1/4"	3/8"	22	1
12233 A	FORO	1/4"	3/8"	22	1
13322 A-P	PERNO	3/8"	1/4"	27	1
13322 A-B	SFERA	3/8"	1/4"	27	1
13322 A	FORO	3/8"	1/4"	27	1
13344 A-P	PERNO	3/8"	1/2"	32.5	1
13344 A-B	SFERA	3/8"	1/2"	32.5	1
13344 A	FORO	3/8"	1/2"	32.5	1
14433 A-P	PERNO	1/2"	3/8"	37.5	1
14433 A-B	SFERA	1/2"	3/8"	37.5	1
14433 A	FORO	1/2"	3/8"	37.5	1
14455 A	FORO	1/2"	5/8"	42	1
14466 A	FORO	1/2"	3/4"	44	1
14466 A-B	SFERA	1/2"	3/4"	44	1
14466 A-200 B	SFERA	1/2"	3/4"	200	1
14488 A-B	SFERA	1/2"	1"	58	1
14488 A-200 B	SFERA	1/2"	1"	200	1
15544 A-P	PERNO	5/8"	1/2"	46	1
15544 A	FORO	5/8"	1/2"	46	1
15566 A	FORO	5/8"	3/4"	48	1
16644 A-B	PERNO	3/4"	1/2"	54	1
16644 A-P	SFERA	3/4"	1/2"	54	1
16644 A	FORO	3/4"	1/2"	54	1
16655 A	FORO	3/4"	5/8"	55.5	1
16688 A	FORO	3/4"	1"	62	1
16688 A-250	FORO	3/4"	1"	250	1
16688 A-330	FORO	3/4"	1"	330	1
18866 A	FORO	1"	3/4"	66.5	1
18866 A-200	FORO	1"	3/4"	200	1
18877 A	FORO	1"	1-1/2"	80	1
17788 A	FORO	1-1/2"	1"	98	1
17799 A	FORO	1-1/2"	2-1/2"	115	1
19977 A	FORO	2-1/2"	1-1/2"	145	1
10099 A	FORO	3-1/2"	2-1/2"	182	1



RACCORDI DI RIDUZIONE "POWER IMPACT" MASCHIO/FEMMINA

articolo		F	M	L mm	
96-00	PERNO	1/4"	3/8"	32	1
96-0	PERNO	3/8"	1/4"	35	1
96-1	PERNO	3/8"	1/2"	45	1
96-01	PERNO	1/2"	1/4"	38	1
96-2	PERNO	1/2"	3/8"	45	1
96-3	FORO	5/8"	1/2"	50	1
96-4	PERNO	3/4"	1/2"	56	1
96-8	FORO	3/4"	1"	70	1
96-9	FORO	1"	3/4"	70	1
96-10	PERNO	1"	1/2"	70	1
96-11	FORO	1/2"	3/4"	50	1
96-12	FORO	1 1/2"	1"	115	1
96-13	FORO	1"	1 1/2"	115	1
96-14	FORO	2 1/2"	1 1/2"	115	1
96-15	FORO	1 1/2"	2 1/2"	120	1
96-16	FORO	1 1/4"	1"	140	1
96-17	FORO	1 3/4"	1 1/2"	150	1

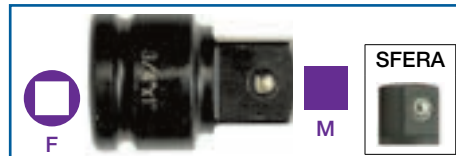

**RACCORDI DI RIDUZIONE "POWER IMPACT" MASCHIO/FEMMINA
CON SFERA DI TENUTA NEL QUADRO MASCHIO**

articolo	F	M	L mm	
696-00 S	1/4"	3/8"	26	1
696-0 S	3/8"	1/4"	32	1
696-01 S	1/2"	1/4"	36	1
696-1 S	3/8"	1/2"	36	1
696-2 S	1/2"	3/8"	38	1
696-11 S	1/2"	3/4"	48	1
696-4 S	3/4"	1/2"	56	1
696-8 S	3/4"	1"	63	1
696-9 S	1"	3/4"	75	1



**ARTICOLO NON
SOGGETTO A
GARANZIA**



BGS articolo	DESCRIZIONE	
BGS 200	SET 6 PEZZI, RIDUZIONI A MACCHINA	

CARATTERISTICHE

- rivestimento specifico nero opaco
- peso 880 g

CONTENUTO

- 1/4" F X 3/8" M, coppia massima 60 Nm
- 3/8" F X 1/4" M, coppia massima 60 Nm
- 3/8" F X 1/2" M, coppia massima 200 Nm
- 1/2" F X 3/8" M, coppia massima 200 Nm
- 1/2" F X 3/4" M, coppia massima 500 Nm
- 3/4" F X 1/2" M, coppia massima 500 Nm

RICAMBI

BGS articolo	DESCRIZIONE	
BGS 200-LEER	CASSETTA VUOTA	



BGS articolo	DESCRIZIONE	
BGS 25140	SET 11 PEZZI, RIDUZIONI E SNODI A MACCHINA	

CARATTERISTICHE

- rivestimento specifico nero opaco
- peso 2,6 kg

CONTENUTO

- 1/4" F x 3/8" M
- 3/8" F x 1/4" M
- 3/8" F x 1/2" M
- 1/2" F x 3/8" M
- 1/2" F x 3/4" M
- 3/4" F x 1/2" M
- 3/4" F x 1" M
- 1" F x 3/4" M
- snodi da 1/4", 3/8", 1/2"



1/4"-3/8"-1/2"-3/4" 1/4"-3/8"-1/2"-3/4"

RACCORDI DI RIDUZIONE CHROM-VANADIUM

attacco: 1/4" - 3/8" - 1/2" - 3/4"

BGS articolo	FEMMINA	MASCHIO	L mm	Q 1
BGS 271	1/4"	3/8"	55	1
BGS 269	3/8"	1/4"	60	1
BGS 280	3/8"	1/2"	75	1
BGS 270	1/2"	3/8"	70	1
BGS 272	1/2"	3/4"	90	1
BGS 274	3/4"	1/2"	70	1



RACCORDO DI RIDUZIONE MASCHIO/FEMMINA CON SFERA DI TENUTA NEL QUADRO MASCHIO

Kokon articolo	F	M	L mm	Q 1
2233 A	1/4"	3/8"	22	1
3322 A	3/8"	1/4"	24	1
3344 A	3/8"	1/2"	35	1
4433 A-35	1/2"	3/8"	35	1
4433 A-75	1/2"	3/8"	75	1
4433 A-125	1/2"	3/8"	125	1
4433 A-250	1/2"	3/8"	250	1
4433 A-600	1/2"	3/8"	600	1
4466 A	1/2"	3/4"	42	1
6644 A	3/4"	1/2"	47	1
6688 A	3/4"	1"	60	1
8866 A	1"	3/4"	60	1



RACCORDI DI RIDUZIONE A MANDRINO CON SGANCIO RAPIDO "POWER IMPACT"

FERMEC articolo	F	M	L mm	Q 1
691-0 SWF	3/8"	1/4"	55	1
691-1 SWF	3/8"	1/2"	60	1
691-2 SWF	1/2"	3/8"	55	1
691-11 SWF	1/2"	3/4"	75	1
691-4 SWF	3/4"	1/2"	70	1
691-9 SWF	1"	3/4"	90	1
Koken				
14466 AL	1/2"	3/4"	75	1
16644 AL	3/4"	1/2"	70	1

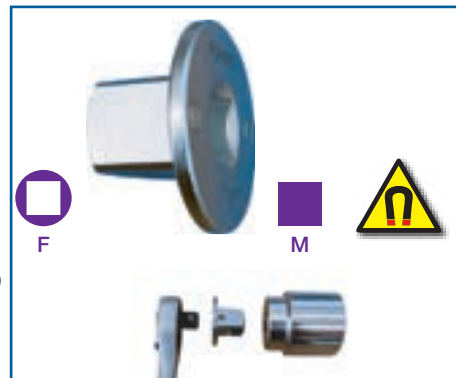

RACCORDI DI RIDUZIONE MAGNETICI A SCOMPARSA IDEALI PER CHIAVI DINAMOMETRICHE E SPAZI RIDOTTI

FERMEC articolo	F	M	L mm	Q 1
1434-1/4	1/4"	3/8"	22	1
1434-3/8	3/8"	1/2"	24	1
1434-1/2	1/2"	3/4"	35	1



RIDUZIONI A SCOMPARSA CON SFERA NEL QUADRO MASCHIO

Kokon articolo	F	M	D mm	L mm	Q 1
2756 Z-3/8	1/4"	3/8"	20.3	21.5	1
2756 Z-1/2	1/4"	1/2"	20.3	26	1
3756 Z-1/2	3/8"	1/2"	28	29	1



**RACCORDI DI RIDUZIONE MAGNETICI
"POWER IMPACT"
A SCOMPARSA - SPAZI RIDOTTI**

articolo	F	M	L mm	
698-00	1/4"	3/8"	17	1
698-0	1/4"	1/2"	22	1
698-1	3/8"	1/2"	22	1
698-11	1/2"	3/4"	30	1
698-8	3/4"	1"	35	1
698-13	1"	1 1/2"	50	1
698-15	1 1/2"	2 1/2"	60	1

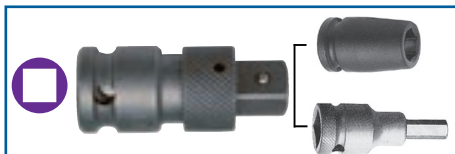

**MANDRINO CON SGANCIO RAPIDO PER
BUSSELE "POWER IMPACT"**

attacco: Quadro femmina
impronta: DIN 3126, E 11,2 - E 6,35

articolo	F	M	L mm	
195-SWF	1/4"	1/4"	41	1
196-SWF	3/8"	3/8"	46	1
97-3-125 SWF	3/8"	3/8"	125	1
197-SWF	1/2"	1/2"	60	1
199-SWF	3/4"	3/4"	78	1
1991-SWF	1"	1"	100	1
Koken				
12222 AL	1/4"	1/4"	35	1
13333 AL	3/8"	3/8"	45	1
14444 AL	1/2"	1/2"	55	1
16666 AL	3/4"	3/4"	75	1
18888 AL	1"	1"	95	1

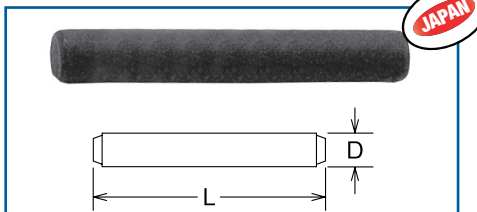

SPINE ACCIAIO PER BUSSELE

articolo	F	D mm	L mm	
A 21	1/4"	1.5	10,2	1
A 31	3/8"	2.5	14,5	1
A 32	3/8"	2.5	17,5	1
A 41	1/2"	3.0	20	1
A 42	1/2"	3.0	25	1
A 51	5/8"	4.0	29	1
A 61	3/4"	4.0	35	1
A 62	3/4"	4.0	45	1
A 81	1"	5.0	45	1
A 82	1"	5.0	57	1
A 83	1"	5.0	75	1
A 71	1 1/2"	6.0	75	1
A 72	1 1/2"	6.0	110	1
A 91	2 1/2"	8.0	110	1
A 92	2 1/2"	8.0	155	1
A 01	3 1/2"	13.0	155	1
A 02	3 1/2"	13.0	180	1

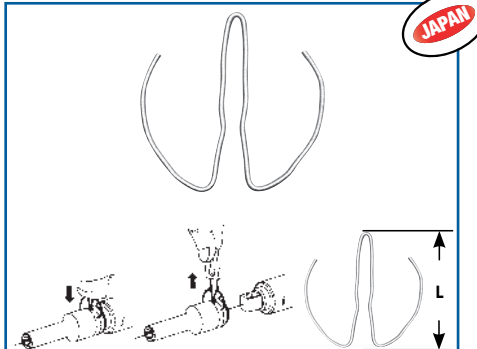

MOLLA DI SICUREZZA PER BUSSELE

articolo	F	Ø	L mm	
C 31	3/8"	≤ 12	18	1
C 32	3/8"	> 12	20	1
C 41	1/2"	≤ 14	23	1
C 42	1/2"	> 14	26	1
C 61	3/4"	≤ 46	41	1
C 81	1"	≤ 46	50	1
C 82	1"	> 46		1
C 83	1"	> 70		1
C 71	1 1/2"	≤ 90		1

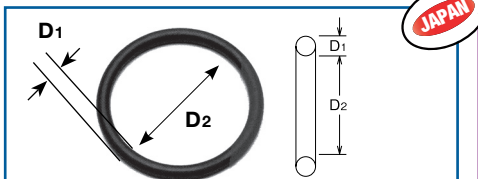

ANELLI DI GOMMA PER BUSSELE

articolo	F	D 1 mm	D 2 mm	
B 21	1/4"	2.5	9	1
B 31	3/8"	3.5	13	1
B 32	3/8"	3.5	16	1
B 41	1/2"	4	19	1
B 42	1/2"	4	24	1
B 51	5/8"	5	28	1
B 61	3/4"	5	36	1
B 62	3/4"	5	45	1
B 81	1"	7	45	1
B 82	1"	7	57	1
B 83	1"	7	75	1
B 71	1 1/2"	10	75	1
B 72	1 1/2"	10	114	1
B 91	2 1/2"	10.5	114	1
B 92	2 1/2"	10.5	158	1
B 01	3 1/2"	15	158	1
B 02	3 1/2"	15	183	1



ESTRATTORE PER MOLLE DI SICUREZZA

articolo	F	
149	3/8" - 1/2"	1
152	3/4" - 1"	1



SET MOLLE DI SICUREZZA PER BUSSELE

articolo	nr.	
PKC 31	10	149
PKC 32	10	149
PKC 41	10	149
PKC 42	10	149
PKC 61	10	152
PKC 81	10	152

MOLLE-SPINE-ANELLI



**A RICHIESTA
BUSSOLE CON
ATTACCO
3-1/2"
MISURE
METRICHE ED
IN POLLICI**



2-1/2"



ESAGONO

BUSSOLE ESAGONALI

attacco: 2 1/2"

impronta: ESAGONO

FEEMEC articolo	mm	L mm	
1993-46	46	125	1
1993-50	50	125	1
1993-55	55	125	1
1993-60	60	125	1
1993-65	65	125	1
1993-70	70	125	1
1993-75	75	125	1
1993-80	80	125	1
1993-85	85	132	1
1993-90	90	132	1
1993-95	95	140	1
1993-100	100	142	1
1993-105	105	146	1
1993-110	110	155	1
1993-115	115	158	1
1993-120	120	160	1
1993-125	125	165	1
1993-130	130	169	1
1993-135	135	175	1
1993-140	140	180	1
1993-145	145	183	1
1993-150	150	192	1
1993-155	155	196	1
1993-160	160	200	1
1993-165	165	204	1
1993-170	170	207	1
1993-175	175	211	1
1993-180	180	214	1
1993-185	185	218	1
1993-190	190	220	1
1993-200	200	225	1
1993-210	210	235	1

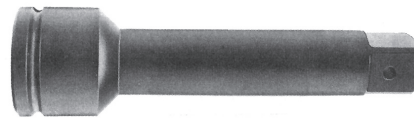

2-1/2"

FORO



2-1/2"

PROLUNGHE PER BUSSOLE "POWER
IMPACT" MASCHIO/FEMMINA

attacco: 2 1/2"

FEEMEC articolo	M	F	L mm	
97-23	2-1/2"	2-1/2"	250	1
97-25	2-1/2"	2-1/2"	500	1



2-1/2"



2-1/2"

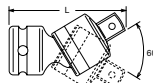

FORO



SNODO A CARDANO "POWER IMPACT"

attacco: 2 1/2"

Kokon articolo	M	F	L mm	
19770	2-1/2"	2-1/2"	303	1





**ARTICOLO NON
SOGGETTO A
GARANZIA**

**A RICHIESTA
MISURE IN
POLLICI E
LUNGHE
METRICHE**



**PROLUNG PER BUSSOLE
"POWER IMPACT" MASCHIO/MASCHIO**

FE#MEC articolo	B	A	L mm	
Z 0802	1/2"	1/2"	50	1
Z 0803	1/2"	1/2"	76	1
Z 0805	1/2"	1/2"	127	1
Z 0810	1/2"	1/2"	254	1
Z 1203	3/4"	3/4"	78	1
Z 1204	3/4"	3/4"	101	1
Z 1205	3/4"	3/4"	127	1
Z 1207	3/4"	3/4"	177	1
Z 1603	1"	1"	76	1
Z 1604	1"	1"	101	1
Z 1605	1"	1"	127	1
Z 1606	1"	1"	152	1
Z 1616	1"	1"	406	1
Z 2404	1 1/2"	1 1/2"	101	1
Z 2405	1 1/2"	1 1/2"	127	1
Z 4005	2-1/2"	2-1/2"	127	1



**RACCORDI DI RIDUZIONE
"POWER IMPACT"
MASCHIO/FEMMINA**

Kokon

articolo		F	M	L mm	
12233 A-P	PERNO	1/4"	3/8"	22	1
12233 A-B	SFERA	1/4"	3/8"	22	1
12233 A	FORO	1/4"	3/8"	22	1
⚠13322 A-P	PERNO	3/8"	1/4"	27	1
⚠13322 A-B	SFERA	3/8"	1/4"	27	1
⚠13322 A	FORO	3/8"	1/4"	27	1
13344 A-P	PERNO	3/8"	1/2"	32.5	1
13344 A-B	SFERA	3/8"	1/2"	32.5	1
13344 A	FORO	3/8"	1/2"	32.5	1
⚠14433 A-P	PERNO	1/2"	3/8"	37.5	1
⚠14433 A-B	SFERA	1/2"	3/8"	37.5	1
⚠14433 A	FORO	1/2"	3/8"	37.5	1
14455 A	FORO	1/2"	5/8"	42	1
14466 A	FORO	1/2"	3/4"	44	1
14466 A-B	SFERA	1/2"	3/4"	44	1
14466 A-200 B	SFERA	1/2"	3/4"	200	1
14488 A-B	SFERA	1/2"	1"	58	1
14488 A-200 B	SFERA	1/2"	1"	200	1
⚠15544 A-P	PERNO	5/8"	1/2"	46	1
⚠15544 A	FORO	5/8"	1/2"	46	1
15566 A	FORO	5/8"	3/4"	48	1
⚠16644 A-B	PERNO	3/4"	1/2"	54	1
⚠16644 A-P	SFERA	3/4"	1/2"	54	1
⚠16644 A	FORO	3/4"	1/2"	54	1
⚠16655 A	FORO	3/4"	5/8"	55.5	1
16688 A	FORO	3/4"	1"	62	1
16688 A-250	FORO	3/4"	1"	250	1
16688 A-330	FORO	3/4"	1"	330	1
⚠18866 A	FORO	1"	3/4"	66.5	1
⚠18866 A-200	FORO	1"	3/4"	200	1
18877 A	FORO	1"	1-1/2"	80	1
⚠17788 A	FORO	1-1/2"	1"	98	1
17799 A	FORO	1-1/2"	2-1/2"	115	1
⚠19977 A	FORO	2-1/2"	1-1/2"	145	1
⚠10099 A	FORO	3-1/2"	2-1/2"	182	1



**RACCORDI DI RIDUZIONE MAGNETICI
"POWER IMPACT"
A SCOMPARSA - SPAZI RIDOTTI**

FE#MEC articolo	F	M	L mm	
698-00	1/4"	3/8"	17	1
698-0	1/4"	1/2"	22	1
698-1	3/8"	1/2"	22	1
698-11	1/2"	3/4"	30	1
698-8	3/4"	1"	35	1
698-13	1"	1 1/2"	50	1
698-15	1 1/2"	2 1/2"	60	1

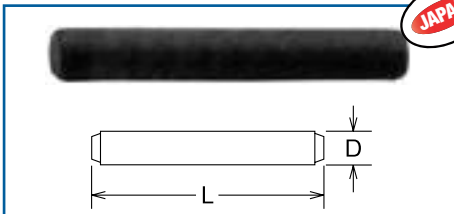

JAPAN

SPINE ACCIAIO PER BUSSOLE

Kokken articolo	Ø	D mm	L mm	Box
A 21	1/4"	1.5	10,2	1
A 31	3/8"	2.5	14,5	1
A 32	3/8"	2.5	17,5	1
A 41	1/2"	3.0	20	1
A 42	1/2"	3.0	25	1
A 51	5/8"	4.0	29	1
A 61	3/4"	4.0	35	1
A 62	3/4"	4.0	45	1
A 81	1"	5.0	45	1
A 82	1"	5.0	57	1
A 83	1"	5.0	75	1
A 71	1 1/2"	6.0	75	1
A 72	1 1/2"	6.0	110	1
A 91	2 1/2"	8.0	110	1
A 92	2 1/2"	8.0	155	1
A 01	3 1/2"	13.0	155	1
A 02	3 1/2"	13.0	180	1

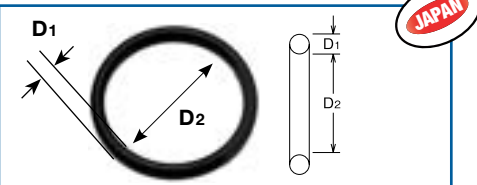

JAPAN

ANELLI DI GOMMA PER BUSSOLE

Kokken articolo	Ø	D 1 mm	D 2 mm	Box
B 21	1/4"	2.5	9	1
B 31	3/8"	3.5	13	1
B 32	3/8"	3.5	16	1
B 41	1/2"	4	19	1
B 42	1/2"	4	24	1
B 51	5/8"	5	28	1
B 61	3/4"	5	36	1
B 62	3/4"	5	45	1
B 81	1"	7	45	1
B 82	1"	7	57	1
B 83	1"	7	75	1
B 71	1 1/2"	10	75	1
B 72	1 1/2"	10	114	1
B 91	2 1/2"	10.5	114	1
B 92	2 1/2"	10.5	158	1
B 01	3 1/2"	15	158	1
B 02	3 1/2"	15	183	1

NOTE

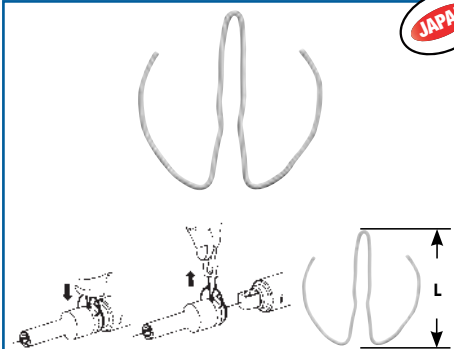

JAPAN

MOLLA DI SICUREZZA PER BUSSOLE

Kokken articolo	Ø	Ø	L mm	Box
C 31	3/8"	≤ 12	18	1
C 32	3/8"	> 12	20	1
C 41	1/2"	≤ 14	23	1
C 42	1/2"	> 14	26	1
C 61	3/4"	≤ 46	41	1
C 81	1"	≤ 46	50	1
C 82	1"	> 46		1
C 83	1"	> 70		1
C 71	1 1/2"	≤ 90		1



JAPAN

ESTRATTORE PER MOLLE DI SICUREZZA

Kokken articolo	Ø	Box
149	3/8" - 1/2"	1
152	3/4" - 1"	1



JAPAN

SET MOLLE DI SICUREZZA PER BUSSOLE

Kokken articolo	nr.	nr.	Box
PKC 31	10	149	1
PKC 32	10	149	1
PKC 41	10	149	1
PKC 42	10	149	1
PKC 61	10	152	1
PKC 81	10	152	1