





















INSERTI

PAG	178	MAGNETI	
PAG	179	TAGLIO	
PAG	180	PHILLIPS	
PAG	182	PHILLIPS+TAGLIO	
PAG	183	POZIDRIV	
PAG	184	POZIDRIV+TAGLIO	
PAG	185	BRUGOLA	
PAG	186	BRUGOLA CON FORO	
PAG	187	TORX	
PAG	189	TORX CON FORO	
PAG	189	TORX PLUS	
PAG	190	PENTALOBATI CON FORO	
PAG	190	ASSY TIPO WURTH	
PAG	190	SPANNER	
PAG	190	RIBE	
PAG	191	TRI-WING	
PAG	191	TORQ-SET	
PAG	191	QUADRO	
PAG	191	TRIANGOLARI	
PAG	191	XZN	
PAG	a richiesta	INSERTI LocTec®	
PAG	192	INSERTI DOPPIA PUNTA	
PAG	193	INSERTI 5/16"	
PAG	195	INSERTI 10-14 MM	
PAG	202	INSERTI ATTACCO FILETTATO	
PAG	205	INSERTI DESOUTTER 5/16"	
PAG	206	INSERTI BOSCH 7/16"	
PAG	208	CHIAVI A BUSSOLA	
PAG	215	PROGRAMMA IN BLISTER	
PAG	216	BOX INSERTI	
PAG	223	BOX MICRO-INSERTI	
PAG	225	BOX INSERTI LUNGHI	
PAG	227	ESPOSITORE INSERTI	

Per magnetizzare inserti e cacciaviti con semplice inserimento della lama nel foro della rondella

RONDELLA MAGNETICA

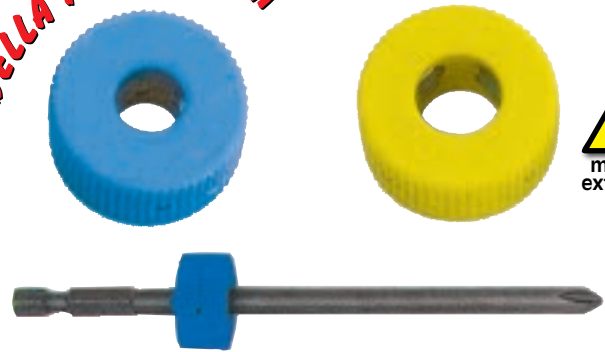

PER SMAGNETIZZARE FARE SCORRERE LA LAMA A CONTATTO CON L'ESTERNO DELLA RONDELLA

FEARMEC articolo	Descrizione	Dimensioni esterne della rondella mm	
MAG. 6	RONDELLA MAGNETICA PER INSERTI E LAME CACCIAVITE FINO Ø 6,5 - BLU	Ø 19 X 10 H	1
MAG. 8	RONDELLA MAGNETICA PER INSERTI E LAME CACCIAVITE FINO Ø 8 - GIALLA	Ø 19 X 10 H	1



BGS articolo BGS 9560	DESCRIZIONE MAGNETE
---------------------------------	--------------------------------------

CARATTERISTICHE

- per magnetizzare punte di cacciaviti, utensili e piccole parti ferrose
- viti e altre piccole parti ferrose saranno attratti senza problemi allo strumento grazie al magnete
- consente di magnetizzare e smagnetizzare facilmente
- peso 90 g



BGS articolo BGS 9561	DESCRIZIONE MAGNETE
---------------------------------	--------------------------------------

CARATTERISTICHE

- per magnetizzare punte di cacciaviti, utensili e piccole parti ferrose
- viti e altre piccole parti ferrose saranno attratti senza problemi allo strumento grazie al magnete
- consente di magnetizzare e smagnetizzare facilmente
- peso 30 g



INSERTO NELLA LAMA DEL CACCIAVITE
MAX Ø 6 MM MIN Ø 4 MM TRATTIENE LE
VITI CON UN MAGNETE IN TESTA

FEARMEC articolo BIG FLEXI	Descrizione MAGNETE PER LAME CACCIAVITI	
--------------------------------------	---	--

Inserti Taglio



 C 6,35
 E 6,35

GERMANY



ESAGONO
1/4" C

INSERTI A TAGLIO

attacco: DIN 3126, C 6,35
impronta: 5264-C

articolo	mm	L mm	
112000	0,5 x 3	25	10
112002	0,6 x 3,5	25	10
112001	0,5 x 4	25	10
112004	0,8 x 4	25	10
112003	0,6 x 4,5	25	10
112005	0,8 x 5,5	25	10
112006	1 x 5,5	25	10
112007	1,2 x 6,5	25	10
112008	1,2 x 8	25	10
112009	1,6 x 8	25	10
12007	1,6 x 10	25	10

GERMANY



ESAGONO
1/4" E

INSERTI A TAGLIO

attacco: DIN 3126, E 6,35
impronta: DIN 5264-C

articolo	mm	L mm	
113000	0,4 x 2	50	5
113001	0,4 x 2,5	50	5
113002	0,5 x 3	50	5
113004	0,6 x 3,5	50	5
113006	0,8 x 4	50	5
113005	0,6 x 4,5	50	5
13006	0,8 x 5,5	50	5
113008	1 x 5,5	50	5
13007	1 x 6	50	5
113009	1,2 x 6,5	50	5
13009	1,2 x 8	50	5
113012	1,6 x 10	50	5
28290	0,5 x 3,0	70	5
28291	0,6 x 3,5	70	5
28292	0,8 x 4,0	70	5
28293	0,6 x 4,5	70	5
28294	0,8 x 5,5	70	5
28295	1,0 x 5,5	70	5
28296	1,2 x 6,5	70	5
28297	1,2 x 8,0	70	5
28299	0,5 x 3,0	75	5
28300	0,5 x 3,0	90	5
28301	0,6 x 3,5	90	5
28302	0,8 x 4,0	90	5
28303	0,6 x 4,5	90	5
28304	1,0 x 5,5	90	5
28305	1,2 x 6,5	90	5
28307	1,2 x 8,0	90	5
28308	1,6 x 8,0	90	5

GERMANY



ESAGONO
1/4" C

INSERTI A TAGLIO

attacco: DIN 3126, C 6,35
impronta: 5264-C

articolo	mm	L mm	
112010	0,5 x 3	39	10
112011	0,6 x 3,5	39	10
112012	0,5 x 4	39	10
112014	0,8 x 4	39	10
112013	0,6 x 4,5	39	10
112015	0,8 x 5,5	39	10
112016	1 x 5,5	39	10
112017	1,2 x 6,5	39	10
112018	1,2 x 8	39	10
112019	1,6 x 8	39	10

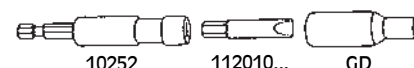

BUSSOLE GUIDA PER VITI A TAGLIO DA USARE SU PORTA INSERTI Ø 11 CON SCARICO E INSERTI A TAGLIO L. MM 39

articolo	mm	Ø testa vite mm	L mm	
GD 142,8	2,8	da 2,9 a 3,5	47	1
GD 143,1	3	da 3,2 a 4	47	1
GD 143,5	3,5	da 3,6 a 4,5	47	1
GD 143,9	4	da 3,9 a 5	47	1
GD 144,2	4,2	da 4,3 a 5,6	47	1
GD 144,5	4,5	da 4,6 a 5,6	47	1
GD 144,7	5	da 4,8 a 6	47	1
GD 145,5	5,5	da 5,6 a 7	47	1
GD 146,0	6	da 6,1 a 8	47	1
GD 146,5	6,5	da 6,6 a 8,2	47	1
GD 147,0	7	da 7,1 a 9	47	1
GD 147,5	7,5	da 7,6 a 9,5	47	1
GD 148,0	8	da 8,1 a 10	47	1
GD 149,0	9	da 9,1 a 11	47	1
GD 149,5	9,5	da 9,6 a 12	47	1

INSERTI 1/4"

Inserti Phillips®

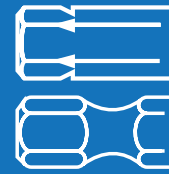

C 6,35

E 6.35

GERMANY



CONIATO DUREZZA 59 - 63 HRC - TORSION

 attacco: DIN 3126, C 6,35
 impronta: DIN 5260, PH

FEWMEC articolo		L mm	
12041	PH 1	25	10
12041 B	PH 1	25	BOX 200
12041 BX	PH 1	25	BOX 500
12041 BXL	PH 1	25	BOX 1000
12042	PH 2	25	10
12042 B	PH 2	25	BOX 200
12042 BX	PH 2	25	BOX 500
12042 BXL	PH 2	25	BOX 1000
12044	PH 3	25	10
12044 B	PH 3	25	BOX 200
12044 BX	PH 3	25	BOX 500
12044 BXL	PH 3	25	BOX 1000

MAGNETICI



INSERTI PHILLIPS MAGNETICI, CON NUOVO MAGNETE DI TESTA PER TRATTENERE LE VITI

 attacco: DIN 3126, C 6,35
 impronta: DIN 5260, PH

FEWMEC articolo		L mm	
812041	PH 1	25	10
812042	PH 2	25	10
812044	PH 3	25	10

TITANIO



CONIATO RIVESTITO TITANIO

 attacco: DIN 3126, C 6,35
 impronta: DIN 5260, PH

FEWMEC articolo		L mm	
212041 TIN	PH 1	25	10
212041 TIN B	PH 1	25	BOX 100
212042 TIN	PH 2	25	10
212042 TIN B	PH 2	25	BOX 100
212044 TIN	PH 3	25	10
212044 TIN B	PH 3	25	BOX 100

GERMANY



FRESATO DUREZZA 59 - 63 HRC

 attacco: DIN 3126, C 6,35
 impronta: DIN 5260, PH

FEWMEC articolo		L mm	
12040	PH 0	25	10
12037	PH 1	25	10
12037 B	PH 1	25	BOX 200
12038	PH 2	25	10
12038 B	PH 2	25	BOX 200
12039	PH 3	25	10
12039 B	PH 3	25	BOX 200
nota: MAGGIORATO			
12045	PH 4	32	10

GERMANY

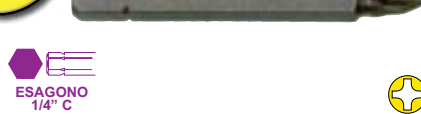

FRESATO DUREZZA 59 - 63 HRC

 attacco: DIN 3126, C 6,35
 impronta: DIN 5260, PH

FEWMEC articolo		L mm	
12046	PH 1	50	10
12047	PH 2	50	10
12050	PH 3	50	10

GERMANY



FRESATO RIVESTITO TITANIO

 attacco: DIN 3126, E 6,35
 impronta: DIN 5260, PH

FEWMEC articolo		L mm	
213021 TIN	PH 1	50	5
213022 TIN	PH 2	50	5
213023 TIN	PH 3	50	5
2135021 TIN	PH 1	70	5
2135022 TIN	PH 2	70	5
2135023 TIN	PH 3	70	5
2136021 TIN	PH 1	90	5
2136022 TIN	PH 2	90	5
2136023 TIN	PH 3	90	5

TITANIO

COLOR



INSERTI PHILLIPS COLORATI

 attacco: DIN 3126, C 6,35
 impronta: DIN 5260, PH

FEWMEC articolo		L mm	
512041	PH 1	25	10
512042	PH 2	25	10
512044	PH 3	25	10

IMPACT



INSERTO "IMPACT" RESISTE ALLE SOLLECITAZIONI DEGLI AVVITATORI AD IMPATTO

 attacco: DIN 3126, C 6,35 - E 6,35
 impronta: DIN 5260, PH

FEWMEC articolo		L mm	
2062	PH 2	25	1
2062 B	PH 2	25	BOX 100
32062	NEW PH 2	50	1

USA



TORSION - RIVESTITO TITANIO 60-63 HRC

 attacco: DIN 3126, C 6,35
 impronta: DIN 5260, PH

FEWMEC articolo	mm	L mm	
60430	PH 1	25	10
60431	PH 2	25	10
60432	PH 3	25	10

TITANIO

USA



ESAGONO 1/4" E

PRO +



FRESATO - SERIE LUNGA

attacco: DIN 3126, E 6,35
impronta: DIN 5260, PH

FEIMEC articolo		Ø mm	L mm	
27350 R	PH 1	RIBASS. Ø 3	50	5
27360	PH 1	4,5	50	5
27360 B	PH 1		50	BOX 100
27351 R	PH 2	RIBASS. Ø 4,5	50	5
27361	PH 2	6	50	5
27361 B	PH 2		50	BOX 100
27362	PH 3	6	50	5
27362 B	PH 3		50	BOX 100
40939	PH 0	3	70	5
28310	PH 1	5	75	5
28310 R	PH 1	RIBASS. Ø 3	75	5
28311	PH 2	6	75	5
28311 R	PH 2	RIBASS. Ø 4,5	75	5
28313	PH 1	5	100	5
28314 R3	PH 2	RIBASS. Ø 3	100	5
28314	PH 2	6	100	5
28314 R	PH 2	RIBASS. Ø 5	100	5

GERMANY



ESAGONO 1/4" E



FRESATO - SERIE LUNGA

attacco: DIN 3126, E 6,35
impronta: DIN 5260, PH

FEIMEC articolo		Ø mm	L mm	
13020	PH 0	3	50	5
13021	PH 1	5	50	5
13022	PH 2	6	50	5
13023	PH 3	6	50	5
13023 R	PH 3	8	50	5
13024	PH 4	10	50	5
40939	PH 0	3	70	5
135021	PH 1	5	70	5
135022	PH 2	6	70	5
135023	PH 3	6	70	5
135023 R	PH 3	8	70	5
135024	PH 4	10	70	5
135041	PH 1	5	75	5
135042	PH 2	6	75	5
135042 R	PH 2	7	75	5
135043	PH 3	6	75	5
135843 R	PH 3	8	90	5
135844 R	PH 4	10	90	5
40940	PH 0	3	100	5
135051	PH 1	5	100	5
135052	PH 2	6	100	5
135053	PH 3	6	100	5
137021	PH 1	5	110	5
137022	PH 2	6	110	5
137023	PH 3	6	110	5
137051 R	PH 1	RIBASS. Ø 4	115	5
137052 R	PH 2	RIBASS. Ø 4	115	5
137061	PH 1	5	120	5
137062	PH 2	6	120	5
137062 R	PH 2	RIBASS. Ø 4	120	5
137063	PH 3	6	120	5
138021	PH 1	5	125	5
138022	PH 2	6	125	5
138023	PH 3	6	125	5
138041	PH 1	5	127	5
138042	PH 2	6	127	5
45794	PH 1	5	150	5
45625	PH 2	6	150	5
45625 R	PH 2	RIBASS. Ø 5	150	5
27371	PH 3	6	150	5
138732 R	PH 2	Ø 7 - Ø 5	180	5
139051	PH 1	7	200	5
139052	PH 2	7	200	5
139053	PH 3	8	200	5
139054	PH 1	7	250	5
139055	PH 2	7	250	5
139058	PH 2	7	300	5

USA

ESAGONO 1/4" C



PRO +



CONIATO EXTRA HARD - DUREZZA 61 HRC

attacco: DIN 3126, C 6,35
impronta: DIN 5260, PH

FEIMEC articolo		Ø mm	L mm	
27019	PH 0	25	10	
27020	PH 1	25	10	
27020 B	PH 1	25	BOX 200	
27020 BX	PH 1	25	BOX 500	
27020 BXL	PH 1	25	BOX 1000	
27021	PH 2	25	10	
27021 B	PH 2	25	BOX 200	
27021 BX	PH 2	25	BOX 500	
27021 BXL	PH 2	25	BOX 1000	
27022	PH 3	25	10	
27022 B	PH 3	25	BOX 200	
27022 BX	PH 3	25	BOX 500	
27022 BXL	PH 3	25	BOX 1000	

JAPAN

NEW



ESAGONO 1/4" E

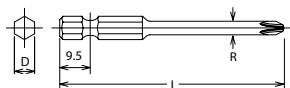

INSERTI PHILLIPS - MADE IN JAPAN

attacco: DIN 3126, E 6,35
impronta: DIN 5260, PH

Kokoen articolo		R mm	L mm	
121P-100-1	PH 1	4.5	100	10
121P-100-2	PH 2	5.5	100	10
121P-100-3	PH 3	-	100	10
121P-150-1	PH 1	4.5	150	10
121P-150-2	PH 2	5.5	150	10
121P-150-3	PH 3	-	150	10

GERMANY

RIBASSATO

ESAGONO 1/4" C



RIBASSATO - DUREZZA 61 HRC

attacco: DIN 3126, C 6,35
impronta: DIN 5260, PH

FEIMEC articolo		Ø mm	L mm	
27034 R	PH 1	RIBASS. Ø 3	25	10
27036 R	PH 2	RIBASS. Ø 4,5	25	10
27036 RK	PH 2	ECONOMICO Ø 4,5	25	10

GERMANY ANTISCIVOLO



ACR - ANTISCIVOLO - DUREZZA 61 HRC

attacco: DIN 3126, C 6,35
 impronta: DIN 5260, PH

FEWMEC articolo		L mm	
48464	PH 2	25	10

GERMANY TORSION



TORSION - DUREZZA 62 HRC

attacco: DIN 3126, C 6,35
 impronta: DIN 5260, PH

FEWMEC articolo		L mm	
50343	PH 1	25	10
50344	PH 2	25	10
50345	PH 3	25	10

GERMANY



PHILLIPS + TAGLIO

SETTORE ELETTRICO, ECC...

attacco: DIN 3126, C 6,35 - E 6,35
 impronta: PLUS MINUS

FEWMEC articolo		L mm	
41225	PH 2	25	10
41260	PH 1	70	5
43275	PH 2	70	5

GERMANY CARTONGESSO



FISSAGGIO VITI SU CARTONGESSO
 CON FERMO

attacco: DIN 3126, C 6,35 - E 6,35
 impronta: DIN 5260, PH

FEWMEC articolo		L mm	
RIGIPS	PH 2	25	10
RIGIPS B	PH 2	25	BOX 100
RIGIPS 50	PH 2	50	10



BGS articolo	DESCRIZIONE
BGS 50408	SET 10 PEZZI, INSERTI ATT. 1/4", CON BLOCCO DI PROFONDITA' PER CARTONGESSO

CARATTERISTICHE

- con blocco di profondità
- ideali per avvitare viti a filo in materiali morbidi
- evita l'avvitamento profondo su pannelli di cartongesso e pannelli da costruzione a secco
- 10 inserti, lungh. 25 mm, att. esagonale 1/4", PH 2
- peso 150 g



BGS articolo	DESCRIZIONE
BGS 50406	SET 6 PEZZI, INSERTI ATT. 1/4", CON BLOCCO DI PROFONDITA' PER CARTONGESSO



CARATTERISTICHE

- con blocco di profondità
- ideali per avvitare viti a filo in materiali morbidi
- evita l'avvitamento profondo su pannelli di cartongesso e pannelli da costruzione a secco
- comprende:
 - 3 inserti, lungh. 25 mm, att. esagonale 1/4", PH 2
 - 3 inserti, lungh. 50 mm, att. esagonale 1/4", PH 2
- peso 120 g

NOTE

Inserti Pozidriv®

 **C 6,35**
 **E 6,35**

GERMANY  

CONIATO DUREZZA 59 - 63 HRC - TORSION

attacco: DIN 3126, C 6,35
impronta: DIN 5260, PZ

articolo	+	L mm	
12060	PZ 1	25	10
12060 B	PZ 1	25	BOX 200
12060 BX	PZ 1	25	BOX 500
12060 BXL	PZ 1	25	BOX 1000
12061	PZ 2	25	10
12061 B	PZ 2	25	BOX 200
12061 BX	PZ 2	25	BOX 500
12061 BXL	PZ 2	25	BOX 1000
12062	PZ 3	25	10
12062 B	PZ 3	25	BOX 200
12062 BX	PZ 3	25	BOX 500
12062 BXL	PZ 3	25	BOX 1000

USA  

TITANIO 

MAGNATOR TORSION RIVESTITO TITANIO

attacco: DIN 3126, C 6,35
impronta: DIN 5260, PZ

PRO+ 



articolo	+	L mm	
60433	PZ 1	25	10
60434	PZ 2	25	10
60435	PZ 3	25	10

GERMANY  

FRESATO - SERIE LUNGA

attacco: DIN 3126, E 6,35
impronta: DIN 5260, PZ

articolo	+	Ø mm	L mm	
13029	PZ 0	3,5	50	5
13030	PZ 1	4,8	50	5
13031 R	PZ 2	RIBASS.Ø 4,5	50	5
13031	PZ 2	6	50	5
13032	PZ 3	6	50	5
13032 R	PZ 3	RIBASS.Ø 8	50	5
13033	PZ 4	10	50	5
134030	PZ 1	4,5	70	5
134031	PZ 2	6	70	5
134032	PZ 3	6	70	5
134032 R	PZ 3	RIBASS.Ø 8	70	5

GERMANY  

FRESATO DUREZZA 59 - 63 HRC

attacco: DIN 3126, C 6,35
impronta: DIN 5260, PZ

articolo	+	L mm	
12056	PZ 0	25	10
12057	PZ 1	25	10
12057 B	PZ 1	25	BOX 200
12058	PZ 2	25	10
12058 B	PZ 2	25	BOX 200
12059	PZ 3	25	10
12059 B	PZ 3	25	BOX 200
12063	PZ 4	32	10

GERMANY  

TITANIO 

CONIATO RIVESTITO TITANIO

attacco: DIN 3126, C 6,35
impronta: DIN 5260, PZ

articolo	+	L mm	
212060 TIN	PZ 1	25	10
212060 TIN B	PZ 1	25	BOX 100
212061 TIN	PZ 2	25	10
212061 TIN B	PZ 2	25	BOX 100
212062 TIN	PZ 3	25	10
212062 TIN B	PZ 3	25	BOX 100

GERMANY  

TITANIO 

FRESATO RIVESTITO TITANIO

attacco: DIN 3126, E 6,35
impronta: DIN 5260, PZ

articolo	+	L mm	
213030 TIN	PZ 1	50	5
213031 TIN	PZ 2	50	5
213032 TIN	PZ 3	50	5
2134030 TIN	PZ 1	70	5
2134031 TIN	PZ 2	70	5
2134032 TIN	PZ 3	70	5
2136030 TIN	PZ 1	90	5
2136031 TIN	PZ 2	90	5
2136032 TIN	PZ 3	90	5

COLOR  

INSERTI POZIDRIV COLORATI

attacco: DIN 3126, C 6,35
impronta: DIN 5260, PZ

articolo	+	L mm	
512060	PZ 1	25	10
512061	PZ 2	25	10
512062	PZ 3	25	10

135029	PZ 0	4	75	5
135030	PZ 1	4,8	75	5
135031	PZ 2	6	75	5
135032	PZ 3	6	75	5
135033	PZ 4	10	75	5
136030	PZ 1	4,8	100	5
136031	PZ 2	6	100	5
136032	PZ 3	6	100	5
137030	PZ 1	4,8	110	5
137031	PZ 2	6	110	5
137032	PZ 3	6	110	5
137032 R	PZ 3	Ø 8	110	5
137081	PZ 1	4,8	120	5
137082	PZ 2	6	120	5
137082 R	PZ 2	RIBASS.Ø 5	120	5
137083	PZ 3	6	120	5
138030	PZ 1	4,8	125	5
138031	PZ 2	6	125	5
138032	PZ 3	6	125	5
27389	PZ 1	4,8	150	5
27390	PZ 2	6	150	5
27391	PZ 3	6	150	5
27401	PZ 1	7	200	5
27402	PZ 2	7	200	5
27403	PZ 2	7	250	5

USA

**FRESATO SERIE LUNGA**
 attacco: DIN 3126, E 6,35
 impronta: DIN 5260, PZ

FEIMEC articolo	+	L mm	Ø mm	
27380	PZ 1	50	5	5
27380 B	PZ 1	50	5	BOX 100
27381	PZ 2	50	6	5
27381 B	PZ 2	50	6	BOX 100
27382	PZ 3	50	6	5
27382 B	PZ 3	50	6	BOX 100

GERMANY

**FRESATO EXTRA HARD - DUREZZA 61 HRC**
 attacco: DIN 3126, C 6,35
 impronta: DIN 5260, PZ

FEIMEC articolo	+	L mm	
47445	PZ 1	25	10
47446	PZ 2	25	10
47447	PZ 3	25	10

GERMANY

**TORSION - DUREZZA 62 HRC**
 attacco: DIN 3126, C 6,35
 impronta: DIN 5260, PZ

FEIMEC articolo	+	L mm	
50340	PZ 1	25	10
50341	PZ 2	25	10
50342	PZ 3	25	10

GERMANY

**RIBASSATO - DUREZZA 61 HRC**
 attacco: DIN 3126, C 6,35
 impronta: DIN 5260, PZ

FEIMEC articolo	+	L mm	
27060 R	PZ 1	25	10
27061 R	PZ 2	25	10

IMPACT

**INSERTO "IMPACT"**
RESISTE ALLE SOLLECITAZIONI DEGLI AVVITATORI AD IMPATTO

 attacco: DIN 3126, C 6,35
 impronta: DIN 5260, PZ

FEIMEC articolo	+	L mm	
2092	PZ 2	25	1
2092 B	PZ 2	25	BOX 100

USA



PRO +

CONIATO EXTRA HARD - DUREZZA 61 HRC
 attacco: DIN 3126, C 6,35
 impronta: DIN 5260, PZ

FEIMEC articolo	+	L mm	
27045	PZ 1	25	10
27045 B	PZ 1	25	BOX 200
27045 BX	PZ 1	25	BOX 500
27045 BXL	PZ 1	25	BOX 1000
27046	PZ 2	25	10
27046 B	PZ 2	25	BOX 200
27046 BX	PZ 2	25	BOX 500
27046 BXL	PZ 2	25	BOX 1000
27047	PZ 3	25	10
27047 B	PZ 3	25	BOX 200
27047 BX	PZ 3	25	BOX 500
27047 BXL	PZ 3	25	BOX 1000

GERMANY

**ACR - ANTISCIVOLO**
 attacco: DIN 3126, C 6,35
 impronta: DIN 5260, PZ

FEIMEC articolo	+	L mm	
35002	PZ 2	25	10

ANTISCIVOLO

GERMANY

**FRESATO DUREZZA 59 - 63 HRC**
 attacco: DIN 3126, C 6,35
 impronta: DIN 5260, PZ

FEIMEC articolo	+	L mm	
12064	PZ 1	50	5
12065	PZ 2	50	5
12066	PZ 3	50	5

MAGNETICI

INSERTI POZIDRIV MAGNETICI, CON NUOVO MAGNETE DI TESTA PER TRATTENERE LE VITI

 attacco: DIN 3126, C 6,35
 impronta: DIN 5260, PZ

FEIMEC articolo	+	L mm	
812060	PZ 1	25	10
812061	PZ 2	25	10
812062	PZ 3	25	10

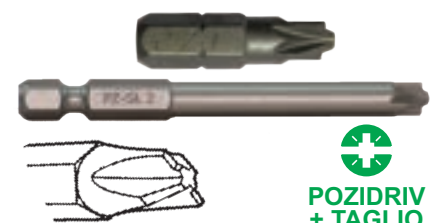

SETTORE ELETTRICO, ECC...

 attacco: DIN 3126, C 6,35 - E 6,35
 impronta: PLUS MINUS

FEIMEC articolo	+	L mm	
43225	PZ 2	25	10
43369	PZ 1	70	5
43370	PZ 2	70	5

Inserti Brugola

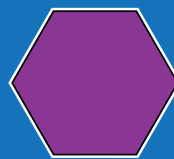

ALTA QUALITÀ

attacco: DIN 3126, C 6,35
impronta: ESAGONO

articolo	mm	L mm	
12067	1,27	25	10
12068	1,5	25	10
12069	2	25	10
12069 B	2	25	BOX 100
12070	2,5	25	10
12070 B	2,5	25	BOX 100
12071	3	25	10
12071 B	3	25	BOX 100
12072	4	25	10
12072 B	4	25	BOX 100
12073	5	25	10
12073 B	5	25	BOX 100
112073	5,5	25	10
12074	6	25	10
12074 B	6	25	BOX 100
12075	7	25	10
12076	8	25	10
12077	10	25	10



ESAGONO 1/4" E

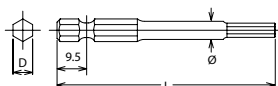

INSERTI ESAGONALI - MADE IN JAPAN

attacco: DIN 3126, E 6,35
impronta: ESAGONO

articolo	mm	Ø mm	L mm	
121H-100-2	2	3.0	100	10
121H-100-2,5	2,5	3.0	100	10
121H-100-3	3	3.5	100	10
121H-100-4	4	4.5	100	10
121H-100-5	5	5.6	100	10
121H-100-6	6	-	100	10
121H-150-2	2	3.5	150	10
121H-150-2,5	2,5	3.5	150	10
121H-150-3	3	3.5	150	10
121H-150-4	4	4.5	150	10
121H-150-5	5	5.6	150	10
121H-150-6	6	-	150	10

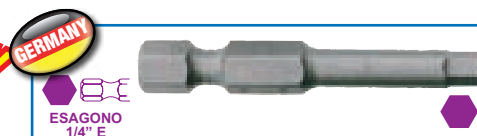

ALTA QUALITÀ

attacco: DIN 3126, E 6,35
impronta: ESAGONO

articolo	mm	Ø mm	L mm	
13038	1	3	50	5
13040	1,5	3	50	5
13041	2	3	50	5
13042	2,5	3	50	5
13043	3	4	50	5
13044	4	5	50	5
13045	5	6	50	5
13046	6	8	50	5
13047	7	8	50	5
13048	8	10	50	5
13049	10	12	50	5
113040	1,5	3	70	5
113041	2	3	70	5
113042	2,5	4	70	5
113043	3	4	70	5
113044	4	5	70	5
113045	5	6	70	5
113046	6	8	70	5
113047	7	8	75	5
113048	8	10	75	5
113049	10	12	75	5
213043	3	4	100	5
213044	4	5	100	5
213045	5	6	100	5
213046	6		100	5
213048	8		100	5
213141	2	4	115	5
213142	2,5	4	115	5
213143	3	4	115	5
213244	4	5	125	5
213245	5	6	125	5
213345	5	6	140	5
313041	2	4	150	5
313042	2,5	4	150	5
313043	3	5	150	5
313044	4	6	150	5
313045	5	6	150	5
313046	6		150	5
313048	8		150	5
413043	3	1/4"	225	5
413044	4	1/4"	225	5
413045	5	1/4"	225	5
413046	6	1/4"	225	5



SERIE ECONOMICA

attacco: DIN 3126, C 6,35
impronta: ESAGONO

articolo	mm	L mm	
BR 200	2	25	100
BR 250	2,5	25	100
BR 300	3	25	100
BR 400	4	25	100
BR 500	5	25	100
BR 600	6	25	100

INSERTI 1/4"



TESTA SFERICA ALTA QUALITÀ
attacco: DIN 3126, C 6,35
impronta: ESAGONO

articolo	mm	L mm	
110-2,5 KK	2,5	25	10
110-3 KK	3	25	10
110-4 KK	4	25	10
110-5 KK	5	25	10
110-6 KK	6	25	10
110-8 KK	8	25	10

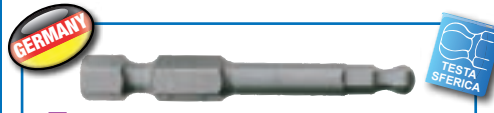

TESTA SFERICA ALTA QUALITÀ
attacco: DIN 3126, E 6,35
impronta: ESAGONO

articolo	mm	L mm	
167-2 KK	2	50	5
167-2,5 KK	2,5	50	5
167-3 KK	3	50	5
167-4 KK	4	50	5
167-5 KK	5	50	5
167-6 KK	6	50	5
167-7 KK	7	50	5
167-8 KK	8	50	5
1167-2,5 KK	2,5	70	5
1167-3 KK	3	70	5
1167-4 KK	4	70	5
1167-5 KK	5	70	5
1167-6 KK	6	70	5
1167-7 KK	7	70	5
1167-8 KK	8	70	5
1267-3 KK	3	90	5
1267-4 KK	4	90	5
1267-5 KK	5	90	5
1267-6 KK	6	90	5
1267-8 KK	8	90	5
3167-3 KK	3	150	5
3167-4 KK	4	150	5
3167-5 KK	5	150	5
3167-6 KK	6	150	5
3167-8 KK	8	150	5



MISURE IN POLLICI
attacco: DIN 3126, C 6,35
impronta: ESAGONO

articolo	pollici	L mm	
27095	1/16"	32	5
27096	5/64"	25	5
27097	3/32"	25	5
37475	7/64"	25	5
27098	1/8"	25	5
37476	9/64"	25	5
27099	5/32"	25	5
27100	3/16"	25	5
27101	7/32"	25	5
27102	1/4"	25	5
27103	5/16"	25	5



MISURE IN POLLICI
attacco: DIN 3126, E 6,35
impronta: ESAGONO

articolo	pollici	L mm	
27420	1/16"	50	5
27421	5/64"	50	5
27422	3/32"	50	5
37563	7/64"	50	5
27423	1/8"	50	5
37565	9/64"	50	5
27424	5/32"	50	5
27425	3/16"	50	5
27426	7/32"	50	5
27427	1/4"	50	5

Inserti Brugola c/foro
C 6,35
E 6,35



ESAGONO C/FORO PER VITI DI SICUREZZA

attacco: DIN 3126, C 6,35
impronta: ESAGONO CON FORO

articolo	mm	L mm	
12320	2	25	5
12325	2,5	25	5
12330	3	25	5
12340	4	25	5
12350	5	25	5
12360	6	25	5
12380	8	25	5
12390	10	25	5



ESAGONO C/FORO PER VITI DI SICUREZZA

attacco: DIN 3126, E 6,35
impronta: ESAGONO CON FORO

articolo	mm	L mm	
13641	2	50	5
13642	2,5	50	5
13643	3	50	5
13644	4	50	5
13645	5	50	5
13646	6	50	5
13648	8	50	5
13649	10	50	5
113641	2	75	5
113642	2,5	75	5
113643	3	75	5
113644	4	75	5
113645	5	75	5
113646	6	75	5
113648	8	75	5
113649	10	75	5



Inserti Torx®

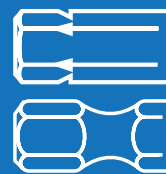

C 6,35

E 6,35



ALTA QUALITÀ - TORSION

attacco: DIN 3126, C 6,35
impronta: TORX®

FEIMEC articolo	Torx	L mm	Box
12084	TX 1	25	5
12085	TX 2	25	5
12086	TX 3	25	5
12087	TX 4	25	5
12088	TX 5	25	10
12089	TX 6	25	10
12090	TX 7	25	10
12091	TX 8	25	10
12092	TX 9	25	10
12093	TX 10	25	10
12093 B	TX 10	25	BOX 200
12093 BX	TX 10	25	BOX 500
12094	TX 15	25	10
12094 B	TX 15	25	BOX 200
12094 BX	TX 15	25	BOX 500
12095	TX 20	25	10
12095 B	TX 20	25	BOX 200
12095 BX	TX 20	25	BOX 500
12096	TX 25	25	10
12096 B	TX 25	25	BOX 200
12096 BX	TX 25	25	BOX 500
12097	TX 27	25	10
12097 B	TX 27	25	BOX 200
12097 BX	TX 27	25	BOX 500
12098	TX 30	25	10
12098 B	TX 30	25	BOX 200
12098 BX	TX 30	25	BOX 500
BGS 4735	TX 35	25	10
12099	TX 40	25	10
12099 B	TX 40	25	BOX 200
12099 BX	TX 40	25	BOX 500
12100	TX 45	25	10
12101	TX 50	25	10
12102	TX 55	25	10



SERIE ECONOMICA HRC 60 ÷

attacco: DIN 3126, C 6,35
impronta: TORX®

FEIMEC articolo	Torx	L mm	Box
TX 100	TX 10	25	100
TX 150	TX 15	25	100
TX 200	TX 20	25	100
TX 250	TX 25	25	100
TX 270	TX 27	25	100
TX 300	TX 30	25	100
TX 400	TX 40	25	100



RIVESTITO TITANIO

attacco: DIN 3126, C 6,35
impronta: TORX®

FEIMEC articolo	Torx	L mm	Box
212093 TIN	TX 10	25	10
212094 TIN	TX 15	25	10
212095 TIN	TX 20	25	10
212096 TIN	TX 25	25	10
212097 TIN	TX 27	25	10
212098 TIN	TX 30	25	10
212099 TIN	TX 40	25	10



INSERTO "IMPACT" RESISTE ALLE SOLLECITAZIONI DEGLI AVVITATORI AD IMPATTO

attacco: DIN 3126, C 6,35
impronta: TORX®

FEIMEC articolo	Torx	L mm	Box
2925	TX 25	25	1
2930	TX 30	25	1
2940	TX 40	25	1



ALTA QUALITÀ

attacco: DIN 3126, E 6,35
impronta: TORX®

FEIMEC articolo	Torx	Ø mm	L mm	Box
39925	TX 1	2	50	5
39926	TX 2	2	50	5
39927	TX 3	2	50	5
39928	TX 4	3	50	5
39929	TX 5	3,2	50	5
39930	TX 6	3,2	50	5
39931	TX 7	3,5	50	5
37713	TX 8	3,5	50	5
39933	TX 9	3	50	5
37715	TX 10	4	50	5
37717	TX 15	4	50	5
37719	TX 20	4,5	50	5
37721	TX 25	4,5	50	5
37723	TX 27	6	50	5
37725	TX 30	6	50	5
37727	TX 40	6	50	5
47745	TX 45	8	50	5
47750	TX 50	10	50	5
47755	TX 55	12	50	5
37726	TX 6	3	70	5
37728	TX 7	3	70	5
37729	TX 8	3	70	5
39937	TX 9	4	70	5
37731	TX 10	4	70	5
37733	TX 15	4	70	5
37735	TX 20	4,5	70	5
37737	TX 25	4,5	70	5
37739	TX 27	6	70	5
37741	TX 30	6	70	5
37743	TX 40	6	70	5
38746	TX 6	3	90	5
38747	TX 7	3	90	5
37745	TX 8	3	90	5
39941	TX 9	4	90	5
37747	TX 10	4	90	5
37749	TX 15	4	90	5
37751	TX 20	4,5	90	5
37753	TX 25	4,5	90	5
37755	TX 27	6	90	5
37757	TX 30	6	90	5
37759	TX 40	6	90	5
37910	TX 10	4,5	100	5
37915	TX 15	4,5	100	5
37920	TX 20	4,5	100	5
37925	TX 25	5	100	5
37927	TX 27	5,5	100	5
37930	TX 30	100	5	
37940	TX 40	100	5	

Lunghezza 150 mm
nella pagina successiva 

FEWEC					
articolo		Ø mm	L mm		
37760	TX 6	3	150	5	
37761	TX 8	3	150	5	
37762	TX 9	4	150	5	
37763	TX 10	4	150	5	
37765	TX 15	4,5	150	5	
37767	TX 20	5	150	5	
37769	TX 25	5	150	5	
37771	TX 27	6	150	5	
37773	TX 30	6	150	5	
37775	TX 40	1/4	150	5	

GERMANY

TITANIO



RIVESTITO TITANIO

 attacco: DIN 3126, E 6,35
 impronta: TORX®

FEWEC				
articolo		L mm		
239930	TIN TX 6	50	5	
237713	TIN TX 8	50	5	
237715	TIN TX 10	50	5	
237717	TIN TX 15	50	5	
237719	TIN TX 20	50	5	
237721	TIN TX 25	50	5	
237723	TIN TX 27	50	5	
237725	TIN TX 30	50	5	
237727	TIN TX 40	50	5	

JAPAN

NEW

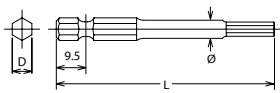

INSERTI TORX® - MADE IN JAPAN

Koken				
articolo		Ø mm	L mm	
121T-100-T10	TX 10	3.5	100	10
121T-100-T15	TX 15	3.5	100	10
121T-100-T20	TX 20	4.1	100	10
121T-100-T25	TX 25	4.6	100	10
121T-100-T27	TX 27	5.2	100	10
121T-100-T30	TX 30	5.7	100	10
121T-100-T40	TX 40	-	100	10
121T-150-T10	TX 10	3.5	150	10
121T-150-T15	TX 15	3.5	150	10
121T-150-T20	TX 20	4.1	150	10
121T-150-T25	TX 25	4.6	150	10
121T-150-T27	TX 27	5.2	150	10
121T-150-T30	TX 30	5.7	150	10
121T-150-T40	TX 40	-	150	10

GERMANY



TORX® TESTA SFERICA

 attacco: DIN 3126, C 6,35
 impronta: TORX®

FEWEC			
articolo		L mm	
12993	TK 10	25	1
12994	TK 15	25	1
12995	TK 20	25	1
12996	TK 25	25	1
12998	TK 30	25	1
12999	TK 40	25	1

GERMANY



>3°

PUNTA CONICA

 PUNTA CONICA PER UNA PRESA MIGLIORE
 IDEALE PER VITI INOX

 attacco: DIN 3126, C 6,35
 impronta: TORX®



FEWEC			
articolo		L mm	
12893	TC 10	25	10
12894	TC 15	25	10
12895	TC 20	25	10
12896	TC 25	25	10
12897	TC 27	25	10
12898	TC 30	25	10
12899	TC 40	25	10

Inserti Torx c/foro C 6,35 E 6,35



TORX® CON FORO

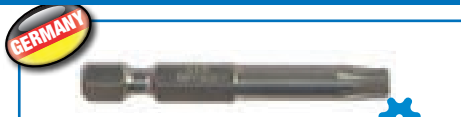

attacco: DIN 3126, C 6,35
impronta: TORX® C/FORO

articolo		L mm	
12289	TH 6	25	10
12290	TH 7	25	10
12291	TH 8	25	10
12292	TH 9	25	10
12293	TH 10	25	10
12293 B	TH 10	25	BOX 100
12294	TH 15	25	10
12294 B	TH 15	25	BOX 100
12295	TH 20	25	10
12295 B	TH 20	25	BOX 100
12296	TH 25	25	10
12296 B	TH 25	25	BOX 100
12297	TH 27	25	10
12297 B	TH 27	25	BOX 100
12298	TH 30	25	10
12298 B	TH 30	25	BOX 100
112298	TH 35	25	10
12299	TH 40	25	10
12299 B	TH 40	25	BOX 100
12300	TH 45	25	10
12301	TH 50	25	10
12302	TH 55	25	10



TORX® CON FORO

attacco: DIN 3126, E 6,35
impronta: TORX® C/FORO



articolo		L mm	
103250	TH 6	50	5
103251	TH 7	50	5
103252	TH 8	50	5
103253	TH 9	50	5
103254	TH 10	50	5
103255	TH 15	50	5
103256	TH 20	50	5
103257	TH 25	50	5
103258	TH 27	50	5
103259	TH 30	50	5
103260	TH 40	50	5
103261	TH 10	75	5
103262	TH 15	75	5
103263	TH 20	75	5
103264	TH 25	75	5
103265	TH 27	75	5
103266	TH 30	75	5
103267	TH 40	75	5
103274	TH 10	90	5
103275	TH 15	90	5
103276	TH 20	90	5
103277	TH 25	90	5
103278	TH 30	90	5
103279	TH 40	90	5
103268	TH 10	150	5
103269	TH 15	150	5
103270	TH 20	150	5
103271	TH 25	150	5
103272	TH 30	150	5
103273	TH 40	150	5



TORX® CON FORO - SERIE ECONOMICA

HRC 60 ÷

attacco: DIN 3126, C 6,35
impronta: TORX® C/FORO



articolo		L mm	
TH 100	TH 10	25	100
TH 150	TH 15	25	100
TH 200	TH 20	25	100
TH 250	TH 25	25	100
TH 270	TH 27	25	100
TH 300	TH 30	25	100
TH 400	TH 40	25	100

Inserti TORX^{plus}®



NUOVA IMPRONTA TORX® PLUS

attacco: DIN 3126, C 6,35
impronta: TORX® PLUS



articolo		L mm	
12791	TS 6	25	5
112791	TS 7	25	5
12792	TS 8	25	5
112792	TS 9	25	5
12793	TS 10	25	5
12794	TS 15	25	5
12795	TS 20	25	5
12796	TS 25	25	5
12797	TS 27	25	5
12798	TS 30	25	5
12799	TS 40	25	5



NUOVA IMPRONTA TORX® PLUS



A RICHIESTA DISPONIBILE LUNGHEZZA 90 MM

attacco: DIN 3126, E 6,35
impronta: TORX® PLUS

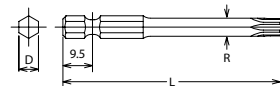
articolo		L mm	
12806	TS 6	50	5
12808	TS 8	50	5
12809	TS 9	50	5
12810	TS 10	50	5
12815	TS 15	50	5
12820	TS 20	50	5
12825	TS 25	50	5
12830	TS 30	50	5
12840	TS 40	50	5



INSERTI TORX PLUS® - MADE IN JAPAN

articolo		R mm	L mm	
121T-70-20IP	TS 20	4.1	70	10
121T-70-25IP	TS 25	4.6	70	10
121T-70-27IP	TS 27	5.2	70	10
121T-70-30IP	TS 30	5.7	70	10
121T-70-40IP	TS 40	-	70	10

Inserti pentalobati C/foro

PENTALOBATA CON FORO
5 PUNTE CON FORO

attacco: DIN 3126, C 6,35

impronta: 5 PUNTE C/FORO

FEIMEC articolo	Icona	L mm	Box
TP 8	T 8	25	10
TP 10	T 10	25	10
TP 15	T 15	25	10
TP 20	T 20	25	10
TP 25	T 25	25	10
TP 27	T 27	25	10
TP 30	T 30	25	10
TP 40	T 40	25	10
TP 45	T 45	25	10
TP 50	T 50	25	10

PENTALOBATA CON FORO
BOX N°10 INSERTI + PORTA INSERTI MAGNETICO

attacco: DIN 3126, C 6,35

impronta: 5 PUNTE C/FORO

FEIMEC articolo	Icona	Descrizione	Box
TP 1040	T 8/40	BOX 11 PEZZI	1

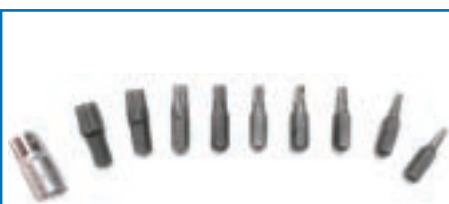
PENTALOBATA CON FORO
BOX N°9 INSERTI + BUSSOLA 1/4" PORTA INSERTI IN BOX IN PLASTICA

attacco: DIN 3126, C 6,35

impronta: 5 PUNTE C/FORO

FEIMEC articolo	Icona	Descrizione	Box
TP 5010	T 10/50	BOX INSERTI 10 PEZZI	1

PENTALOBATA CON FORO

PRO +



BGS 4993

DESCRIZIONE

SET 23 PEZZI, INSERTI TORX PLUS E 5 PUNTE CON FORO

CARATTERISTICHE

- adatto per viti Torx PLUS
- comprende:
 - porta inserti attacco 1/4"
 - adattatore porta inserti attacco 1/4"
 - adattatore porta inserti attacco 1/2"
- inserti 5 punte pentalobati con foro (TPH): TP 10H, 15 H, 20H, 25H, 30H, 40H, 45H, 50H, 55H, 60H
- inserti 6 punte Torx plus senza foro (TPS): TPS 10, 15, 20, 25, 30, 40, 45, 50, 55, 60
- peso 420 g

PENTALOBATA CON FORO
CACCIAVITI 5 PUNTE C/FORO PER VITI PENTALOBATE

FEIMEC articolo	Icona	L mm	Box
IPR-10	TP 10	125	1
IPR-15	TP 15	125	1
IPR-20	TP 20	125	1
IPR-25	TP 25	125	1
IPR-27	TP 27	125	1
IPR-30	TP 30	125	1
IPR-40	TP 40	125	1
IPR-45	TP 45	125	1

PENTALOBATA CON FORO

PRO +



BGS 2355

DESCRIZIONE

SET 9 PEZZI, CHIAVI A BUSSOLA 5 PUNTE C/FORO

CARATTERISTICHE

- TS-10-15-20-25-27-30-40-45-50
- per viti antifurto in fissaggio di pompe di MB Atego, Actros e Rover
- su guida porta bussola, imballaggio supplementare in custodia di plastica
- peso 250 g

Inserti SIT ASSY

C 6,35



SIT® ASSY 1/4

PER VITI ASSY® TIPO WÜRTH

attacco: DIN 3126, C 6,35

impronta: SIT®

FEIMEC articolo	Icona	L mm	Box
SIT-10	10	25	5
SIT-15	15	25	5
SIT-20	20	25	5
SIT-25	25	25	5
SIT-30	30	25	5
SIT-40	40	25	5

Inserti Spanner®

SETTORE TELEFONIA

attacco: DIN 3126, C 6,35

impronta: SPANNER®

FEIMEC articolo	Icona	"A" mm	L mm	Box
35421	SP 4	3,8	25	5
35422	SP 6	4,5	25	5
35423	SP 8	5	25	5
35424	SP 10	6	25	5
45425	SP 12	7	25	5
45426	SP 14	8	25	5

DISPONIBILI LUNGHEZZA 75 MM NEI KIT ARTICOLI BGS 762 E BGS 757
Inserti RIBE®

SETTORE AUTO

attacco: DIN 3126, C 6,35

impronta: RIBE®

FEIMEC articolo	Icona	L mm	Box
112- 5	M 5	25	5
112- 6	M 6	25	5
112- 8	M 8	25	5
112- 10	M 10	25	5



Inserti Tri-Wing



SETTORE AERONAUTICA A NORME NASA

attacco: DIN 3126, C 6,35
impronta: TRI-WING

articolo	ESAGONO 1/4" C	L mm	ESAGONO 1/4" C
35409	TW 0	25	5
35410	TW 1	25	5
35411	TW 2	25	5
35412	TW 3	25	5
35413	TW 4	25	5
35414	TW 5	25	5
35415	TW 6	28	5

Inserti Torq-set



SETTORE AERONAUTICA A NORME NASA

attacco: DIN 3126, C 6,35 - 5/16"
impronta: TORQ-SET

articolo	ESAGONO 1/4" - 5/16" C	L mm	ESAGONO 1/4" - 5/16" C
35395	TS 0	25	5
35396	TS 1	25	5
35397	TS 2	25	5
35398	TS 3	25	5
35399	TS 4	25	5
35400	TS 5	25	5
35401	TS 6	25	5
35402	TS 8	25	5
35403	TS 10	25	5
37404	TS 1/4"	25	5
37408	TS 5/16"	25	5
attacco: 5/16" DIN 3126, C 8			
35404	TS 8	32	5
35405	TS 10	32	5
35406	TS 1/4"	32	5
35407	TS 5/16"	32	5
35408	TS 3/8"	32	5



SETTORE AERONAUTICA A NORME NASA

attacco: 7/16"
impronta: TORQ-SET

articolo	ESAGONO 7/16"	L mm	ESAGONO 7/16"
222402	TS 1/4"	35	5
222403	TS 5/16"	35	5
224649	TS 3/8"	35	5
222405	TS 7/16"	35	5

Inserti quadro



QUADRO MASCHIO

attacco: DIN 3126, C 6,35
impronta: QUADRO

articolo	ESAGONO 1/4" C	L mm	"A" mm	ESAGONO 1/4" C
38509	R 0	25	1,8	5
29049	R 1	25	2,3	5
29050	R 2	25	2,9	5
29051	R 3	25	3,5	5



QUADRO MASCHIO

attacco: DIN 3126, E 6,35
impronta: QUADRO

articolo	ESAGONO 1/4" E	L mm	ESAGONO 1/4" E
129051	R 0	50	5
29052	R 1	50	5
29053	R 2	50	5
29054	R 3	50	5
29151	R 1	75	5
29152	R 2	75	5
29153	R 3	75	5
29253	R 2	100	5

Inserti Triangolari



attacco: DIN 3126, E 6,35
impronta: TRIANGOLARE

articolo	ESAGONO 1/4" E	L mm	ESAGONO 1/4" E
TA-1350	1,3	50	1
TA-1850	1,8	50	1
TA-2050	2	50	1
TA-2350	2,3	50	1
TA-2850	2,8	50	1
TA-3050	3,0	50	1

Inserti XZN® Poligonale



POLIGONALE XZN®

attacco: DIN 3126, C 6,35
impronta: XZN®

articolo	ESAGONO 1/4" C	L mm	ESAGONO 1/4" C
111-4	M 4	25	5
111-5	M 5	25	5
111-6	M 6	25	5
111-8	M 8	25	5



INSERTI XZN - MADE IN JAPAN

articolo	ESAGONO 5/16" C	L mm	ESAGONO 5/16" C
100X-32-M5	M 5	32	5
100X-32-M6	M 6	32	5
100X-32-M8	M 8	32	5
100X-32-M10	M 10	32	5
100X-32-M12	M 12	32	5



POLIGONALE XZN®

attacco: DIN 3126, E 6,35
impronta: XZN®

articolo	ESAGONO 1/4" E	L mm	ESAGONO 1/4" E
2111-4	M 4	75	5
2111-5	M 5	75	5
2111-6	M 6	75	5
2111-8	M 8	75	5

Inserti a doppia punta

INSERTI 1/4" DOPPIA PUNTA

TAGLIO / PHILLIPS®
attacco: DIN 3126, C 6,35

FEARTEC articolo	Logo	L mm	Box
112081	0,8 x 4 mm + PH1	60	5
112083	1,0 x 6 mm + PH2	60	5

PHILLIPS® / PHILLIPS®
attacco: DIN 3126, C 6,35

FEARTEC articolo	Logo	L mm	Box
112451	PH1 + PH1	45	5
112452	PH2 + PH2	45	5
114601	PH1 + PH1	75	5
114602	PH2 + PH2	75	5

TAGLIO / POZIDRIV®
attacco: DIN 3126, C 6,35

FEARTEC articolo	Logo	L mm	Box
112085	0,8x4 mm + PZ1	60	5
112086	1,0x5,5 mm + PZ2	60	5

POZIDRIV® / POZIDRIV®
attacco: DIN 3126, E 6,35

FEARTEC articolo	Logo	L mm	Box
112495	PZ1 + PZ1	50	5
112496	PZ2 + PZ2	50	5

BGS 7988-1

CV

BGS 7988

DESCRIZIONE
SET 11 PEZZI, CACCIAVITI

CARATTERISTICHE

- satinati cromati
- con lame intercambiabili
- lunghezza lame: 175 mm
- 20 in 1
- impugnatura con due attacchi 1/4", con rivestimento in gomma antiscivolo
- Taglio: 4+6 mm, 5+7 mm,
- PH: 1+2
- PZ: 1+2
- Esagono: 4 mm + 4 mm testa sferica
5 mm + 5 mm testa sferica
6 mm + 6 mm testa sferica
- Torx: TX10+TX15, TX20+TX25, TX30+TX40
- peso 810 g

RICAMBI

BGS articolo	DESCRIZIONE
BGS 7988-1	IMPUGNATURA CON 2 ATTACCHI 1/4"

PHILLIPS® / PHILLIPS®
LAME REVERSIBILI COMBI PHILLIPS® L. 175 MM
attacco: DIN 3126, C 6,35

FEARTEC articolo	Logo	L mm	Box
2162-0102	PH1 PH2	175	1

POZIDRIV® / POZIDRIV®
LAME REVERSIBILI COMBI POZIDRIV® L. 175 MM
attacco: DIN 3126, C 6,35

FEARTEC articolo	Logo	L mm	Box
2164-0102	PZ1 PZ2	175	1

TORX® / TORX®
LAME REVERSIBILI COMBI TORX®
attacco: DIN 3126, C 6,35

FEARTEC articolo	Logo	L mm	Box
2168-0506	T5 T6	175	1
2168-0708	T7 T8	175	1
2168-0910	T9 T10	175	1
2168-1520	T15 T20	175	1
2168-2527	T25 T27	175	1
2168-3040	T30 T40	175	1

TAGLIO / TAGLIO
LAME REVERSIBILI COMBI TAGLIO L. 175 MM
attacco: DIN 3126, C 6,35



FEARTEC articolo	Logo	L mm	Box
2160-4060	4,0x0,5 6,0x1,0	175	1
2160-6570	6,5x1,2 7,0x1,2	175	1

ESAGONO / ESAGONO
LAME REVERSIBILI COMBI ESAGONO L. 175 MM
attacco: DIN 3126, C 6,35

FEARTEC articolo	Logo	L mm	Box
2166-0003	3mm 3mm	175	1
2166-0004	4mm 4mm	175	1
2166-0005	5mm 5mm	175	1
2166-0006	6mm 6mm	175	1



Inserti 5/16"

Inserti Taglio 5/16"

   **TAGLIO**

ALTA QUALITÀ POWER IMPACT
attacco: DIN 3126, C 8
impronta: 5264-C

articolo	mm	L mm	
112514	0,8 x 5,5	41	5
12515	1 x 6	41	5
12516	1,2 x 6,5	41	5
112517	1,2 x 8	41	5
12518	1,6 x 8	41	5
112519	1,6 x 10	41	5
112520	2 x 12	41	5
112521	2,5 x 14	41	5

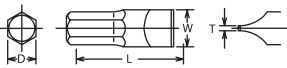

   **TAGLIO**

INSERTI TAGLIO - MADE IN JAPAN
attacco: DIN 3126, C 8
impronta: 5264-C



Koken articolo	T x W mm	L mm	
100S-32-6	1 X 6	32	5
100S-32-7	1 X 7	32	5
100S-32-8	1,2 X 8	32	5
100S-32-9	1,6 X 9	32	5
100S-32-10	1,6 X 10	32	5
100S-32-11	1,6 X 11	32	5
100S-32-12	2 X 12	32	5
100S-32-14	2 X 14	32	5
100S-80-6	1 X 6	80	5
100S-80-7	1 X 7	80	5
100S-80-8	1,2 X 8	80	5
100S-80-9	1,6 X 9	80	5
100S-80-10	1,6 X 10	80	5
100S-80-11	1,6 X 11	80	5
100S-80-12	2 X 12	80	5
100S-80-14	2 X 14	80	5

Inserti Phillips® 5/16"

   **PHILLIPS®**

ALTA QUALITÀ POWER IMPACT
attacco: DIN 3126, C 8
impronta: DIN 5260, PH

articolo		L mm	
12541	PH 1	32	5
12542	PH 2	32	5
12544	PH 3	32	5
12545	PH 4	32	5

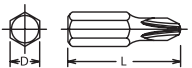

   **PHILLIPS®**

INSERTI PHILLIPS - MADE IN JAPAN
attacco: DIN 3126, C 8
impronta: DIN 5260, PH



Koken articolo		L mm	
100P-32-PH1	PH 1	32	5
100P-32-PH2	PH 2	32	5
100P-32-PH3	PH 3	32	5
100P-32-PH4	PH 4	32	5
100P-80-PH1	PH 1	80	5
100P-80-PH2	PH 2	80	5
100P-80-PH3	PH 3	80	5
100P-80-PH4	PH 4	80	5
100P-125-PH2	PH 2	125	5
100P-125-PH3	PH 3	125	5

Inserti Pozidriv® 5/16"

   **POZIDRIV®**

ALTA QUALITÀ POWER IMPACT
attacco: DIN 3126, C 8
impronta: DIN 5260, PZ

articolo		L mm	
12560	PZ 1	41	5
12561	PZ 2	32	5
12562	PZ 3	32	5
12563	PZ 4	32	5

   **POZIDRIV®**

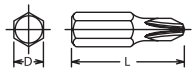
INSERTI POZIDRIV - MADE IN JAPAN
attacco: DIN 3126, C 8
impronta: DIN 5260, PZ

Koken articolo		L mm	
100P-32-PZ2	PZ 2	32	5
100P-32-PZ3	PZ 3	32	5

     **PRO+** 

BGS articolo **DESCRIZIONE**

BGS 711 **SET 4 PEZZI, INSERTI ATTACCO 5/16"**

CARATTERISTICHE

- attacco esagonale da 5/16 mm
- lunghezza 36 mm
- 2 inserti Taglio: 8 - 10 mm
- 2 inserti PH: 2 - 3
- peso 60 g

INSERTI 5/16"



Inserti Brugola



ALTA QUALITÀ POWER IMPACT

attacco: DIN 3126, C 8
impronta: ESAGONO

FEIMEC articolo	mm	L mm	
12571	3	30	5
12572	4	30	5
12573	5	30	5
12574	6	30	5
12575	7	30	5
12576	8	30	5
12577	10	30	5
12578	12	30	5
12579	14	30	5

Inserti Torx®



ALTA QUALITÀ POWER IMPACT

attacco: DIN 3126, C 8
impronta: TORX®

FEIMEC articolo	mm	L mm	
12594	TX 15	35	5
12595	TX 20	35	5
12596	TX 25	35	5
12597	TX 27	35	5
12598	TX 30	35	5
12599	TX 40	35	5
12600	TX 45	35	5
12601	TX 50	35	5
12602	TX 55	35	5
12603	TX 60	35	5
12604	TX 70	35	5

Inserti Torx c/foro



ALTA QUALITÀ POWER IMPACT

attacco: DIN 3126, C 8
impronta: TORX® C/FORO

FEIMEC articolo	mm	L mm	
12593-F	TH 10	35	5
12594-F	TH 15	35	5
12595-F	TH 20	35	5
12596-F	TH 25	35	5
12597-F	TH 27	35	5
12598-F	TH 30	35	5
12599-F	TH 40	35	5
12600-F	TH 45	35	5
12601-F	TH 50	35	5
12602-F	TH 55	35	5
12603-F	TH 60	35	5
12604-F	TH 70	35	5



INSERTI ESAGONO - MADE IN JAPAN

attacco: DIN 3126, C 8
impronta: ESAGONO

Koken articolo	mm	L mm	
100H-32-3	3	32	5
100H-32-4	4	32	5
100H-32-5	5	32	5
100H-32-6	6	32	5
100H-32-7	7	32	5
100H-32-8	8	32	5
100H-32-9	9	32	5
100H-32-10	10	32	5
100H-32-11	11	32	5
100H-32-12	12	32	5
100H-32-14	14	32	5



INSERTI TORX - MADE IN JAPAN

attacco: DIN 3126, C 8
impronta: TORX®

Koken articolo	TX	L mm	
100T-32-T10	T10	32	5
100T-32-T15	T15	32	5
100T-32-T20	T20	32	5
100T-32-T25	T25	32	5
100T-32-T27	T27	32	5
100T-32-T30	T30	32	5
100T-32-T40	T40	32	5
100T-32-T45	T45	32	5
100T-32-T50	T50	32	5
100T-32-T55	T55	32	5

Inserti XZN



ALTA QUALITÀ POWER IMPACT

attacco: DIN 3126, C 8
impronta: XZN®

FEIMEC articolo	mm	L mm	
126 - 5	M 5	28	5
126 - 6	M 6	28	5
126 - 8	M 8	28	5
126 - 10	M 10	32	5
126 - 12	M 12	38	5
126 - 14	M 14	38	5

Inserti RIBE®



ALTA QUALITÀ POWER IMPACT

attacco: DIN 3126, C 8
impronta: RIBE®

FEIMEC articolo	mm	L mm	
127 - 5	M 5	35	5
127 - 6	M 6	35	5
127 - 7	M 7	35	5
127 - 8	M 8	35	5
127 - 10	M 10	35	5
127 - 12	M 12	35	5
127 - 14	M 14	42	5
127 - 16	M 16	45	5

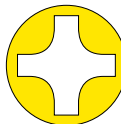

Inserti

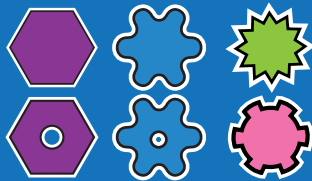

10-14 mm.

Inserti Phillips



10 mm



PH

attacco: 10 mm
impronta: DIN 5260, PH

articolo	mm	L mm	5
BGS 4601	PH 2	30	5
BGS 4602	PH 3	30	5

Inserti Brugola



10 mm



BRUGOLA TCCE

attacco: 10 mm
impronta: ESAGONO

articolo	mm	L mm	5
271-0430	4	30	5
271-0530	5	30	5
271-0630	6	30	5
271-0730	7	30	5
271-0830	8	30	5
271-1030	10	30	5
271-1230	12	30	5
271-1430	14	30	5

Inserti Brugola c/foro



10 mm



BRUGOLA TCCE C/FORO

attacco: 10 mm
impronta: ESAGONO C/FORO

articolo	mm	L mm	5
2721-0430	4	30	5
2721-0530	5	30	5
2721-0630	6	30	5
2721-0730	7	30	5
2721-0830	8	30	5
2721-1030	10	30	5
2721-1230	12	30	5

Inserti Taglio



10 mm



TAGLIO

attacco: 10 mm
impronta: TAGLIO

articolo	mm	L mm	5
BGS 4599	8	30	5
BGS 4600	10	30	5



BRUGOLA TCCE

attacco: 10 mm
impronta: ESAGONO

articolo	mm	L mm	5
272-0475	4	75	5
272-0575	5	75	5
272-0675	6	75	5
272-0775	7	75	5
272-0875	8	75	5
272-1075	10	75	5
272-1275	12	75	5
272-1475	14	75	5



BRUGOLA TCCE C/FORO

attacco: 10 mm
impronta: ESAGONO C/FORO

articolo	mm	L mm	5
2723-0475	4	75	5
2723-0575	5	75	5
2723-0675	6	75	5
2723-0775	7	75	5
2723-0875	8	75	5
2723-1075	10	75	5
2723-1275	12	75	5

**Inserti
Torx®**

 10
mm

TORX®

 attacco: 10 mm - 14 mm
 impronta: TORX®

FEEMEC articolo		L mm	
275-1030	TX 10	30	5
275-1530	TX 15	30	5
275-2030	TX 20	30	5
275-2530	TX 25	30	5
275-2730	TX 27	30	5
275-3030	TX 30	30	5
275-4030	TX 40	30	5
275-4530	TX 45	30	5
275-5030	TX 50	30	5
275-5530	TX 55	30	5
275-6030	TX 60	30	5
275-6050	TX 60	50 ATT.14 MM	5
275-7050	TX 70	50 ATT.14 MM	5

TORX®

 attacco: 10 mm - 14 mm
 impronta: TORX®

FEEMEC articolo		L mm	
276-1075	TX 10	75	5
276-1575	TX 15	75	5
276-2075	TX 20	75	5
276-2575	TX 25	75	5
276-2775	TX 27	75	5
276-3075	TX 30	75	5
276-4075	TX 40	75	5
276-4575	TX 45	75	5
276-5075	TX 50	75	5
276-5575	TX 55	75	5
BGS 4598	TX 60	75	5
276-6078	TX 60	78 ATT.14 MM	5
276-7078	TX 70	78 ATT.14 MM	5

**Inserti
Torx c/foro**

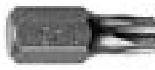
 10
mm

TORX® C/FORO

 attacco: 10 mm
 impronta: TORX® C/FORO

FEEMEC articolo		L mm	
278-1030	TH 10	30	5
278-1530	TH 15	30	5
278-2030	TH 20	30	5
278-2530	TH 25	30	5
278-2730	TH 27	30	5
278-3030	TH 30	30	5
278-4030	TH 40	30	5
278-4530	TH 45	30	5
278-5030	TH 50	30	5
278-5530	TH 55	30	5

TORX® C/FORO

 attacco: 10 mm - 14 mm
 impronta: TORX® C/FORO

FEEMEC articolo		L mm	
279-1075	TH 10	75	5
279-1575	TH 15	75	5
279-2075	TH 20	75	5
279-2575	TH 25	75	5
279-2775	TH 27	75	5
279-3075	TH 30	75	5
279-4075	TH 40	75	5
279-4575	TH 45	75	5
279-5075	TH 50	75	5
279-5575	TH 55	75 ATT.14 MM	5

**Inserti
XZN**

 10
mm

XZN®

 attacco: 10 mm
 impronta: XZN®

FEEMEC articolo		L mm	
273-0530	M 5	30	5
273-0630	M 6	30	5
273-0830	M 8	30	5
273-1030	M 10	30	5
273-1230	M 12	30	5
273-1430	M 14	30	5

XZN®



 attacco: 10 mm
 impronta: XZN®

FEEMEC articolo		L mm	
274-0575	M 5	75	5
274-0675	M 6	75	5
274-0875	M 8	75	5
274-1075	M 10	75	5
274-1275	M 12	75	5
274-1475	M 14	75	5

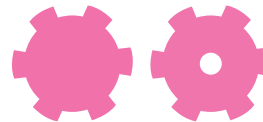





Inserti RIBE®  

 

RIBE®
attacco: 10 mm
impronta: RIBE®



FEIMEC articolo	M	L mm	
284-0430	M 4	30	5
284-0530	M 5	30	5
284-0630	M 6	30	5
284-0730	M 7	30	5
284-0830	M 8	30	5
284-0930	M 9	30	5
284-1030	M 10	30	5
284-1130	M 11	30	5
284-1230	M 12	30	5
284-1330	M 13	30	5
284-1430	M 14	30	5
284-1630	M 16	30	5

RIBE®
attacco: 10 mm
impronta: RIBE®



FEIMEC articolo	M	L mm	
286-0475	M 4	75	5
286-0575	M 5	75	5
286-0675	M 6	75	5
286-0775	M 7	75	5
286-0875	M 8	75	5
286-0975	M 9	75	5
286-1075	M 10	75	5
286-1275	M 12	75	5
286-1375	M 13	75	5
286-1475	M 14	75	5
286-1675	M 16	75	5
296-5100	M 5	100	5
296-6100	M 6	100	5
296-7100	M 7	100	5
296-8100	M 8	100	5
296-9100	M 9	100	5
296-1000	M 10	100	5
296-1003	M 10,3	100	5
296-1100	M 11	100	5
296-1200	M 12	100	5
296-1300	M 13	100	5
296-1400	M 14	100	5

Inserti RIBE®  

 

RIBE® C/FORO
attacco: 10 mm
impronta: RIBE® C/FORO

FEIMEC articolo	M	L mm	
285-0430	M 4	30	5
285-0530	M 5	30	5
285-0630	M 6	30	5
285-0730	M 7	30	5
285-0830	M 8	30	5
285-0930	M 9	30	5
285-1030	M 10	30	5
285-1230	M 12	30	5
285-1330	M 13	30	5

RIBE® C/FORO
attacco: 10 mm - 14 mm
impronta: RIBE® C/FORO

FEIMEC articolo	M	L mm	
287-0475	M 4	75	5
287-0575	M 5	75	5
287-0675	M 6	75	5
287-0775	M 7	75	5
287-0875	M 8	75	5
287-0975	M 9	75	5
287-1075	M 10	75	5
287-1275	M 12	75	5
287-1375	M 13	75	5
287-1475	M 14	75 ATT.14 MM	5
287-1675	M 16	75 ATT.17 MM	5
399-5100	M 5	100	5
399-6100	M 6	100	5
399-7100	M 7	100	5
399-8100	M 8	100	5
399-9100	M 9	100	5
399-1000	M 10	100	5
399-1200	M 12	100	5
399-1300	M 13	100	5
399-1400	M 14	100	5



BUSSOLA PORTA INSERTI CROMATA CON SFERA DI TENUTA

attacco: Quadro femmina

FEIMEC articolo	ESAGONO	L mm	
280-0038	3/8"	10 mm	1
280-0012	1/2"	10 mm	1
281-0012	1/2"	14 mm	1



BGS articolo

BGS 353

DESCRIZIONE

CRICCHETTO PORTAINSERI ATTACCO ESAGONALE 10 MM, LUNGHEZZA 135 MM

- CARATTERISTICHE**
- per l'inserimento di inserti senza necessità di adattatore
 - lunghezza: 135 mm



- BGS** articolo
- BGS 6656**
- DESCRIZIONE**
- CRICCHETTO REVERSIBILE PORTAINSERI, ATT. ESAGONALE 10 MM**
- CARATTERISTICHE**
- cricchetto reversibile 72 denti
 - impugnatura ergonomica anticivolo in materiale bi-componente
 - attacco esagono femmina 10 mm
 - lunghezza 240 mm
 - peso: 370 g

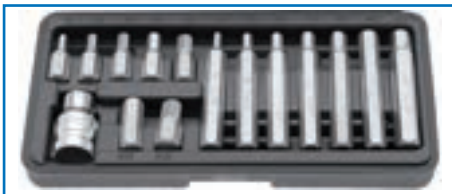

BGS articolo	DESCRIZIONE
BGS 5070	SET 15 PEZZI, INSERTI ESAGONALI

- CARATTERISTICHE**
- inserti Esagonali, lunghezza 30 mm: 4-5-6-7-8-10-12 mm
 - inserti Esagonali, lunghezza 75 mm: 4-5-6-7-8-10-12 mm
 - 1 adattatore portainseriti 10 mm, attacco quadro femmina da 1/2"
 - peso 710 g



- **ESAGONO MM 4-5-6-7-8-10-12 LUNGHEZZA 30 MM**
- **ESAGONO MM 4-5-6-7-8-10-12 LUNGHEZZA 75 MM**
- **N. 1 BUSSOLA PORTAINSERITI 1/2"**

attacco: 10 mm
impronta: ESAGONO C/FORO

	Descrizione	
articolo	CASSETTA METALLICA	1
2725	15 PEZZI	



BGS articolo	DESCRIZIONE
BGS 5040	SET 15 PEZZI, INSERTI TORX

- CARATTERISTICHE**
- inserti TORX lungh. 30 mm: TX 20-25-30-40-45-50-55
 - inserti TORX lungh. 75 mm: TX 20-25-30-40-45-50-55
 - 1 adattatore portainseriti 10 mm, attacco quadro femmina da 1/2"
 - peso 650 g



BGS articolo	DESCRIZIONE
BGS 5017	SET 7 PEZZI, INSERTI 10 MM ESAGONALI CON ADATTATORE

- CARATTERISTICHE**
- 6 inserti esagonali attacco 10 mm: 4-5-6-8-10-12 mm
 - lunghezza 30 mm
 - 1 adattatore portainseriti 10 mm, attacco quadro femmina da 1/2"
 - peso 160 g



- **TX. 10-15-20-25-27-30-40-45-50-55 LUNGHEZZA 30 MM**
- **TX. 10-15-20-25-27-30-40-45-50-55 LUNGHEZZA 75 MM**
- **N. 2 BUSSOLE PORTAINSERITI 3/8"-1/2"**

attacco: 10 mm
impronta: TX

	Descrizione	
articolo	CASSETTA METALLICA	1
5714	22 PEZZI	

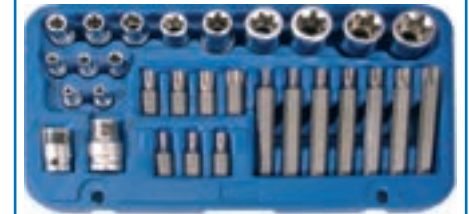

BGS articolo	DESCRIZIONE
BGS 5025	SET 30 PEZZI, BUSSOLE E INSERTI TORX

- CARATTERISTICHE**
- bussole Torx femmina attacco quadro femmina:
 - 1/4": E4 - E5 - E6 - E7 - E8
 - 3/8": E10 - E11 - E12 - E14
 - 1/2": E16 - E18 - E20 - E22 - E24
 - inserti Torx lunghezza 30 mm: TX20 - TX25 - TX30 - TX40 - TX45 - TX50 - TX55
 - inserti Torx lunghezza 75 mm: TX20 - TX25 - TX30 - TX40 - TX45 - TX50 - TX55
 - adattatori portainseriti 10 mm:
 - att. quadro femmina 1/2"
 - att. quadro femmina 3/8"
 - finitura satinata cromata
 - peso 1,4 kg

RICAMBI

BGS articolo	DESCRIZIONE
BGS 5025-LEER	CASSETTA VUOTA



TORX
CON FORO

ESAGONO
10 mm

TORX

PRO+ **CV**

BGS articolo	DESCRIZIONE	
BGS 5016	SET 7 PEZZI, INSERTI 10 MM TORX CON ADATTATORE	

CARATTERISTICHE

- 6 inserti TORX attacco 10 mm, lunghezza 30 mm: TX25, TX30, TX40, TX45, TX50, TX55
- 1 adattatore portainseriti 10 mm, attacco quadro femmina da 1/2"
- peso 180 g



TORX
CON FORO

ESAGONO
10 mm

- **TORX C/FORO**
- TH. 10-15-20-25-27-30-40-45-50-55 LUNGHEZZA 30 MM
- TH. 10-15-20-25-27-30-40-45-50-55 LUNGHEZZA 75 MM
- N. 2 BUSSOLE PORTAINSERI 3/8"-1/2"

attacco: 10 mm
impronta: TORX C/FORO

BGS articolo	Descrizione	
2715	CASSETTA METALLICA 22 PEZZI	1



RIBE

ESAGONO
10 mm

- **RIBE® M 5-6-7-8-9-10-11-12-13 LUNGHEZZA 30 MM**
- **RIBE® M 5-6-7-8-9-10-11-12-13-14 LUNGHEZZA 75 MM**
- N. 2 BUSSOLE PORTAINSERI 3/8"-1/2"

attacco: 10 mm
impronta: RIBE®

BGS articolo	Descrizione	
5735	CASSETTA METALLICA 21 PEZZI	1



TORX
CON FORO

PRO+ **CV**

ESAGONO
10 mm

BGS articolo	DESCRIZIONE	
BGS 5022	SET 22 PEZZI, INSERTI TORX CON FORO	

CARATTERISTICHE

- inserti attacco esagonale 10 mm
- inserti Torx c/foro lunghezza 30 mm e 75 mm: TH 10-15-20-25-27-30-40-45-50-55-60-70
- adattatore portainseriti 10 mm:
 - att. quadro femmina 1/2"
 - att. quadro femmina 3/8"



ESAGONO
10 mm

XZN

PRO+ **CV**

BGS articolo	DESCRIZIONE	
BGS 5006	SET 6 PEZZI, INSERTI 10 MM XZN CON ADATTATORE	

CARATTERISTICHE

- 5 inserti XZN attacco 10 mm, lunghezza 30 mm: M5, M6, M8, M10, M12
- 1 adattatore portainseriti 10 mm, attacco quadro femmina da 1/2"
- peso 160 g



XZN

BGS

CV

ESAGONO
10 mm

BGS articolo	DESCRIZIONE	
BGS 5030	SET 11 PEZZI, INSERTI XZN	

CARATTERISTICHE

- 5 inserti XZN lungh. 30 mm: M5-M6-M8-M10-M12
- 5 inserti XZN lungh. 75 mm: M5-M6-M8-M10-M12
- 1 adattatore portainseriti 10 mm, attacco quadro femmina da 1/2"
- peso 580 g



RIBE

PRO+ **CV**

ESAGONO
10 mm

BGS articolo	DESCRIZIONE	
BGS 5013	SET 22 PEZZI, INSERTI RIBE, LUNGHEZZA 30 E 100 MM	

CARATTERISTICHE

- inserti Ribe attacco 10 mm
- inserti Ribe lunghezza 30 mm: M5-M6-M7-M8-M9-M10-M11-M12-M13
- inserti Ribe **lunghezza 100 mm**: M5-M6-M7-M8-M9-M10-M10,3-M11-M12-M13-M14
- 2 adattatori 3/8" + 1/2" per inserti da 10 mm
- peso 1,6 kg

RICAMBI

BGS articolo	DESCRIZIONE	
BGS 5013-LEER	CASSETTA VUOTA	



- RIBE® C/FORO M 4-5-6-7-8-9-10-12-13 LUNGHEZZA 30 MM
- RIBE® C/FORO M 4-5-6-7-8-9-10-12-13 LUNGHEZZA 75 MM
- N. 2 BUSSOLE PORTA INSERTI 3/8"-1/2"

attacco: 10 mm

impronta: RIBE® C/FORO

	Descrizione	
articolo 2736	CASSETTA METALLICA 20 PEZZI	1



- ESAGONO MM 4-5-6-7-8-10-12 LUNGHEZZA 30 MM
- ESAGONO MM 4-5-6-7-8-10-12 LUNGHEZZA 75 MM
- TORX® TX 20-25-30-40-45-50-55 LUNGHEZZA 30 MM
- TORX® TX 20-25-30-40-45-50-55 LUNGHEZZA 75 MM
- TORX® TX 60-70 LUNGHEZZA 50 MM ATTACCO 14 MM
- TORX® TX 60-70 LUNGHEZZA 78 MM ATTACCO 14 MM
- N. 2 BUSSOLE PORTAININSERTI 3/8"-1/2"
- N. 1 BUSSOLA PORTAININSERTI PER 14 MM

attacco: 10 mm

	Descrizione	
articolo 2705	CASSETTA METALLICA 35 PEZZI	1



PRO+

- ESAGONO MM 4-5-6-7-8-10-12 LUNGHEZZA 30 MM E 75 MM
- XZN® M. 5-6-8-10-12 LUNGHEZZA 30 MM E 75 MM
- TORX® TX 20-25-30-40-45-50-55 LUNGHEZZA 30 MM E 75 MM
- N. 2 BUSSOLE PORTAININSERTI 3/8"- 1/2"

attacco: 10 mm

	Descrizione	
articolo 2700	CASSETTA METALLICA 40 PEZZI	1



- ESAGONO MM 4-5-6-7-8-10-12 LUNGHEZZA 30 MM
- ESAGONO MM 4-5-6-7-8-10-12 LUNGHEZZA 75 MM
- XZN® M. 5-6-8-10-12 LUNGHEZZA 30 MM
- XZN® M. 5-6-8-10-12 LUNGHEZZA 75 MM
- TORX® TX 20-25-30-40-45-50-55 LUNGHEZZA 30 MM
- TORX® TX 20-25-30-40-45-50-55 LUNGHEZZA 75 MM
- N. 2 BUSSOLE PORTAININSERTI 3/8"-1/2"

attacco: 10 mm

	Descrizione	
articolo 5770	CASSETTA METALLICA 40 PEZZI	1



PRO+ CV

	DESCRIZIONE
articolo BGS 7071	SET 40 PEZZI, INSERTI 10 MM

CARATTERISTICHE

- comprende:
 - 14 inserti Esagonali, lunghezza 30 e 75 mm, nelle seguenti misure: 4 - 5 - 6 - 7 - 8 - 10 - 12 mm
 - 14 inserti Torx, lunghezza 30 e 75 mm, nelle seguenti misure: TX20 - TX25 - TX30 - TX40 - TX45 T50 - T55
 - 14 inserti XZN, lunghezza 30 e 75 mm, nelle seguenti misure: M5 - M6 - M8 - M10 - M12
- adattatori portainseriti 10 mm:
 - att. quadro femmina 1/2"
 - att. quadro femmina 3/8"
- peso 1,9 kg

RICAMBI

	DESCRIZIONE
articolo BGS 7071-LEER	CASSETTA VUOTA

Inserti attacco filettato

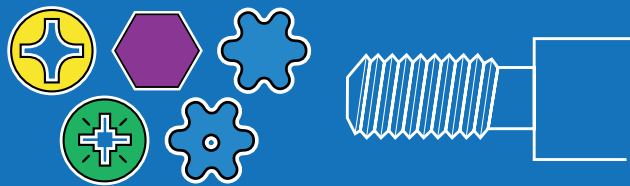

INSERTI ATTACCO FILETTATO

FILETTO M4 **PHILLIPS®**

FRESATO PHILLIPS®
attacco: M 4
impronta: DIN 5260, PH

#FERMEC articolo		Ø mm	L mm	
12109 W	PH 0	Ø 4	42	5
12110 W	PH 1	Ø 5	33	5
12110	PH 1	Ø 5	33	5
12111	PH 1	Ø 6	33	5
12112	PH 2	Ø 6	33	5
12112 W	PH 2	Ø 6	33	5

FILETTO M6 **PHILLIPS®**

FRESATO PHILLIPS®
attacco: M 6
impronta: DIN 5260, PH

#FERMEC articolo		Ø mm	L mm	
12170	PH 2	Ø 8	33	5
212171	PH 3	Ø 8	35	5
12172	PH 2	Ø 8	45	5
12172 R7	PH 2	Ø 7	45	5
12173	PH 3	Ø 8	45	5

FILETTO M5 **POZIDRIV®**

FRESATO POZIDRIV®
attacco: M 5
impronta: DIN 5260, PZ

#FERMEC articolo		Ø mm	L mm	
12130	PZ 1	Ø 6	33	5
PZ2M5D7L31	PZ 2	Ø 7	31	5
12131	PZ 2	Ø 7	33	5
12131 W	PZ 2	Ø 7	33	5
12132	PZ 2	Ø 6	33	5
12151	PZ 1	Ø 6	45	5
12152	PZ 2	Ø 6	45	5
12152 W	PZ 2	Ø 6	45	5
12152 R	PZ 2	Ø 7+Ø5	45	5

FILETTO M5 **PHILLIPS®**

FRESATO PHILLIPS®
attacco: M 5
impronta: DIN 5260, PH

#FERMEC articolo		Ø mm	L mm	
12125	PH 1	Ø 6	33	5
PH2M5D6L31	PH 2	Ø 6	31	5
PH2M5D7L31	PH 2	Ø 7	31	5
12126	PH 2	Ø 7	33	5
12126 W	PH 2	Ø 7	33	5
12127	PH 2	Ø 6	33	5
12127 W	PH 2	Ø 6	33	5
12141	PH 1	Ø 6	45	5
12141 R	PH 1	Ø 4,5	45	5
12142	PH 2	Ø 6	45	5
12142 W	PH 2	Ø 6	45	5
12142 R	PH 2	Ø 7+Ø5	45	5

FILETTO 10/32" **PHILLIPS®**

FRESATO PHILLIPS®
attacco: 10/32"
impronta: DIN 5260, PH

#FERMEC articolo		Ø mm	L mm	
12159	PH 1	Ø 6	45	5
12160	PH 2	Ø 6	45	5
12160 W	PH 2	Ø 6	45	5

FILETTO M6 **POZIDRIV®**

FRESATO POZIDRIV®
attacco: M 6
impronta: DIN 5260, PZ

#FERMEC articolo		Ø mm	L mm	
12180	PZ 2	Ø 8	33	5
212181	PZ 3	Ø 8	33	5
12181	PZ 1	Ø 8	45	5
12182	PZ 2	Ø 8	45	5
12183	PZ 3	Ø 8	45	5

FILETTO M4 **POZIDRIV®**

FRESATO POZIDRIV®
attacco: M 4
impronta: DIN 5260, PZ

#FERMEC articolo		Ø mm	L mm	
12120	PZ 1	Ø 5	33	5
12120 W	PZ 1	Ø 5,5	33	5
12121	PZ 1	Ø 6	33	5
12122	PZ 2	Ø 6	33	5
12122 W	PZ 2	Ø 6	33	5

FILETTO 10/32" **POZIDRIV®**

FRESATO POZIDRIV®
attacco: 10/32"
impronta: DIN 5260, PZ

#FERMEC articolo		Ø mm	L mm	
12162	PZ 1	Ø 6	45	5
12163	PZ 2	Ø 6	45	5

W= ALTA RESISTENZA



FILETTO M4 **ESAGONO**

ESAGONO BRUGOLA
attacco: M 4
impronta: ESAGONO

FEWEC articolo	mm	Ø mm	L mm	
BR20M4D55L33	2	5,5	33	5
BR25M4D55L33	2,5	5,5	33	5
BR30M4D55L33	3	5,5	33	5



ESAGONO

attacco: M 5-6-8-10
impronta: ESAGONO

FEWEC articolo	mm	Filetto	Ø mm	L mm	
507607	7	M 6	10	33	5
508608	8	M 8	12	37	5
510610	10	M 8	16	37	5
513613	13	M 10	19	37	5



FILETTO M6 **TORX®**

TORX®
attacco: M 6
impronta: TORX®

FEWEC articolo	mm	Ø mm	L mm	
TX20M6D8L33	TX 20	8	33	5
TX25M6D8L33	TX 25	8	33	5
TX30M6D8L33	TX 30	8	33	5
TX15M6D8L45	TX 15	8	45	5
TX20M6D8L45	TX 20	8	45	5
TX25M6D8L45	TX 25	8	45	5
TX30M6D8L45	TX 30	8	45	5
TX40M6D8L45	TX 40	8	45	5



FILETTO M5 **ESAGONO**

ESAGONO BRUGOLA
attacco: M 5
impronta: ESAGONO

FEWEC articolo	mm	Ø mm	L mm	
BR30M5D7L33	3	7	33	5
BR40M5D8L33	4	8	33	5
BR30M5D6L45	3	6	45	5
BR40M5D6L45	4	6	45	5
BR50M5D6L45	5	6	45	5



FILETTO M4 **TORX®**

TORX®
attacco: M 4
impronta: TORX®

FEWEC articolo	mm	Ø mm	L mm	
TX8M4D55L33	TX 8	5,5	33	5
TX10M4D55L33	TX 10	5,5	33	5
TX15M4D55L33	TX 15	5,5	33	5
TX20M4D55L33	TX 20	5,5	33	5
TX25M4D55L33	TX 25	5,5	33	5
TX27M4D55L33	TX 27	5,5	33	5
TX30M4D55L33	TX 30	5,5	33	5
TX10M4D5L50	TX 10	5	50	5



FILETTO 10/32" **TORX®**

TORX®
attacco: 10/32"
impronta: TORX®

FEWEC articolo	mm	Ø mm	L mm	
TX101032D6L45	TX 10	6	45	5
TX151032D6L45	TX 15	6	45	5
TX201032D6L45	TX 20	6	45	5
TX251032D6L45	TX 25	6	45	5
TX301032D6L45	TX 30	6	45	5



FILETTO M6 **ESAGONO**

ESAGONO BRUGOLA
attacco: M 6
impronta: ESAGONO

FEWEC articolo	mm	Ø mm	L mm	
BR40M6D10L33	4	10	33	5
BR50M6D10L33	5	10	33	5
BR60M6D10L33	6	10	33	5
BR50M6D8L45	5	8	45	5



FILETTO M5 **TORX®**

TORX®
attacco: M 5
impronta: TORX®

FEWEC articolo	mm	Ø mm	L mm	
TX10M5D7L33	TX 10	7	33	5
TX15M5D7L33	TX 15	7	33	5
TX20M5D7L33	TX 20	7	33	5
TX25M5D7L33	TX 25	7	33	5
TX27M5D7L33	TX 27	7	33	5
TX30M5D7L33	TX 30	7	33	5
TX40M5D7L33	TX 40	7	33	5
TX8M5D6L45	TX 8	6	45	5
TX10M5D6L45	TX 10	6	45	5
TX15M5D6L45	TX 15	6	45	5
TX20M5D6L45	TX 20	6	45	5
TX25M5D6L45	TX 25	6	45	5
TX27M5D6L45	TX 27	6	45	5
TX30M5D6L45	TX 30	6	45	5



FILETTO M4 **TORX® CON FORO**

TORX® C/FORO
attacco: M 4
impronta: TORX® C/FORO

FEWEC articolo	mm	Ø mm	L mm	
TH10M4D55L33	TH 10	5,5	33	5
TH15M4D55L33	TH 15	5,5	33	5

Inserti Attacco 5/16"

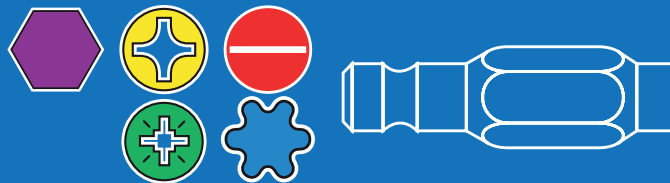

DESOUTTER 5/16"

ADATTATORE PER BUSSOLE
attacco: 5/16"

articolo			L mm	
13101	1/4"	Perno	50	1
113101	1/4"	Perno	100	1
113103	3/8"	Perno	50	1
113104	3/8"	Perno	100	1
13103	1/2"	Perno	75	1

DESOUTTER 5/16"

TORX®

attacco: 5/16"
impronta: TORX®

articolo		L mm	
13310	TX 10	50	5
13315	TX 15	50	5
13320	TX 20	50	5
13325	TX 25	50	5
13327	TX 27	50	5
13330	TX 30	50	5
13340	TX 40	50	5

DESOUTTER 5/16"

ESAGONO

BRUGOLA TCCE
attacco: 5/16"
impronta: ESAGONO

articolo	mm	L mm	
13091	2	50	5
13092	2,5	50	5
13093	3	50	5
13094	4	50	5
13095	5	50	5
13096	6	50	5
13097	7	50	5
13098	8	50	5

DESOUTTER 5/16"

TAGLIO

attacco: 5/16"
impronta: DIN 5264, C

articolo	mm	L mm	
13063	0,6 x 3,5	50	5
13064	0,6 x 4,5	50	5
13066	0,8 x 5,5	50	5
13069	1,2 x 8	50	5
13070	1,6 x 8	50	5

DESOUTTER 5/16"

POZIDRIV®

attacco: 5/16"
impronta: DIN 5260, PZ

articolo		L mm	
13080	PZ 1	50	5
13081	PZ 2	50	5
13082	PZ 3	50	5
13083	PZ 4	50	5
13080- 75	PZ 1	75	5
13081- 75	PZ 2	75	5
13082- 75	PZ 3	75	5
13080- 100	PZ 1	100	5
13081- 100	PZ 2	100	5
13082- 100	PZ 3	100	5

DESOUTTER 5/16"

PHILLIPS®

attacco: 5/16"
impronta: DIN 5260, PH

articolo		L mm	
13076	PH 1	50	5
13077	PH 2	50	5
13078	PH 3	50	5
13079	PH 4	50	5
13076- 75	PH 1	75	5
13077- 75	PH 2	75	5
13078- 75	PH 3	75	5
13076- 100	PH 1	100	5
13077- 100	PH 2	100	5
13078- 100	PH 3	100	5

INSERTI ATTACCO DESOUTTER 5/16"



Inserti Attacco 7/16"

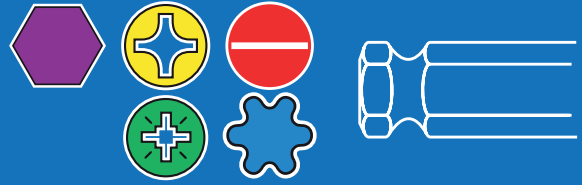

INSERTI ATTACCO 7/16"

7/16"

ADATTATORE PER BUSSOLE
attacco: 7/16"

FEIMEC articolo			L mm	
113401	1/4"	Perno	50	1
113402	3/8"	Perno	75	1
13403	3/8"	Perno	125	1
13404	1/2"	Perno	75	1
13405	1/2"	Perno	125	1
13406	1/2"	Perno	200	1

7/16"

PHILLIPS®
attacco: 7/16"
impronta: DIN 5260, PH

FEIMEC articolo		L mm	
13377	PH 2	75	5
13378	PH 3	75	5
13379	PH 4	75	5

7/16"

POZIDRIV®
attacco: 7/16"
impronta: DIN 5260, PZ

FEIMEC articolo		L mm	
13381	PZ 2	75	5
13382	PZ 3	75	5
13383	PZ 4	75	5

7/16"

ESAGONO
BRUGOLA TCCE
attacco: 7/16"
impronta: ESAGONO

FEIMEC articolo	mm	L mm	
13394	4	55	5
13395	5	55	5
13396	6	55	5
13397	7	55	5
13398	8	55	5
13399	10	55	5
13400	12	55	5
13401	14	55	5
13412	5	90	5
13413	6	90	5
13414	8	90	5
13415	10	90	5
13416	12	90	5
13417	14	90	5
13513	6	125	5
13514	8	125	5

7/16"

TORX®
attacco: 7/16"
impronta: TX

FEIMEC articolo		L mm	
13630	TX 30	75	5
13640	TX 40	75	5
136455	TX 45	75	5
13650	TX 50	75	5
13655	TX 55	75	5

JAPAN

7/16"

ESAGONO

INSERTO CON MASCHIO ESAGONALE
attacco: 7/16"
impronta: ESAGONO

Koken

articolo	mm	L mm	
183H-35-3	3	35	1
183H-35-4	4	35	1
183H-35-5	5	35	1
183H-35-6	6	35	1
183H-35-7 <small>NEW</small>	7	35	1
183H-35-8	8	35	1
183H-35-9	9	35	1
183H-35-10	10	35	1
183H-35-11	11	35	1
183H-35-12	12	35	1
183H-35-14	14	35	1
183H-35-16	16	35	1
183H-35-17	17	35	1
183H-35-18	18	35	1
183H-35-19	19	35	1
183H-75-3	3	75	1
183H-75-4	4	75	1
183H-75-5	5	75	1
183H-75-6	6	75	1
183H-75-7	7	75	1
183H-75-8	8	75	1
183H-75-10	10	75	1
183H-75-11	11	75	1
183H-75-12	12	75	1
183H-75-14	14	75	1
183H-150-4	4	150	1
183H-150-5	5	150	1
183H-150-6	6	150	1
183H-150-8	8	150	1
183H-150-10	10	150	1
183H-150-12	12	150	1

Chiavi a bussola

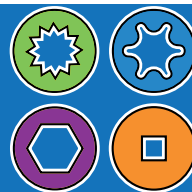

CHIAVI A BUSSOLA

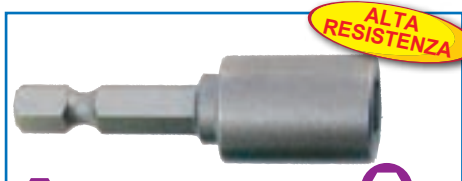

ESECUZIONE CHROM-VANADIUM
ALTA RESISTENZA CON AVVITATORI A MASSA BATTENTE

attacco: DIN 3126, E 6,35
impronta: ESAGONO

FEIMEC articolo	mm	L mm	
2192 - 4	4	50	5
2192 - 4,5	4,5	50	5
2192 - 5	5	50	5
2192 - 5,5	5,5	50	5
2192 - 6	6	50	5
2192 - 7	7	50	5
2192 - 8	8	50	5
2192 - 9	9	50	5
2192 - 10	10	50	5
2192 - 11	11	50	5
2192 - 12	12	50	5
2192 - 13	13	50	5
2192 - 14	14	50	5
2192 - 15	15	50	5
2192 - 16	16	50	5
2192 - 17	17	50	5
21193 - 5	5	75	5
21193 - 5,5	5,5	75	5
21193 - 6	6	75	5
21193 - 7	7	75	5
21193 - 8	8	75	5
21193 - 9	9	75	5
21193 - 10	10	75	5
21193 - 12	12	75	5
21193 - 13	13	75	5
21193 - 14	14	75	5
21194 - 5	5	100	5
21194 - 5,5	5,5	100	5
21194 - 6	6	100	5
21194 - 7	7	100	5
21194 - 8	8	100	5
21194 - 9	9	100	5
21194 - 10	10	100	5
21194 - 12	12	100	5
21194 - 13	13	100	5
21194 - 14	14	100	5
21194 - 15	15	100	5
21194 - 17	17	100	5
2192 - 1/4"	1/4"	50	5
2192 - 5/16"	5/16"	50	5
2192 - 3/8"	3/8"	50	5

POLLICI

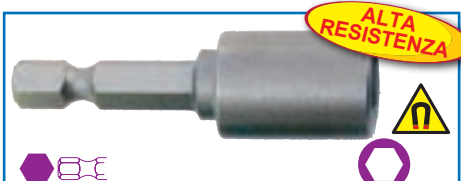

ESECUZIONE CHROM-VANADIUM
ALTA RESISTENZA CON AVVITATORI A MASSA BATTENTE - MAGNETICA

attacco: DIN 3126, E 6,35
impronta: ESAGONO

FEIMEC articolo	mm	L mm	
2192 - 4 M	4	50	5
2192 - 4,5 M	4,5	50	5
2192 - 5 M	5	50	5
2192 - 5,5 M	5,5	50	5
2192 - 6 M	6	50	5
2192 - 7 M	7	50	5
2192 - 8 M	8	50	5
2192 - 9 M	9	50	5
2192 - 10 M	10	50	5
2192 - 11 M	11	50	5
2192 - 12 M	12	50	5
2192 - 13 M	13	50	5
2192 - 14 M	14	50	5
2192 - 15 M	15	50	5
2192 - 17 M	17	50	5
21193 - 5 M	5	75	5
21193 - 5,5 M	5,5	75	5
21193 - 6 M	6	75	5
21193 - 7 M	7	75	5
21193 - 8 M	8	75	5
21193 - 9 M	9	75	5
21193 - 10 M	10	75	5
21193 - 12 M	12	75	5
21193 - 13 M	13	75	5
21193 - 14 M	14	75	5
21194 - 5 M	5	100	5
21194 - 5,5 M	5,5	100	5
21194 - 6 M	6	100	5
21194 - 7 M	7	100	5
21194 - 8 M	8	100	5
21194 - 9 M	9	100	5
21194 - 10 M	10	100	5
21194 - 12 M	12	100	5
21194 - 13 M	13	100	5
21194 - 14 M	14	100	5
21194 - 15 M	15	100	5
21194 - 17 M	17	100	5
2192 - 1/4" M	1/4"	50	5
2192 - 5/16" M	5/16"	50	5
2192 - 3/8" M	3/8"	50	5

POLLICI

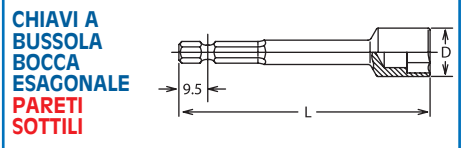

CHIAVI A BUSSOLA
BOCCA ESAGONALE
PARETI SOTTILI

attacco: DIN 3126, E 6,35
impronta: ESAGONO

Koken articolo	mm	D mm	L mm	
113-5,5	5,5	9	50	5
113-6	6	10	50	5
113-7	7	11	50	5
113-8	8	12	50	5
113-10	10	14	50	5
113-11 NEW	11	16	50	5
113-12	12	17	50	5
113-13	13	18	50	5
113-14	14	19	50	5

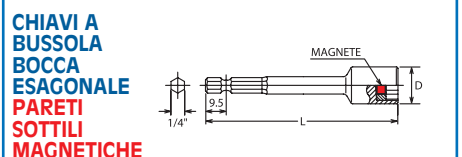

CHIAVI A BUSSOLA
BOCCA ESAGONALE
PARETI SOTTILI
MAGNETICHE

attacco: DIN 3126, E 6,35
impronta: ESAGONO

Koken articolo	mm	D mm	L mm	
115-5,5	5,5	9	50	5
115-6	6	10	50	5
115-7	7	11	50	5
115-8	8	12	50	5
115-10	10	14	50	5
115-11 NEW	11	16	50	5
115-12	12	17	50	5
115-13	13	18	50	5
115-14	14	19	50	5



CHIAVI A BUSSOLA BOCCA ESAGONALE LUNGHE

attacco: DIN 3126, E 6,35
impronta: ESAGONO

<i>Koken</i> articolo	mm	D mm	L mm	5
113-75-7	7	11.5	75	5
113-75-8	8	12.7	75	5
113-75-10	10	14.5	75	5
113-75-12	12	17	75	5
113-75-13	13	18	75	5
113-75-14	14	19	75	5
113-100-7	7	11.5	100	5
113-100-8	8	12.7	100	5
113-100-10	10	14.5	100	5
113-100-12	12	17	100	5
113-100-13	13	18	100	5
113-100-14	14	19	100	5
113-150-7	7	11.5	150	5
113-150-8	8	12.7	150	5
113-150-10	10	14.5	150	5
113-150-12	12	17	150	5
113-150-13	13	18	150	5
113-150-14	14	19	150	5
113-200-7	7	11.5	200	5
113-200-8	8	12.7	200	5
113-200-10	10	14.5	200	5
113-200-12	12	17	200	5
113-200-13	13	18	200	5
113-200-14	14	19	200	5
113-250-7	7	11.5	250	5
113-250-8	8	12.7	250	5
113-250-10	10	14.5	250	5
113-250-12	12	17	250	5
113-250-13	13	18	250	5
113-250-14	14	19	250	5



CHIAVI A BUSSOLA BOCCA ESAGONALE LUNGHE MAGNETICHE

attacco: DIN 3126, E 6,35
impronta: ESAGONO

<i>Koken</i> articolo	mm	D mm	L mm	5	MAGNETE
115-75-7	7	11.5	75	5	
115-75-8	8	12.7	75	5	
115-75-10	10	14.5	75	5	
115-75-12	12	17	75	5	
115-75-13	13	18	75	5	
115-75-14	14	19	75	5	
115-100-7	7	11.5	100	5	
115-100-8	8	12.7	100	5	
115-100-10	10	14.5	100	5	
115-100-12	12	17	100	5	
115-100-13	13	18	100	5	
115-100-14	14	19	100	5	
115-150-7	7	11.5	150	5	
115-150-8	8	12.7	150	5	
115-150-10	10	14.5	150	5	
115-150-12	12	17	150	5	
115-150-13	13	18	150	5	
115-150-14	14	19	150	5	
115-200-7	7	11.5	200	5	
115-200-8	8	12.7	200	5	
115-200-10	10	14.5	200	5	
115-200-12	12	17	200	5	
115-200-13	13	18	200	5	
115-200-14	14	19	200	5	
115-250-7	7	11.5	250	5	
115-250-8	8	12.7	250	5	
115-250-10	10	14.5	250	5	
115-250-12	12	17	250	5	
115-250-13	13	18	250	5	
115-250-14	14	19	250	5	

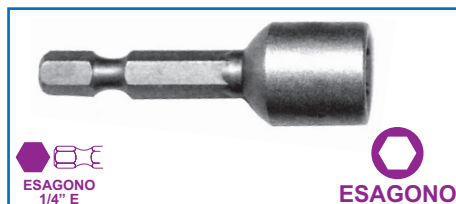

CHIAVI A BUSSOLA ESAGONALI "ECONOMICHE"

attacco: DIN 3126, E 6,35
impronta: ESAGONO

<i>FERMEC</i> articolo	mm	L mm	5
1874-5,5	5,5	42	5
1874-6	6	42	5
1874-7	7	42	5
1874-8	8	42	5
1874-9	9	42	5
1874-10	10	45	5
1874-11	11	45	5
1874-12	12	45	5
1874-13	13	45	5
1874-14	14	45	5
1874-17	17	45	5

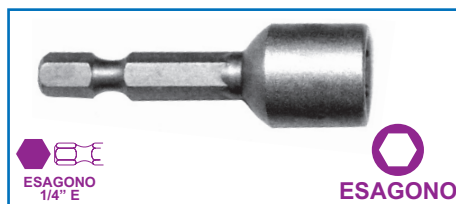

CHIAVI A BUSSOLA ESAGONALI "ECONOMICHE"

CON MAGNETE EXTRA FORTE

attacco: DIN 3126, E 6,35
impronta: ESAGONO

<i>FERMEC</i> articolo	mm	L mm	5	MAGNETE EXTRA FORTE
1870-4 M	4	42	5	
1870-5 M	5	42	5	
1870-5,5 M	5,5	42	5	
1870-6 M	6	42	5	
1870-7 M	7	42	5	
1870-8 M	8	42	5	
1870-9 M	9	42	5	
1870-10 M	10	45	5	
1870-11 M	11	45	5	
1870-12 M	12	45	5	
1870-13 M	13	45	5	
1870-14 M	14	45	5	
1870-17 M	17	45	5	



CON RIVESTIMENTO ANTI-GRAFFIO

CHIAVI A BUSSOLA

BOCCA

ESAGONALE

LUNGHE CON RIVESTIMENTO IN PLASTICA ANTIGRAFFIO

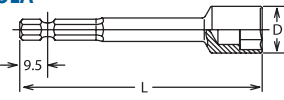

attacco: DIN 3126, E 6,35
impronta: ESAGONO

Kokon articolo	mm	D mm	L mm	
113-75-8 SV	8	15.1	75	5
113-75-10 SV	10	16.9	75	5
113-75-12 SV	12	19.4	75	5
113-75-13 SV	13	20.4	75	5
113-100-8 SV	8	15.1	100	5
113-100-10 SV	10	16.9	100	5
113-100-12 SV	12	19.4	100	5
113-100-13 SV	13	20.4	100	5
113-150-8 SV	8	15.1	150	5
113-150-10 SV	10	16.9	150	5
113-150-12 SV	12	19.4	150	5
113-150-13 SV	13	20.4	150	5



CON RIVESTIMENTO ANTI-GRAFFIO

CHIAVI A BUSSOLA

BOCCA

ESAGONALE

LUNGHE

MAGNETICHE

CON RIVESTIMENTO IN PLASTICA ANTIGRAFFIO

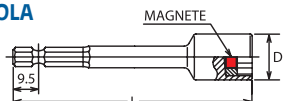

attacco: DIN 3126, E 6,35
impronta: ESAGONO

Kokon articolo	mm	D mm	L mm		
115-75-8 SV	8	15.1	75	5	
115-75-10 SV	10	16.9	75	5	
115-75-12 SV	12	19.4	75	5	
115-75-13 SV	13	20.4	75	5	
115-100-8 SV	8	15.1	100	5	
115-100-10 SV	10	16.9	100	5	
115-100-12 SV	12	19.4	100	5	
115-100-13 SV	13	20.4	100	5	
115-150-8 SV	8	15.1	150	5	
115-150-10 SV	10	16.9	150	5	
115-150-12 SV	12	19.4	150	5	
115-150-13 SV	13	20.4	150	5	



CHIAVI A BUSSOLA ESAGONALI "ECONOMICHE"

attacco: DIN 3126, E 6,35
impronta: ESAGONO

FERMEC articolo	mm	L mm	
2874-5,5	5,5	65	5
2874-6	6	65	5
2874-7	7	65	5
2874-8	8	65	5
2874-10	10	65	5
2874-11	11	65	5
2874-12	12	65	5
2874-13	13	65	5
2874-17	17	65	5
2874-19	19	65	5



CHIAVI A BUSSOLA ESAGONALI "ECONOMICHE"

CON MAGNETE EXTRA FORTE



attacco: DIN 3126, E 6,35
impronta: ESAGONO

FERMEC articolo	mm	L mm		
2870-5,5 M	5,5	65	5	
2870-6 M	6	65	5	
2870-7 M	7	65	5	
2870-8 M	8	65	5	
2870-10 M	10	65	5	
2870-11 M	11	65	5	
2870-12 M	12	65	5	
2870-13 M	13	65	5	
2870-17 M	17	65	5	
2870-19 M	19	65	5	



SET 6 PEZZI CHIAVI A BUSSOLA MAGNETICHE - SERIE 1870



attacco: DIN 3126, E 6,35
impronta: ESAGONO

FERMEC articolo	Descrizione	
18700	SET 6 PEZZI 5,5-6-7-8-10-13 mm	1

MILLIMETRI
E POLLICI



NEW



BCS articolo	DESCRIZIONE
BCS 67314	SET 14 PEZZI, CHIAVI A BUSSOLA, MISURE METRICHE 5-12 MM, MISURE IN POLLICI 3/16" - 7/16"

CARATTERISTICHE
• attacco 1/4"
• comprende: - 7 chiavi a bussola metriche: 5 - 5.5 - 6 - 7 - 8 - 10 - 12 mm - 7 chiavi a bussola in pollici: 3/16" - 1/4" - 9/32" - 5/16" - 11/32" - 3/8" - 7/16"
• peso: 230 g



BGS
articolo
BGS 67308

DESCRIZIONE
SET 8 PEZZI,
CHIAVI A BUSSOLA,
5-13 MM

CARATTERISTICHE

- attacco 1/4"
- bussole Esagonali misure: 5-6-7-8-9-10-12-13 mm
- peso 150 g



BGS
articolo
BGS 2762

DESCRIZIONE
SET 8 PEZZI,
CHIAVI A BUSSOLA,
ECONOMICHE,
6-13 MM

CARATTERISTICHE

- bussole esagonali misure: 6 - 7 - 8 - 9 - 10 - 11 - 12 - 13 mm
- attacco esagonale 1/4"
- lunghezza 100 mm
- peso 450 g



BGS
articolo
BGS 2758

DESCRIZIONE
SET 8 PEZZI,
CHIAVI A BUSSOLA,
CON MAGNETE,
6-13 MM

CARATTERISTICHE

- bussole esagonali misure: 6 - 7 - 8 - 9 - 10 - 11 - 12 - 13 mm
- attacco esagonale 1/4"
- lunghezza 65 mm
- peso 330 g



BGS
articolo
BGS 2759

DESCRIZIONE
SET 8 PEZZI,
CHIAVI A BUSSOLA,
ECONOMICHE,
6-13 MM

CARATTERISTICHE

- bussole esagonali misure: 6 - 7 - 8 - 9 - 10 - 11 - 12 - 13 mm
- attacco esagonale 1/4"
- lunghezza 100 mm
- peso 450 g

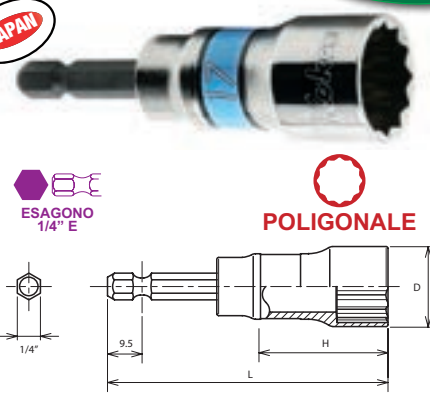

KOKEN
articolo
BD 014 SE-8

DESCRIZIONE
POLIGONALE DA MM 11 PER FISSAGGIO
VITI "KOVERPLAST" SU LAMIERE
PREVERNICIATE

CARATTERISTICHE

- attacco: DIN 3126, E 6,35
- impronta: Poligonale

articolo	mm	D mm	H mm	L mm	
BD 014 SE-8	8	12	36	77	1
BD 014 SE-10	10	14	36	77	1
BD 014 SE-12	12	16,5	36	77	1
BD 014 SE-13	13	17,5	36	77	1
BD 014 SE-14	14	19	36	77	1
BD 014 SE-17	17	22,5	36	77	1
BD 014 SE-19	19	24,5	36	77	1
BD 014 SE-21	21	27	34	77	1
BD 014 SE-22	22	28	34	77	1
BD 014 SE-24	24	30,3	34	77	1
BD 014 E-8	8	12	63	104	1
BD 014 E-10	10	14	63	104	1
BD 014 E-12	12	16,5	63	104	1
BD 014 E-13	13	17,5	63	104	1
BD 014 E-14	14	19	63	104	1
BD 014 E-17	17	22,5	60	104	1
BD 014 E-19	19	24,5	60	104	1
BD 014 E-21	21	27	60	104	1
BD 014 E-22	22	28	60	104	1
BD 014 E-24	24	30,3	60	104	1



FERMEC
articolo
192-11-DSKT

DESCRIZIONE
POLIGONALE DA MM 11 PER FISSAGGIO
VITI "KOVERPLAST" SU LAMIERE
PREVERNICIATE

CARATTERISTICHE

- attacco: DIN 3126, E 6,35
- impronta: Poligonale

articolo	mm	L mm	
192-11-DSKT	11	50	5

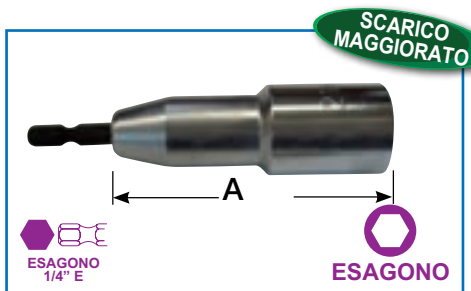

CHIAVI A BUSSOLA ESAGONALI ATT. 1/4"
CON SCARICO INTERNO 60 MM
 attacco: DIN 3126, E 6,35
 impronta: ESAGONO

FEHMEC articolo	mm	scarico "A" mm	L mm	
5594 - 8	8	60	110	5
5594 - 10	10	60	110	5
5594 - 12	12	60	110	5
5594 - 13	13	60	110	5
5594 - 14	14	60	110	5
5594 - 17	17	60	110	5
5594 - 19	19	60	110	5
5594 - 21	21	60	110	5
5594 - 24	24	60	110	5

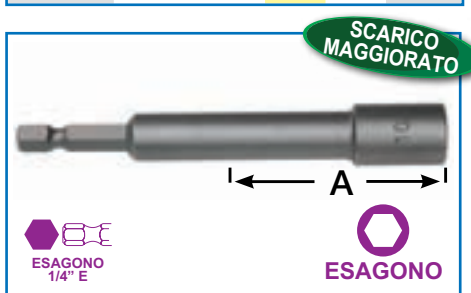

CHIAVI A BUSSOLA ESAGONALI AD ALTA RESISTENZA CON SCARICO MAGGIORATO ESECUZIONE INTEGRALE
 attacco: DIN 3126, E 6,35
 impronta: ESAGONO

FEHMEC articolo	mm	scarico "A" mm	L mm	
5194 - 5,5	5,5	50	100	5
5194 - 7	7	50	100	5
5194 - 8	8	50	100	5
5194 - 10	10	50	100	5
5194 - 13	13	50	100	5
5194 - 17	17	50	100	5

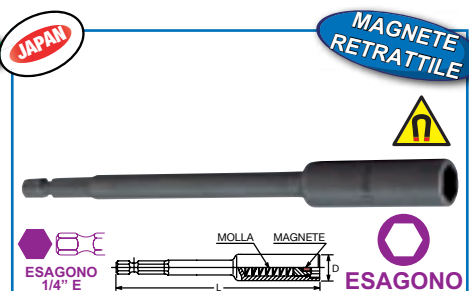

CON MAGNETE RETRATTILE SCARICO INTERNO 25 MM
 attacco: DIN 3126, E 6,35
 impronta: ESAGONO

Koken articolo	mm	D mm	L mm	
115G-75-5,5	5,5		75	5
115G-75-7	7	11,5	75	5
115G-75-8	8	12,7	75	5
115G-75-10	10	14,5	75	5
115G-75-12	12	17	75	5
115G-75-13	13	18	75	5
115G-75-14	14	19	75	5
115G-100-5,5	5,5		100	5
115G-100-7	7	11,5	100	5
115G-100-8	8	12,7	100	5
115G-100-10	10	14,5	100	5
115G-100-12	12	17	100	5
115G-100-13	13	18	100	5
115G-100-14	14	19	100	5
115G-150-7	7	11,5	150	5
115G-150-8	8	12,7	150	5
115G-150-10	10	14,5	150	5
115G-150-12	12	17	150	5
115G-150-13	13	18	150	5
115G-150-14	14	19	150	5
115G-200-7	7	11,5	200	5
115G-200-8	8	12,7	200	5
115G-200-10	10	14,5	200	5
115G-200-12	12	17	200	5
115G-200-13	13	18	200	5
115G-200-14	14	19	200	5
115G-250-8	8	12,7	250	5
115G-250-10	10	14,5	250	5
115G-250-12	12	17	250	5
115G-250-13 NEW	13	18	250	5



CON RIVESTIMENTO ANTI-GRAFFIO
MAGNETE RETRATTILE CON RIVESTIMENTO IN PLASTICA ANTIGRAFFIO
 attacco: DIN 3126, E 6,35
 impronta: ESAGONO

Koken articolo	mm	D mm	L mm	
115G-100-8 FR	8	15.1	100	1
115G-100-10 FR	10	16.9	100	1
115G-100-12 FR	12	19.3	100	1
115G-100-13 FR	12	20.4	100	1
115G-100-14 FR	14	21.3	100	1
115G-150-8 FR	8	15.1	150	1
115G-150-10 FR	10	16.9	150	1
115G-150-12 FR	12	19.3	150	1
115G-150-13 FR	12	20.4	150	1
115G-150-14 FR	14	21.3	150	1
115G-200-8 FR	8	15.1	200	1
115G-200-10 FR	10	16.9	200	1
115G-200-12 FR	12	19.3	200	1
115G-200-13 FR	12	20.4	200	1
115G-200-14 FR	14	21.3	200	1



JAPAN



ESAGONO 1/4" E

ESAGONO

CHIAVI A BUSSOLA BOCCA ESAGONALE SNODATE LUNGHE

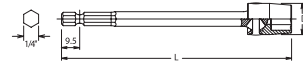

attacco: DIN 3126, E 6,35
impronta: ESAGONO

Koken articolo	mm	D mm	L mm	
113-UN-100-8	8	13	100	5
113-UN-100-10	10	15	100	5
113-UN-100-12	12	17	100	5
113-UN-100-13	13	18	100	5
113-UN-100-14	14	19.2	100	5
113-UN-150-8	8	13	150	5
113-UN-150-10	10	15	150	5
113-UN-150-12	12	17	150	5
113-UN-150-13	13	18	150	5
113-UN-150-14	14	19.2	150	5
113-UN-200-8	8	13	200	5
113-UN-200-10	10	15	200	5
113-UN-200-12	12	17	200	5
113-UN-200-13	13	18	200	5
113-UN-200-14	14	19.2	200	5

CON SFERA



ESAGONO 1/4"

ESAGONO

CHIAVE A BUSSOLA ESAGONALE

attacco: 1/4" (6,3 mm) con sfera
impronta: ESAGONO

FEFMEC articolo	mm	L mm	
116 - 7	7	22	5
116 - 8	8	22	5
116 - 10	10	22	5

ETERNIT



SDS plus

QUADRO FEMMINA PER VITI "ETERNIT"

attacco: SDS PLUS
impronta: QUADRA

FEFMEC articolo	mm	L mm	
SDS-11-VKT	11	75	5

ESAGONO 1/4" E

TORX®

PARETI SOTTILI

attacco: DIN 3126, E 6,35
impronta: TORX®

Koken articolo		L mm	Ø	
113-E 4	E 4	50	6.1	5
113-E 5	E 5	50	7.5	5
113-E 6	E 6	50	8.3	5
113-E 7	E 7	50	8.8	5
113-E 8	E 8	50	10.1	5
113-E 10	E 10	50	12	5

JAPAN

SFERE DI TENUTA



X VITI INOX

ESAGONO 1/4" E

ESAGONO

CHIAVI A BUSSOLA BOCCA ESAGONALE CON SFERE DI BLOCCAGGIO



attacco: DIN 3126, E 6,35
impronta: ESAGONO

Koken articolo	mm	D mm	l mm	L mm	
113-7-2B	7	11	5	50	5
113-8-2B	8	12	6	50	5
113-10-2B	10	14.2	7	50	5
113-13-2B	13	18	8	50	5
113-3/8-2B	3/8	14.2	7	50	5

POLLICI

ETERNIT



ESAGONO 1/4" E

QUADRO FEMMINA PER VITI "ETERNIT"

attacco: DIN 3126, E 6,35
impronta: QUADRA

FEFMEC articolo	mm	L mm	
192-11-VKT	11	65	5
192-12-VKT	12	65	5
192-13-VKT	13	65	5
21194-13-VKT	13	SCARICATO 50 MM	5

3 CHIAVI A BUSSOLA



DESOUTTER
5/16"

ESAGONO

CHIAVI A BUSSOLA ESAGONALI AD ALTA RESISTENZA

attacco: 5/16"

impronta: ESAGONO

FEIMEC articolo	mm	L mm	
193-5,5	5,5	50	5
193-6	6	50	5
193-7	7	50	5
193-8	8	50	5
193-9	9	50	5
193-10	10	50	5
193-11	11	50	5
193-12	12	50	5
193-13	13	50	5
193-14	14	50	5
193-17	17	50	5
193-6-75	6	75	5
193-7-75	7	75	5
193-8-75	8	75	5
193-10-75	10	75	5
193-12-75	12	75	5
193-13-75	13	75	5
193-14-75	14	75	5
193-17-75	17	75	5



DESOUTTER
5/16"



ESAGONO

CHIAVI A BUSSOLA ESAGONALI AD ALTA RESISTENZA - MAGNETICHE

attacco: 5/16"

impronta: ESAGONO

FEIMEC articolo	mm	L mm	
193-5,5 M	5,5	50	5
193-6 M	6	50	5
193-7 M	7	50	5
193-8 M	8	50	5
193-9 M	9	50	5
193-10 M	10	50	5
193-11 M	11	50	5
193-12 M	12	50	5
193-13 M	13	50	5
193-14 M	14	50	5
193-17 M	17	50	5
193-6-75 M	6	75	5
193-7-75 M	7	75	5
193-8-75 M	8	75	5
193-10-75 M	10	75	5
193-12-75 M	12	75	5
193-13-75 M	13	75	5
193-14-75 M	14	75	5
193-17-75 M	17	75	5

JAPAN



FEIN 7 mm.

ESAGONO



CHIAVI A BUSSOLA BOCCA ESAGONALE CON ATTACCO FEIN MAGNETICHE

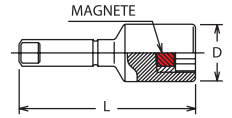

attacco: FEIN

impronta: ESAGONO

Koken articolo	mm	D mm	L mm	
119-5,5	5,5	9	50	5
119-6	6	10	50	5
119-7	7	11	50	5
119-8	8	12	50	5
119-10	10	14	50	5
119-12	12	17	50	5
119-13	13	18	50	5
119-1/4	1/4"	10	50	5
119-5/16	5/16"	12	50	5
119-3/8	3/8"	14	50	5

POLLICI

NOTE

Programma in blister



ESAGONO
1/4" E

SCATOLA 10 BLISTER

Descrizione		
PORTA INSERTI MAGNETICO mm 60	10	



ESAGONO
1/4" C

BLISTER 2 INSERTI A TAGLIO
SCATOLA 10 BLISTER

Descrizione		
5,5 MM	10	
6 MM	10	
6,5 MM	10	



ESAGONO
1/4" C

BLISTER 2 INSERTI POZIDRIV®
SCATOLA 10 BLISTER

Descrizione		
PZ 1	10	
PZ 2	10	
PZ 3	10	



ESAGONO
1/4" C

SCATOLA 10 BLISTER

Descrizione		
CONFEZIONE 6 INSERTI MISTI	10	



ESAGONO
1/4" C

BLISTER 2 INSERTI PHILLIPS®
SCATOLA 10 BLISTER

Descrizione		
PH 1	10	
PH 2	10	
PH 3	10	



ESAGONO
1/4" C

BLISTER 2 INSERTI TORX®
SCATOLA 10 BLISTER

Descrizione		
TX 10	10	
TX 15	10	
TX 20	10	
TX 25	10	
TX 27	10	
TX 30	10	
TX 40	10	



ESAGONO
1/4" C

TAGLIO - PHILLIPS® PH2/MM 5 - SCATOLA
10 BLISTER

Descrizione		
CONFEZIONE 1 INSERTO DOPPIO	10	



ESAGONO
1/4" C

- TAGLIO - PHILLIPS® PH 1-2-3/4-5-7 MM.
- TAGLIO - POZIDRIV® PZ 1-2-3/4-5-7 MM.

Descrizione		€uro
CONFEZIONE 3 INSERTI DOPPI PH	10	
CONFEZIONE 3 INSERTI DOPPI PZ	10	



USH
GERMANY

BOX

GERMANY



DISPONIBILE ESPOSITORE
DA BANCO DA 10 PEZZI



- 2 INSERTI A TAGLIO
- 2 INSERTI PH1 - PH2
- 2 INSERTI PZ1 - PZ2
- + PORTA INSERTI **MAGNETICO**

attacco: 1/4"

FEEMEC articolo	Descrizione	ESAGONO 1/4"
6001	BOX PLASTICA	1/10

GERMANY



DISPONIBILE ESPOSITORE
DA BANCO DA 10 PEZZI



- 6 INSERTI TORX® C/FORO: 10-15-20-25-30-40
- + PORTA INSERTI **MAGNETICO**

attacco: 1/4"

FEEMEC articolo	Descrizione	ESAGONO 1/4"
6026	BOX PLASTICA	1/10



DISPONIBILE ESPOSITORE
DA BANCO DA 10 PEZZI



- BOX 12 PEZZI
- INSERTI PH - PZ - TAGLIO "EXTRA HARD"
- PORTA INSERTI **MAGNETICO**

attacco: 1/4"

FEEMEC articolo	Descrizione	ESAGONO 1/4"
7000	BOX PLASTICA	1/10

GERMANY



DISPONIBILE ESPOSITORE
DA BANCO DA 10 PEZZI



- 6 INSERTI TORX®: 10-15-20-25-30-40
- + PORTA INSERTO **MAGNETICO**

attacco: 1/4"

FEEMEC articolo	Descrizione	ESAGONO 1/4"
6021	BOX PLASTICA	1/10

GERMANY



DISPONIBILE ESPOSITORE
DA BANCO DA 10 PEZZI



- 6 INSERTI BRUGOLA: MM 2-2,5-3-4-5-6
- + 1 PORTA INSERTO **MAGNETICO**

attacco: 1/4"

FEEMEC articolo	Descrizione	ESAGONO 1/4"
6091	BOX PLASTICA	1/10



DISPONIBILE ESPOSITORE
DA BANCO DA 10 PEZZI



- BOX 12 PEZZI
- INSERTI TORX® 10-15-20-25-27-30-40
- PORTA INSERTI **MAGNETICO**

attacco: 1/4"

FEEMEC articolo	Descrizione	ESAGONO 1/4"
7020	BOX PLASTICA	1/10



ESAGONO 1/4" ESAGONO TORX®

- BOX 32 PZ INSERTI TESTA SFERICA L. 25 MM
- N. 10 INSERTI METRICI: 1,5-2-2,5-3-4-5-6-7-8; 10 MM
- N. 10 INSERTI POLLICI: 1/16"; 5/64"; 3/32"; 7/64"; 1/8"; 9/64"; 5/32"; 3/16"; 7/32"; 1/4"
- N. 10 INSERTI TORX: TX8; TX10; TX15; TX20; TX25; TX27; TX30; TX40; TX45; TX50

attacco: 1/4"

FEIMEC articolo	Descrizione	Immagine	Quantità
BIT 32 TS	BOX PLASTICA		1



- BOX 36 PEZZI
- INSERTI PH - PZ - TAGLIO - BRUGOLA - TORX® - TORX® C/FORO - XZN®
- 1 CRICCHETTO PORTA INSERTI
- 1 PORTA INSERTO **MAGNETICO** SGANCIO RAPIDO

attacco: 1/4"

FEIMEC articolo	Descrizione	Immagine	Quantità
BIT-36	BOX PLASTICA		1
BIT-36 E	ESPOSITORE 6 BOX		1



- BOX 36 PEZZI
- TX 6 - 7 - 8 - 10 - 15 - 20 - 25 - 27 - 30 - 40 - 45
- INSERTI TORX® - TORX® C/FORO - TORX® 5 PUNTE C/FORO
- 1 PORTA INSERTO **MAGNETICO** SGANCIO RAPIDO

attacco: 1/4"

FEIMEC articolo	Descrizione	Immagine	Quantità
BIT-36 TP	BOX PLASTICA		1
BIT-36 TP E	ESPOSITORE 6 BOX		1



- BOX 28 PEZZI
- INSERTI PH - PZ - TAGLIO - BRUGOLA TORX® C/FORO - XZN®
- 1 CRICCHETTO PORTA INSERTI
- 1 PORTA INSERTO **MAGNETICO** SGANCIO RAPIDO

attacco: 1/4"

FEIMEC articolo	Descrizione	Immagine	Quantità
BIT-28	BOX PLASTICA		1
BIT-28 E	ESPOSITORE 6 BOX		1



ESAGONO 1/4" CV

BGS articolo	DESCRIZIONE
BCS 20820	SET 31 PEZZI, INSERTI ATT. ESAGONALE 1/4"

CARATTERISTICHE

- comprende i seguenti inserti att. esagonale 1/4":
 - Taglio: 2 - 3 - 4 - 5 - 6 mm
 - Esagonali: 2-3-4-5-6-7-8 mm
 - Torx: TX10 - TX15 - TX20 - TX25 - TX27 - TX30 - TX35 TX40
 - PH: PH0 - PH1 - PH2 - PH2 - PH3
 - PZ: PZ0 - PZ1 - PZ2 - PZ2 - PZ3
- portainseri magnetico, att. 1/4"
- in box con clip da cintura
- peso 250 g



PENTALOBATA CON FORO TORXplus® PRO+ CV

BGS articolo	DESCRIZIONE
BGS 4993	SET 23 PEZZI, INSERTI TORX PLUS E 5 PUNTE CON FORO

CARATTERISTICHE

- adatto per viti Torx PLUS
- comprende:
 - porta inserti attacco 1/4"
 - adattatore porta inserti attacco 1/4"
 - adattatore porta inserti attacco 1/2"
- inserti 5 punte pentalobati con foro (TPH): TP 10H, 15 H, 20H, 25H, 30H, 40H, 45H, 50H, 55H, 60H
- inserti 6 punte Torx plus senza foro (TPS): TPS 10, 15, 20, 25, 30, 40, 45, 50, 55, 60
- peso 420 g



GHIERA DI MANOVRA PER SPAZI RIDOTTI



OGNI IMPRONTA UN COLORE

COLOR BIT BOX 32 PEZZI CON:
 - CRICCHETTO CON GHIERA DI MANOVRA PER SPAZI RIDOTTI
 - PORTAINSERI
 - CLIP

attacco: 1/4"

FEIMEC articolo	Descrizione	Immagine	Quantità
BIT 370 COLOR	BOX PLASTICA 32 PEZZI		1
15614	CRICCHETTO DI RICAMBO		1



OGNI IMPRONTA UN COLORE



BGS articolo	DESCRIZIONE
BGS 4816	SET 32 PEZZI, INSERTI COLORATI

CARATTERISTICHE

- acciaio S2
- ogni impronta un colore
- 30 inserti, lunghezza 25 mm:
 - Taglio: 3-4-5-6 mm
 - PH: 1-2-2-3
 - PZ: 1-2-2-3
 - Esagono: 3-4-5-6 mm
 - Torx: TX10-15-20-25-27-30-40
 - Torx c/foro: TH10-15-20-25-27-30-40
- 1 adattatore portabussole
- 1 portainseri a sgancio rapido
- peso 340 g



BGS articolo	DESCRIZIONE
BGS 784	SET 11 PEZZI, INSERTI TORX ATTACCO 1/4"

CARATTERISTICHE

- attacco esagonale 1/4"
- Torx: TX 7-8-9-10-15-20-25-27-30-40-45
- peso 70 g



BGS articolo	DESCRIZIONE
BGS 786	SET 11 PEZZI, INSERTI TORX C/FORO

CARATTERISTICHE

- 6 inserti attacco 1/4" esagonale TORX c/foro: TH10, TH15, TH20, TH25, TH27, TH30
- 3 inserti attacco 5/16" TORX c/foro: TH40, TH45, TH50
- 1 adattatore 1/4" quadro - 1/4" esagonale
- 1 adattatore 3/8" quadro - 5/16" esagonale
- peso 130 g

DISPONIBILI ANCHE IN ESPOSITORE DA 6 PEZZI



OGNI IMPRONTA UN COLORE

COLOR BIT BOX 32 PEZZI CON CLIP

attacco: 1/4"

FEIMEC articolo	Descrizione	Immagine	Quantità
BIT 320 COLOR	BOX PLASTICA 32 PEZZI CON CLIP		1



- BOX CONTAINER 36 PEZZI
- INSERTI PH - PZ - TAGLIO - BRUGOLA - TORX®
- 1 PORTA INSERTO **MAGNETICO**

attacco: 1/4"

FEIMEC articolo	Descrizione	Immagine	Quantità	Prezzo
BIT-4900	BOX PLASTICA		1	€uro





BGS articolo	DESCRIZIONE
BGS 20810	SET 33 PEZZI, INSERTI SPECIALI LUNGHEZZA 50 MM
CARATTERISTICHE	
<ul style="list-style-type: none"> • attacco da 1/4" • lunghezza 50 mm • con portainseriti magnetico • su supporto in plastica • contenuto: <ul style="list-style-type: none"> - inserti Torx: da TX10 a TX40 - inserti Esagonali: da 2 a 6 mm - inserti PZ: 0 - 1 - 2 - 3 - inserti PH: 0 - 1 - 2 - 3 - inserti Taglio: da 3 a 7 mm • peso 430 g 	





BGS articolo	DESCRIZIONE
BGS 763	SET 32 PEZZI, INSERTI SPECIALI LUNGHEZZA 35 MM
CARATTERISTICHE	
<ul style="list-style-type: none"> • per viti di sicurezza • attacco da 1/4" • lunghezza 35 mm • idonei per uso con avvitatori • contenuto: <ul style="list-style-type: none"> - Torx c/foro: TH8-10-15-20-25-27-30-35-40 - Esagono c/foro: 2-2,5-3-4-5-6 mm - Torq-set: 6-8-10 mm - Spanner: 4-6-8-10 mm - Tri-wing: 1-2-3-4 - PZ: 1-2-3 - PH: 1-2 - Taglio: 6 mm - 1 portainseriti magnetico • peso 260 g 	





BGS articolo	DESCRIZIONE
BGS 762	SET 32 PEZZI, INSERTI SPECIALI LUNGHEZZA 75 MM
CARATTERISTICHE	
<ul style="list-style-type: none"> • per viti di sicurezza • attacco da 1/4" • lunghezza 75 mm • idonei per uso con avvitatori • contenuto: <ul style="list-style-type: none"> - Torx c/foro: TH8-10-15-20-25-27-30-35-40 - Esagono c/foro: 2-2,5-3-4-5-6 mm - Torq-set: 6-8-10 mm - Spanner: 4-6-8-10 mm - Tri-wing: 1-2-3-4 - PZ: 1-2-3 - PH: 1-2 - Taglio: 6 mm • peso 640 g 	





BGS articolo	DESCRIZIONE
BGS 765	SET 100 PEZZI, INSERTI
CARATTERISTICHE	
<ul style="list-style-type: none"> • 1 portainseriti magnetico, lunghezza 60 mm • 1 inserto per occhielli • 2 adattatori porta bussola: 1/4" esagonale x 1/4" quadro maschio • 1 portainseriti senza gambo per avvitatori • 95 inserti: Taglio, Ph, Torx, Pz, Esagonali, XZN, Robertson, Spanner®, Torque®, Tri Wing®, Clutch • peso 720 g 	
RICAMBI	
BGS articolo	DESCRIZIONE
BGS 765-LEER	CASSETTA VUOTA





BGS articolo	DESCRIZIONE	
BIT-99	BOX PLASTICA	1

attacco: 1/4"

- BOX 99 PEZZI
- INSERTI CON TUTTE LE IMPRONTE
- 1 CRICCHETTO PORTA INSERTI
- 1 MINI IMPUGNATURA PORTA INSERTI MAGNETICA
- 1 PORTA INSERTI MAGNETICO





BGS articolo	DESCRIZIONE	
BIT-138	BOX PLASTICA	1

attacco: 1/4"

- BOX 138 PEZZI
- INSERTI CON TUTTE LE IMPRONTE LUNGH. 25/50 MM
- TORX® 5 PUNTE C/FORO DA TP 10 A 50
- CHIAVI A BUSSOLA
- IMPUGNATURA PORTA INSERTI MAGNETICA

MILLIMETRI
E POLLICI



CV

PRO+

BGS articolo	DESCRIZIONE
BGS 20100	SET 121 PEZZI, INSERTI + IMPUGNATURA

CARATTERISTICHE

- impugnatura portainseriti, lunghezza 200 mm
- portainseriti, inserto per occhielli, adattatore porta bussola
- **20 chiavi a bussola lunghezza 38 mm in millimetri e pollici:**
 - 4-5-6-7-8-9-10-11-12-13 mm
 - 5/32" - 3/16" - 7/32" - 1/4" - 9/32" - 11/32" - 5/16" - 3/8" - 7/16" - 1/2"
- 67 inserti lunghezza 25 mm:
 - **5 Punte con foro:** TS10-15-20-25-27-30-40-45-50
 - **Taglio:** 3-4-4.5-5-5.5-6-6.5-7-8 mm
 - **PH** 00-0-1-2-3
 - **PZ** 00-0-1-2-3
 - **Esagono:** 1.5-2-2.5-3-4-5-5.5-6-8 mm
 - **Esagono in pollici:** 1/16"-5/64"-3/32"-7/64"-1/8" - 9/64"-5/32"-3/16" - 7/32"-1/4"
 - **Torx:** TX5-TX6-TX7-TX8-TX9-TX10-TX15-TX20-TX25-TX27-TX30-TX40-TX45
 - **XZN:** M5-M6-M8
 - **Quadro maschio:** S0-S1-S2-S3
 - **Esagono con foro:** 2-2.5-3-4-5-6 mm
 - **Spanner** 4-6-8-10
 - **Tri-Wing** 1-2-3-4
 - **Torx c/foro** TH: 8-10-15-20-25-27-30-35-40
 - **Clutch** C1-C2-C3
 - **Torque-set:** 6-8-10
- peso 1,2 Kg

MILLIMETRI
E POLLICI



PRO+

ESAGONO
1/4"

BGS
articolo
BGS 20103

DESCRIZIONE

SET 208 PEZZI, INSERTI PER VITI DI SICUREZZA

CARATTERISTICHE

- 139 inserti, attacco esagonale 1/4", lunghezza 25 mm:
 - 13 inserti Taglio: 2 - 2,5 - 3 - 3 - 3,5 - 4 - 4 - 4,5 - 5 - 5 - 5,5 - 6 - 6,5 - 7 - 8 mm
 - 18 inserti PH: PH0 - PH0 - PH1 - PH2 - PH3 - PH4
 - 17 inserti PZ: PZ00 - PZ0 - PZ0 - PZ1 - PZ2 - PZ3 - PZ4
 - 13 inserti Torx: TX5 - TX6 - TX7 - TX8 - TX9 - TX10 - TX15 - TX20 - TX25 - TX27 - TX30 - TX40 - TX45
 - 14 inserti Torx c/ foro: TH5 - TH6 - TH7 - TH8 - TH9 - TH10 - TH15 - TH20 - TH25 - TH27 - TH30 - TH40 - TH45
 - 9 inserti Torx Plus: TS10 - TS15 - TS20 - TS25 - TS27 - TS30 - TS30 - TS40 - TS45 - TS50
 - 12 inserti Esagonali: 1,5 - 2 - 2,5 - 3 - 3 - 3,5 - 4 - 4,5 - 5 - 5 - 5,5 - 6 - 7 - 8 mm
 - 10 inserti Esagonali in Pollici: 1/16" - 5/64" - 3/32" - 7/64" - 1/8" - 9/64" - 5/32" - 3/16" - 7/32" - 1/4"
 - 6 inserti Esagonali c/ foro: 2 - 2,5 - 3 - 3 - 4 - 5 - 6 mm
 - 6 inserti Esagonali c/ foro in Pollici: 5/64" - 3/32" - 7/64" - 1/8" - 9/64" - 5/32"
 - 4 inserti Quadro: 0 - 1 - 2 - 3
 - 3 inserti Clutch: C1 - C2 - C3
 - 4 inserti Spanner: 4 - 6 - 8 - 10
 - 3 inserti XZN: M5 - M6 - M8
 - 3 inserti Torq-set: 6 - 8 - 10 mm
 - 4 inserti Tri-wing: 1 - 2 - 3 - 4
- 28 inserti, attacco esagonale 1/4", lunghezza 50 mm:
 - 5 inserti Taglio: 2,5 - 3 - 4 - 5 - 6 mm
 - 3 inserti PH: PH1 - PH2 - PH3
 - 3 inserti PZ: PZ1 - PZ2 - PZ3
 - 7 inserti Torx c/ foro: TH10 - TH15 - TH20 - TH25 - TH27 - TH30 - TH40
 - 3 inserti Torq-set: 6 - 8 - 10 mm
 - 4 inserti Spanner: 4 - 6 - 8 - 10
 - 4 inserti Tri-wing: 1 - 2 - 3 - 4
- 18 inserti, attacco esagonale 1/4", lunghezza 75 mm:
 - 5 inserti Taglio: 2,5 - 3 - 4 - 5 - 6 mm
 - 3 inserti PH: PH1 - PH2 - PH3
 - 3 inserti PZ: PZ1 - PZ2 - PZ3
 - 7 inserti Torx c/ foro: TH10 - TH15 - TH20 - TH25 - TH27 - TH30 - TH40
- 10 bussole esagonali, attacco quadro 1/4": SW 4 - 5 - 6 - 7 - 8 - 9 - 10 - 11 - 12 - 13 mm
- 10 bussole esagonali in pollici, attacco quadro 1/4": 5/32" - 3/16" - 7/32" - 1/4" - 9/32" - 5/16" - 11/32" - 3/8" - 7/16" - 1/2"
- 1 impugnatura portainseriti, attacco esagonale 1/4", lunghezza 200 mm (BGS 217)
- 1 portainseriti magnetico
- 1 adattatore per bussole, attacco esagonale 1/4" - attacco quadro 1/4", lunghezza 30 mm (BGS 8202)
- peso: 2,2 kg

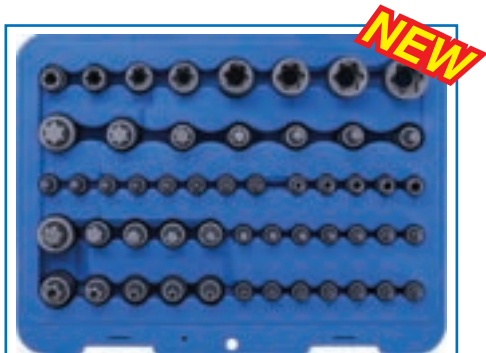

BGS articolo	DESCRIZIONE
BGS 9839	SET 52 PEZZI, BUSSOLE E INSERTI TORX, TORX CON FORO E TORX-PLUS

CARATTERISTICHE

- comprende:
- 12 chiavi a bussola, Torx c/foro:
 - attacco 1/4": TH8 - TH10 - TH15 - TH20 - TH25 - TH27 - TH30
 - attacco 3/8": TH40 - TH45 - TH50 - TH55
 - attacco 1/2": TH60
- 15 chiavi a bussola, Torx:
 - attacco 1/4": TX6 - TX8 - TX10 - TX15 - TX20 - TX25 - TX27 - TX30
 - attacco 3/8": TX40 - TX45 - TX47 - TX50 - TX55
 - attacco 1/2": TX60 - TX70
- 12 chiavi a bussola Torx-Plus:
 - attacco 1/4": TP8 - TP10 - TP15 - TP20 - TP25 - TP27 - TP30
 - attacco 3/8": TP40 - TP45 - TP50 - TP55
 - attacco 1/2": TP60
- 13 bussole Torx Femmina tipo E:
 - attacco 1/4": E4 - E5 - E6 - E7 - E8
 - attacco 3/8": E10 - E12 - E14 - E16
 - attacco 1/2": E18 - E20 - E22 - E24
- peso: 2,3 kg

OGNI IMPRONTA UN COLORE
COLOR BIT BOX 71 PEZZI

attacco: 1/4"

BGS articolo	Descrizione	
BIT 710 COLOR	BOX PLASTICA 71 PEZZI	1



BGS articolo	DESCRIZIONE
BIT PHONE	SET 21 MICRO-INSERTI COLORATI + IMPUGNATURA PORTAININSERTI

CARATTERISTICHE

- il primo kit di inserti per cellulari, pc e tablet
- set 21 micro-inserti colorati + impugnatura portaininserti
- contenuto:
 - Ph0000, Ph000
 - Taglio: 0,8, 1,2, 1,5
 - Torx: TX1, TX2, TX3, TX4, TX5
 - Torx c/ foro: TH6, TH7, TH8
 - 5 punte: T1, T2, T3, T4, T5
 - 5 punte c/ foro: T6, T7, T8



BGS articolo	DESCRIZIONE
BGS 20122	SET 22 PEZZI, IMPUGNATURA PORTAININSERTI A "T" A CRICCHETTO, CON INSERTI

CARATTERISTICHE

- impugnatura a cricchetto con portainseriti a sgancio rapido
- attacco esagonale 1/4"
- con magnete
- funzione cricchetto sinistra / destra, con blocco
- comprende:
 - 3 inserti PH: PH0 - PH1 - PH2
 - 3 inserti PZ: PZ0 - PZ1 - PZ2
 - 3 inserti Taglio: 3 - 4 - 5 mm
 - 3 inserti Torx: TX10 - TX15 - TX20
 - chiavi a bussola Esagonali: 6 - 7 - 8 - 9 - 10 - 11 - 12 - 13 mm
 - 1 impugnatura a "T" con cricchetto reversibile, lunghezza 105 mm
 - 1 porta-inserti magnetico, 60 mm
- peso 400 g



	BGS articolo BGS 92540	DESCRIZIONE SET 3 PEZZI, BUSSOLA UNIVERSALE, ADATTATORE E CHIAVE A CRICCHETTO REVERSIBILE
--	--	--

- CARATTERISTICHE**
- adatta a tutte le impronte esagonali anche in pollici
 - non adatto per l'utilizzo su bulloni ruote
 - comprende:
 - 1 bussola universale, attacco 3/8", 7 - 19 mm
 - 1 adattatore portabussole, attacco quadro femmina 3/8" - attacco esagonale 1/4"
 - 1 impugnatura a T a cricchetto, reversibile, attacco esagonale 1/4"
 - peso 320 g



	BGS articolo BGS 92533	DESCRIZIONE SET 3 PEZZI, BUSSOLA UNIVERSALE 9-21 MM, CON ADATTATORI
--	--	--

- CARATTERISTICHE**
- adatta a tutte le impronte esagonali anche in pollici
 - non adatto per l'uso su bulloni di sicurezza per cerchi ruota
 - comprende:
 - bussola universale, attacco 3/8", 9 - 21 mm (BGS 2533)
 - riduzione Femmina 1/2" - Maschio 3/8" (BGS 270)
 - adattatore per bussola, attacco esagonale 1/4", quadro maschio 3/8" (BGS 9685-2)
 - peso: 280 g



	BGS articolo BGS 35820	DESCRIZIONE SET 13 PEZZI, IMPUGNATURA CON INSERTI
--	--	--

- CARATTERISTICHE**
- impugnatura portainseriti ergonomica con 12 inserti in custodia
 - comprende i seguenti inserti:
 - Taglio: 3 - 4 - 5 - 6 mm
 - PZ: 0 - 1 - 2 - 3
 - Torx: TX10 - TX15 - TX20 - TX25
 - peso 190 g



	BGS articolo BGS 20131	DESCRIZIONE SET 31 PEZZI, IMPUGNATURA PORTAINSERITI FLESSIBILE CON 30 INSERTI
--	--	--

- CARATTERISTICHE**
- ideale per aree di difficile accesso
 - impugnatura in materiale bi-componente
 - attacco: 1/4" esagonale
 - lunghezza: 290 mm
 - comprende:
 - 1 impugnatura portainseriti flessibile
 - 20 inserti, lunghezza: 25 mm
 - 4 inserti Taglio: 3, 4, 5, 6 mm
 - 4 inserti PH: PH0 - PH1 - PH2 - PH3
 - 7 inserti Torx: TX10 - TX15 - TX20 - TX25 - TX27 - TX30 - TX40
 - 5 inserti Esagonali: 2 - 2.5 - 3 - 4 - 5 mm
 - 10 chiavi a bussola esagonali 38 mm: 4 - 5 - 6 - 7 - 8 - 9 - 10 - 11 - 12 - 13 mm
 - peso 550 g



	BGS articolo BGS 35831	DESCRIZIONE SET 31 PEZZI, IMPUGNATURA PORTAINSERITI CON 30 INSERTI
--	--	---

- CARATTERISTICHE**
- impugnatura portainseriti ergonomica con 30 inserti
 - impugnatura portainseriti magnetica
 - supporto portainseriti richiudibile con gancio per appendere
 - supporto con magnete interno per trattenere l'impugnatura portainseriti
 - comprende:
 - 7 inserti, att. esagonale 1/4", Esagonali: 2 - 2.5 - 3 - 4 - 5 - 6 - 8 mm
 - 8 inserti, att. esagonale 1/4", Torx: TX9 - TX10 - TX15 - TX20 - TX25 - TX27 - TX30 - TX40
 - 5 inserti, att. esagonale 1/4", PH: 0 - 1 - 2 - 2 - 3
 - 5 inserti, att. esagonale 1/4", PZ: 0 - 1 - 2 - 2 - 3
 - 5 inserti, att. esagonale 1/4", Taglio: 3 - 4 - 5 - 6 - 7 mm
 - 1 impugnatura portainseriti, att. esagonale 1/4", lunghezza 190 mm, con magnete
 - peso 320 g



OGNI IMPRONTA UN COLORE

ESAGONO 1/4" PRO+ CV

1/4" PHILLIPS POZIDRIV TAGLIO TORX ESAGONO QUADRO BUSSOLE ESAGONALI

BGS articolo	DESCRIZIONE
BGS 20138	SET 38 PEZZI, INSERTI E BUSSOLE, CON IMPUGNATURA PORTAINSERI A CRICCHETTO REVERSIBILE



OGNI IMPRONTA UN COLORE

ESAGONO 1/4" PRO+ CV

BGS articolo	DESCRIZIONE
BGS 9384	SET 28 PEZZI, INSERTI COLORATI + BUSSOLE

CARATTERISTICHE

- bussole esagonali, cromate satinare, zigrinate: 6-8-10-11-12-13 mm
- adattatore: 1/4" esagonale maschio - 1/4" quadro maschio
- portainseri attacco esagonale 1/4"
- 20 inserti colorati attacco esagonale 1/4":
 - Taglio: 4 - 6 mm
 - PH: 1 - 2 - 3
 - PZ: 1 - 2 - 3
 - Esagono: 4 - 5 mm
 - Torx: TX10 - TX15 - TX20 - TX25 - TX30
 - Torx con foro: TH10 - TH15 - TH20 - TH25 - TH30
- peso 410 g



OGNI IMPRONTA UN COLORE

ESAGONO 4 mm.

OGNI IMPRONTA UN COLORE

- SERIE 30 INSERTI DI PRECISIONE COLORATI CON IMPUGNATURA
- PH000 - PH00 - PH0 - PH1
- PZ0 - PZ1
- TAGLIO 1 - 1,5 - 2 - 2,5 - 3 - 3,5 - 4 MM
- TORX® TX 4 - 5 - 6 - 7 - 8 - 9 - 10 - 15 - 20
- ESAGONO 0,7 - 0,9 - 1,3 - 1,5 - 2 - 2,5 - 3 - 4 MM

attacco: 4 mm

FERMEC articolo	Descrizione	
BIT 130 COLOR	BOX 30 PEZZI	1

NEW



TAGLIO PHILLIPS TORX

BGS articolo	DESCRIZIONE
BGS 20817	SET 17 PEZZI, INSERTI DI PRECISIONE & CHIAVE UNIVERSALE, CON IMPUGNATURA A CRICCHETTO REVERSIBILE

CARATTERISTICHE

- comprende:
 - 1 impugnatura portainseri a cricchetto reversibile, att. 1/4", lunghezza 165 mm
 - 1 porta-inserti magnetico, att. 1/4", per inserti 4 mm
 - inserti di precisione, attacco 4 mm:
 - Taglio: 2,5 - 3,0 - 4,0 mm
 - PH: PH00 - PH0
 - Torx: TX5 - TX6 - TX8
 - inserti attacco 1/4":
 - Taglio: 5 - 6 mm
 - PH: PH1 - PH2
 - Torx: TX15
 - quadro femmina: 2 mm
 - 1 chiave a bussola universale, attacco 1/4" esagonale, 7 - 19 mm



OGNI IMPRONTA UN COLORE

BGS articolo	DESCRIZIONE
BGS 20831	SET 31 PEZZI, INSERTI DI PRECISIONE

CARATTERISTICHE

- contenuto:
 - impugnatura portainseri
 - inserti Taglio: 1,5 - 2,0 - 2,5 - 3,0 - 3,5 - 4,0 mm
 - inserti PH: 00 - 0 - 1 - 2
 - inserti Torx: TX 4-5-6-7-8-12-15-20
 - inserti Esagonali: 1,0-1,3-1,5-2,0-2,5-3,0-4,0 mm
 - inserto Spanner: 2,6 mm
 - inserto Tri-wing: 3,0 mm
 - inserto Stella: 2,0 mm
 - inserto Triangolare: 3,0 mm
 - inserto Punzone: 1,0 mm
- peso 160 g



NEW



BGS articolo	DESCRIZIONE
BGS 20840	SET 10 PEZZI, INSERTI DI PRECISIONE

CARATTERISTICHE

- adatto per una vasta gamma di applicazioni elettroniche
- pratico e robusto
- per lavori di precisione su smartphone, tablet, computer, occhiali, orologi e molto altro
- impugnatura antiscivolo con superficie ondulata
- lunghezza: 27 mm
- materiale: alluminio / cromo-vanadio
- comprende:
 - 1 impugnatura per cacciavite, magnetica, con clip da cintura, con serbatoio sul retro, lunghezza: 110 mm
 - 3 inserti, att. esagonale 4 mm, Taglio 1,5 - 2 - 2,5 mm
 - 3 inserti, att. esagonale 4 mm, PH00 - PH0 - PH1
 - 3 inserti, att. esagonale 4 mm, Torx TX6 - TX7 - TX8
- peso 50 g

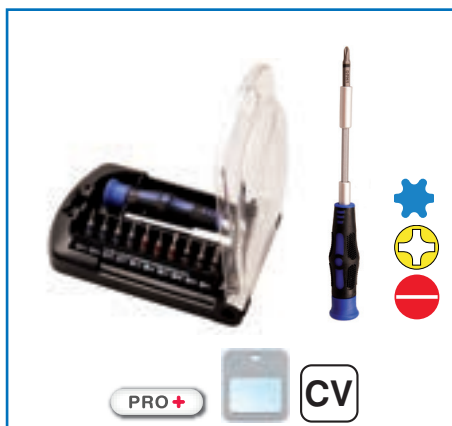

PRO+ CV

BGS articolo	DESCRIZIONE
BGS 8452	SET 11 PEZZI, INSERTI DI PRECISIONE

CARATTERISTICHE

- contenuto:
 - impugnatura ergonomica;
 - prolunga lunghezza 70 mm, con asta esagonale;
 - inserti Torx: TX4, TX5, TX6, TX7
 - inserti Taglio: 1,5 - 2,0 - 2,5 mm
 - inserti PH: 00, 0, 1
- inserti con attacco esagonale da 4 mm e codice colore
- peso 170 g



NEW



BGS articolo	DESCRIZIONE
BGS 20821	SET 21 PEZZI, INSERTI DI PRECISIONE, CON VASCHETTA MAGNETICA

CARATTERISTICHE

- 1 impugnatura portainseriti, magnetica, con clip, lunghezza: 110 mm
- 1 prolunga, esagono 4 mm, lunghezza 115 mm
- 18 inserti di precisione esagono 4 mm, lunghezza 27 mm:
 - Taglio: 1,5 - 2 - 2,5 - 3 - 3,5 - 4 mm
 - PH: PH00 - PH0 - PH1 - PH2
 - Esagonali: 2 - 2,5 mm
 - Torx: TX5 - TX6 - TX7 - TX8 - TX9 - TX10
- 1 vaschetta magnetica, 95 x 65 x 20 mm, portata massima 400 g



NEW



BGS articolo	DESCRIZIONE
BGS 20130	SET 30 PEZZI, BUSSOLE E INSERTI ATTACCO 1/4"

CARATTERISTICHE

- in cassetta in plastica
- comprende:
 - 1 portainseriti magnetico, attacco esagonale 1/4" x impronta esagonale 4 mm
 - 3 inserti di precisione, attacco 4 mm PH: PH00 - PH0 - PH1
 - 3 inserti di precisione, attacco 4 mm, Taglio: 2 - 3 - 4 mm
 - 2 inserti di precisione, attacco 4 mm, Torx: TX10 - TX20
 - 3 inserti attacco 1/4" PH: PH0 - PH1 - PH2
 - 2 inserti attacco 1/4" PZ: PZ0 - PZ1
 - 3 inserti attacco 1/4" Taglio: 4 - 5 - 6 mm
 - 2 inserti attacco 1/4", Torx: TX10 - TX15
 - 3 inserti attacco 1/4" Esagonali: 4 - 5 - 6 mm
 - 1 impugnatura a cricchetto reversibile attacco esagono femmina 1/4", lunghezza 125 mm
 - 6 bussole esagonali, attacco 1/4", misure: 5 - 6 - 7 - 8 - 9 - 10 mm
 - 1 adattatore portabussole attacco esagonale 1/4" - quadro maschio 1/4", lunghezza 25 mm
- peso: 390 g



BGS articolo	DESCRIZIONE
BGS 20823	SET 23 PEZZI, INSERTI DI PRECISIONE

CARATTERISTICHE

- particolarmente adatto per lavori di precisione
- inserti attacco 4 mm delle seguenti misure:
 - Taglio: 1,5 - 2,0 - 2,5 - 3,0 mm
 - Torx: TX 5 - TX 6 - TX 7 - TX 8 - TX 15
 - Torx c/ foro: TH 8 - TH 10 - TH 15
 - Spanner: 2,5 mm
 - Tri-wing: 3,0 mm
 - Triangolare da 3,0 mm
 - 5 inserti PH e PZ
- portainseriti con impugnatura bi-componente
- pinzetta lunghezza 120 mm
- peso 170 g



- CACCIAVITE A PENNA **ESTENSIBILE**
- 12 INSERTI DI PRECISIONE
PH000 - PH00 - PH0
TAGLIO MM 1,5-2-2,5
TORX® TX 4-5-6-7-8-10
- IDEALE PER CELLULARI - COMPUTER -
ELETTRONICA - OCCHIALI...

DESCRIZIONE	ESPOSITORE
3412	1
3412 E	1



DESCRIZIONE
SET 42 PEZZI, INSERTI E PUNTE

CARATTERISTICHE
<ul style="list-style-type: none"> • 14 inserti, lunghezza 50 mm: - Taglio 5 e 6 mm - Esagono 2, 2,5, 3, 4, 5, 6 mm - Torx: TX10, TX15, TX20, TX25, TX30, TX40 • 7 bussole lunghezza 35 mm esagonali: 5,5, 6, 7, 8, 10, 12, 13 mm • 1 portainseri magnetico • 5 inserti doppia punta, lunghezza 110 mm: - 3 x PH2-PH2 - 2 x PZ2-PZ2 • 6 inserti doppia punta lunghezza 65 mm: - PZ 1, 2, 3 - PH 1; - 3 X Taglio 5 mm • 2 inserti lunghezza 110 mm PH 2 e PZ 2 • 1 adattatore 65 mm con attacco quadro da 1/4" • 5 punte con attacco da 1/4": 1,5, 2,5, 3, 4, 5 mm • peso 870 g



DESCRIZIONE
SET 51 PEZZI, INSERTI PER VITI DI SICUREZZA

CARATTERISTICHE
<ul style="list-style-type: none"> • grazie al particolare profilo svasato permettono l'uso anche in spazi particolarmente ristretti • attacco esagonale da 1/4" • 1 portainseri magnetico • Inserti, lunghezza 75 mm: - Torx c/foro: TH8-10-15-20-25-27-30-35-40 - Torx: TX10-15-20-25-30 - Esagono c/foro: 2-2,5-3-4-5-6 mm - Esagono: 4-5-6 mm - Taglio: 4-5-6 mm - PH: 1-2 - PZ: 1-2 - XZN: M5-M6-M8 - Spanner: 4-5-6-8-10 mm - Tri-wing: 1-2-3-4 mm - Torq-set: 6-8-10 mm - Quadro: S1, S2 • peso 1,3 kg

NOTE



BGS articolo	DESCRIZIONE
BGS 4810	SET 42 PEZZI, INSERTI E BUSSOLE, ATT. 1/4" E 3/8"

CARATTERISTICHE

- 1 adattatore portabussole, 50 mm, att. esag. 1/4" - quadro maschio 1/4"
- 1 porta-inserti magnetico, lunghezza 75 mm
- 36 inserti, att. 1/4":
 - 3 inserti, PH2, lunghezza 50 mm
 - 1 inserto Torx c/foro, TH15, lunghezza 50 mm
 - 2 inserti Torx c/foro, TH20, lunghezza 50 mm
 - 2 inserti Torx c/foro, TH25, lunghezza 50 mm
 - 2 inserti Quadro, S2, lunghezza 50 mm
 - 2 inserti Quadro, S2, lunghezza 50 mm
 - 1 inserto Quadro, S3, lunghezza 50 mm
 - 1 inserto Taglio, 6 mm, lunghezza 50 mm
 - 1 inserto Torx c/foro, TH15, lunghezza 25 mm
 - 3 inserti Torx c/foro, TH20, lunghezza 25 mm
 - 3 inserti Torx c/foro, TH25, lunghezza 25 mm
 - 1 inserto Torx c/foro, TH30, lunghezza 25 mm
 - 3 inserti, PH2, lunghezza 25 mm
 - 1 inserto Esagonale, 3 mm, lunghezza 25 mm
 - 1 inserto Esagonale, 4 mm, lunghezza 25 mm
 - 1 inserto Esagonale, 5 mm, lunghezza 25 mm
 - 1 inserto Esagonale, 6 mm, lunghezza 25 mm
 - 1 inserto Esagonale, 7 mm, lunghezza 25 mm
 - 1 inserto Taglio, 6 mm, lunghezza 25 mm
 - 1 inserto Taglio, 8 mm, lunghezza 25 mm
 - 2 inserti, PH1, lunghezza 25 mm
 - 2 inserti, PH2, lunghezza 25 mm
 - 2 inserti, PH3, lunghezza 25 mm
- 4 bussole, Esagonali, lunghe, att. 3/8": 8 - 9 - 10 - 12 mm
- peso 850 g



BGS articolo	DESCRIZIONE
BGS 4811	SET 55 PEZZI, INSERTI E PUNTE, ATT. 1/4"

CARATTERISTICHE

- 1 porta-inserti c/sgancio rapido, lungh. 70 mm
- 1 porta-inserti magnetico, lunghezza 77 mm
- 43 inserti, att. 1/4":
 - 2 inserti, PH2, lunghezza 50 mm
 - 1 inserto Esagonale, 5 mm, lunghezza 50 mm
 - 1 inserto Esagonale, 6 mm, lunghezza 50 mm
 - 2 inserti Torx c/foro, TH20, lunghezza 50 mm
 - 2 inserti Torx c/foro, TH25, lunghezza 50 mm
 - 2 inserti Torx c/foro, TH30, lunghezza 50 mm
 - 1 inserto Taglio, 6 mm, lunghezza 50 mm
 - 1 inserto Taglio, 8 mm, lunghezza 50 mm
 - 1 inserto Esagonale, 1.5 mm, lunghezza 25 mm
 - 2 inserti Esagonali, 2 mm, lunghezza 25 mm
 - 1 inserto Esagonale, 2.5 mm, lunghezza 25 mm
 - 2 inserti Esagonali, 3 mm, lunghezza 25 mm
 - 2 inserti Esagonali, 4 mm, lunghezza 25 mm
 - 1 inserto Esagonale, 5 mm, lunghezza 25 mm
 - 1 inserto Esagonale, 5.5 mm, lunghezza 25 mm
 - 1 inserto Esagonale, 6 mm, lunghezza 25 mm
 - 1 inserto Esagonale, 8 mm, lunghezza 25 mm
 - 1 inserto Esagonale, 6 mm, lunghezza 25 mm
 - 1 inserto Esagonale, 7 mm, lunghezza 25 mm
 - 4 inserti, PH1, lunghezza 25 mm
 - 4 inserti, PH2, lunghezza 25 mm
 - 4 inserti, PH3, lunghezza 25 mm
- 3 bussole, Esagonali, att. 1/4": 6 - 8 - 10 mm
- 7 punte HSS, att. esagonale 1/4", Ø: 1.0 - 1.5 - 2 - 2.5 - 3 - 3.2 - 5 mm
- peso 840 g

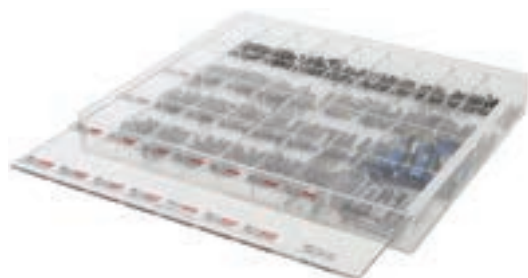

BGS 9328-LEER



BGS articolo	DESCRIZIONE
BGS 9328	ASSORTIMENTO 340 PEZZI, ESPOSITORE DA BANCO, INSERTI ATT. 1/4"

CARATTERISTICHE

- espositore in plastica acrilica trasparente rinforzata, con coperchio scorrevole
- inserti per uso manuale o con avvitatore elettrico
- comprende inserti e porta-inserti con attacco esagonale 1/4" (6,3 mm)
- dimensioni: 39 x 33 x 45 mm
- comprende:
 - 10 pezzi, inserti att. esagonale 1/4", PH1
 - 20 pezzi, inserti att. esagonale 1/4", PH2
 - 10 pezzi, inserti att. esagonale 1/4", PH3
 - 10 pezzi, inserti att. esagonale 1/4", PZ1
 - 20 pezzi, inserti att. esagonale 1/4", PZ2
 - 10 pezzi, inserti att. esagonale 1/4", PZ3
 - 10 pezzi, inserti att. esagonale 1/4", Taglio 4.5 mm
 - 20 pezzi, inserti att. esagonale 1/4", Taglio 5.5 mm
 - 10 pezzi, inserti att. esagonale 1/4", Taglio 7 mm
 - 10 pezzi, inserti att. esagonale 1/4", Taglio 8 mm
 - 10 pezzi, inserti att. esagonale 1/4", Esagonale 3 mm
 - 10 pezzi, inserti att. esagonale 1/4", Esagonale 4 mm
 - 10 pezzi, inserti att. esagonale 1/4", Esagonale 5 mm
 - 10 pezzi, inserti att. esagonale 1/4", Esagonale 6 mm
 - 10 pezzi, inserti att. esagonale 1/4", Esagonale 8 mm
 - 10 pezzi, inserti att. esagonale 1/4", Torx TX10
 - 10 pezzi, inserti att. esagonale 1/4", Torx TX15
 - 10 pezzi, inserti att. esagonale 1/4", Torx TX20
 - 10 pezzi, inserti att. esagonale 1/4", Torx TX25
 - 10 pezzi, inserti att. esagonale 1/4", Torx TX27
 - 10 pezzi, inserti att. esagonale 1/4", Torx TX30
 - 10 pezzi, inserti att. esagonale 1/4", Torx TX40
 - 10 pezzi, inserti att. esagonale 1/4", Torx con Foro TH10
 - 10 pezzi, inserti att. esagonale 1/4", Torx con Foro TH15
 - 10 pezzi, inserti att. esagonale 1/4", Torx con Foro TH20
 - 10 pezzi, inserti att. esagonale 1/4", Torx con Foro TH25
 - 10 pezzi, inserti att. esagonale 1/4", Torx con Foro TH27
 - 10 pezzi, inserti att. esagonale 1/4", Torx con Foro TH30
 - 10 pezzi, inserti att. esagonale 1/4", Torx con Foro TH40
 - 10 pezzi, portainseri att. esagonale 1/4", a sgancio rapido, 60 mm
 - 10 pezzi, portainseri att. esagonale 1/4", magnetico 60 mm
- peso 4,9 kg

RICAMBI

BGS articolo	DESCRIZIONE
BGS 9328-LEER	ESPOSITORE VUOTO

NOTE

Area with horizontal dotted lines for writing notes.